

# 209 Earl Street

## Ground Floor

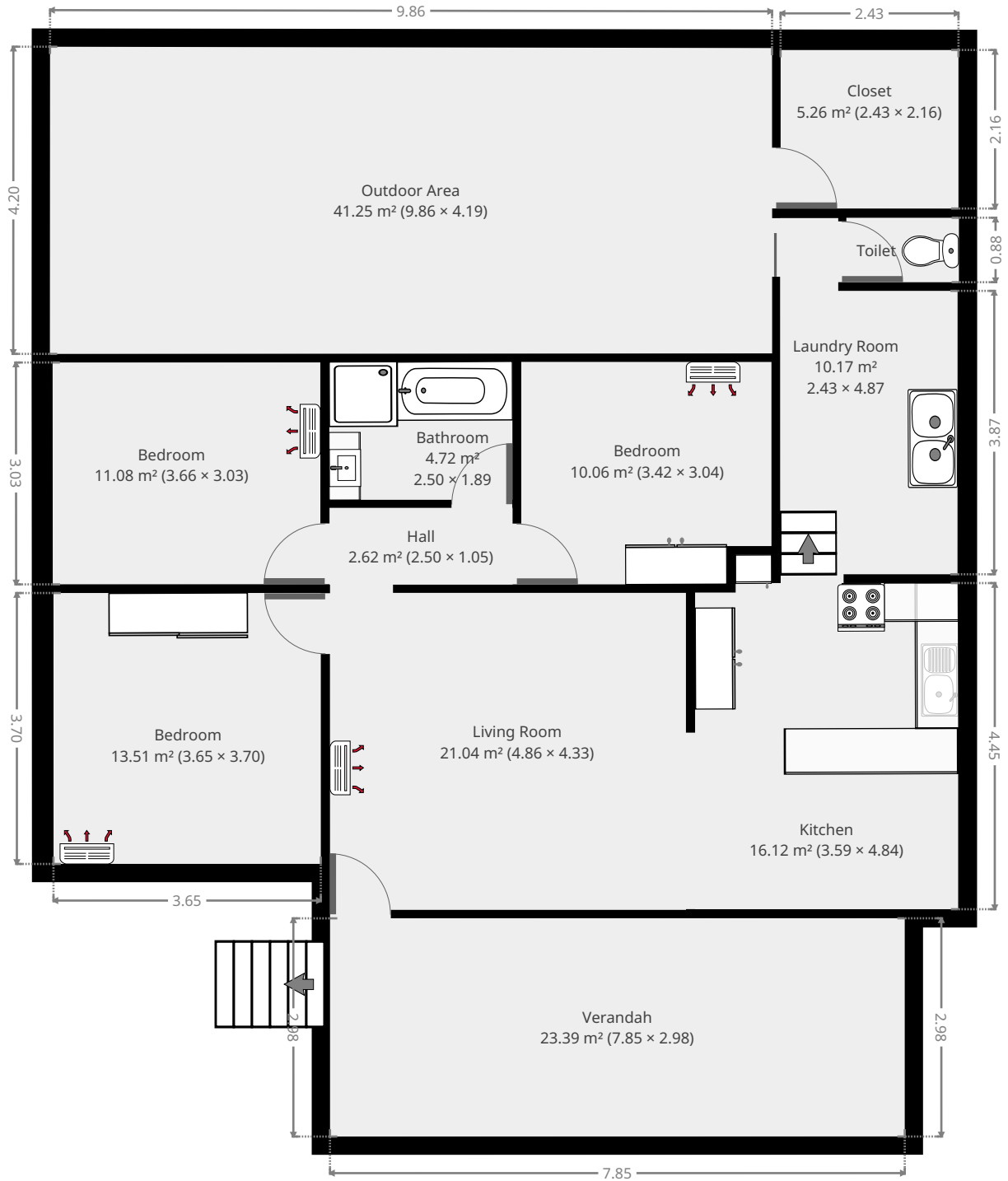

THIS FLOORPLAN IS PROVIDED WITHOUT WARRANTY OF ANY KIND. SENSOPIA DISCLAIMS ANY WARRANTY INCLUDING, WITHOUT LIMITATION, SATISFACTORY QUALITY OR ACCURACY OF DIMENSIONS.



# 209 Earl Street

## Living Room

Width: 4.33 m  
Length: 4.86 m  
Area: 21.04 m<sup>2</sup>  
Perimeter: 18.38 m

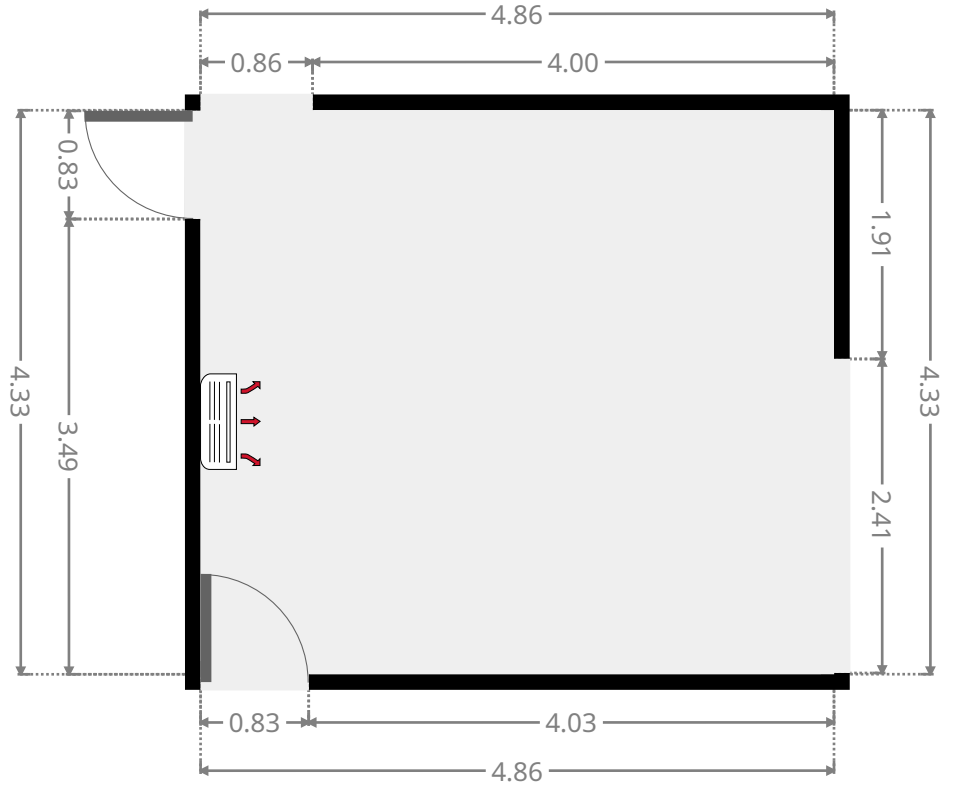
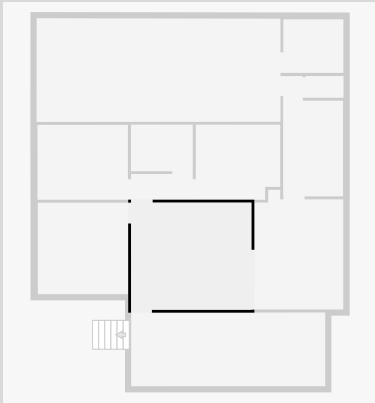

## Bedroom

Width: 3.65 m  
Length: 3.70 m  
Area: 13.51 m<sup>2</sup>  
Perimeter: 14.70 m

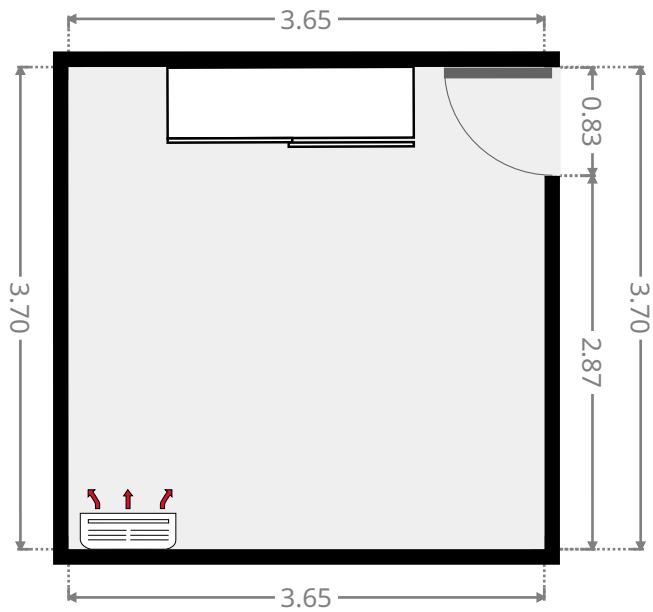
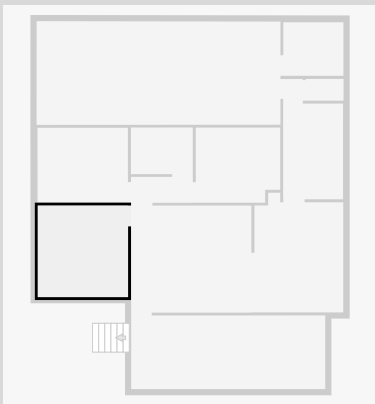

# 209 Earl Street

## Hall

Width: 1.05 m  
 Length: 2.50 m  
 Area: 2.62 m<sup>2</sup>  
 Perimeter: 7.10 m

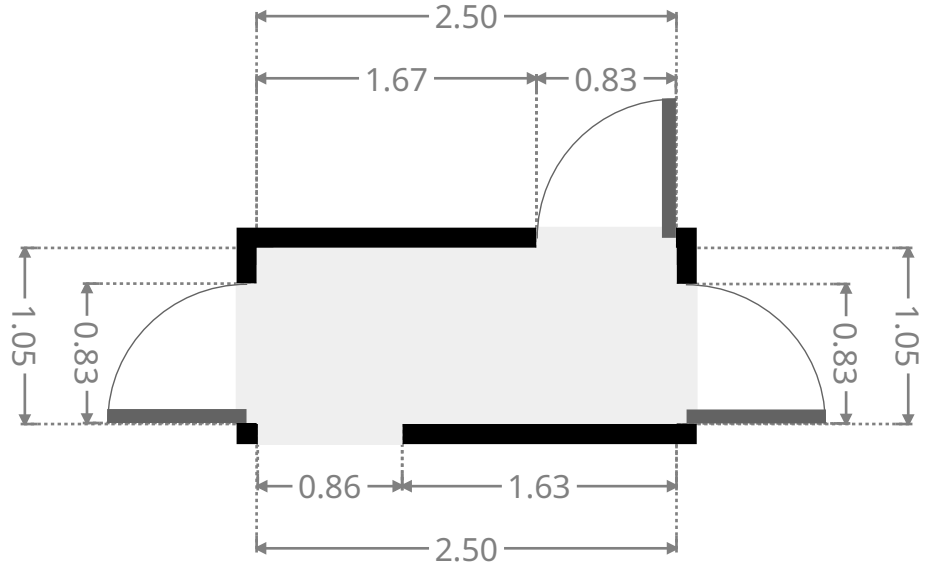
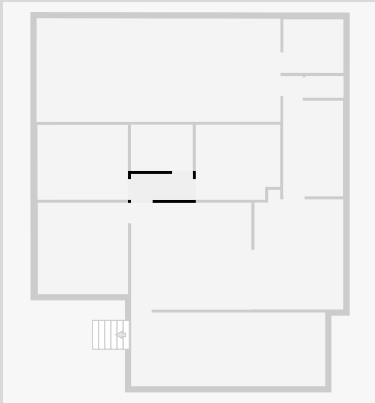

## Bedroom

Width: 3.04 m  
 Length: 3.42 m  
 Area: 10.06 m<sup>2</sup>  
 Perimeter: 12.91 m

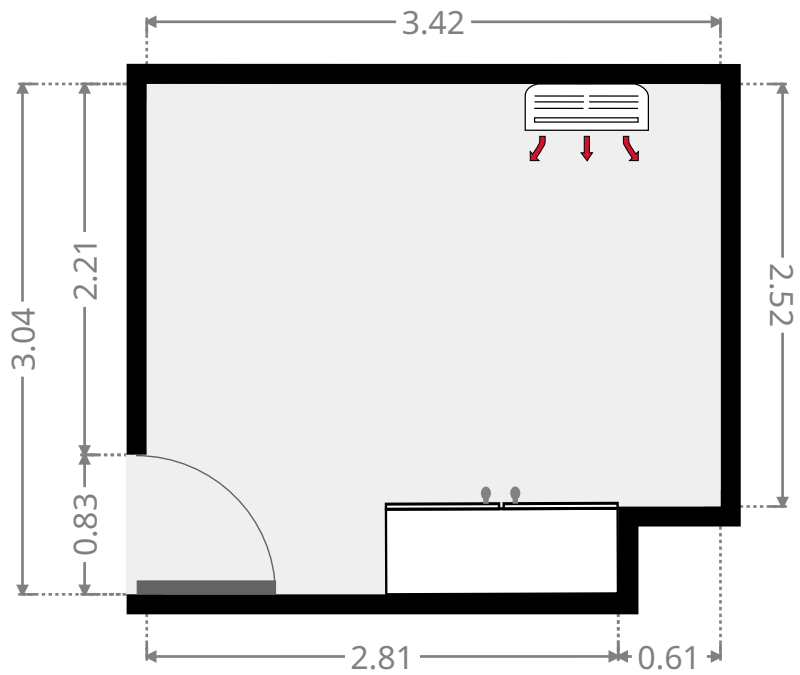
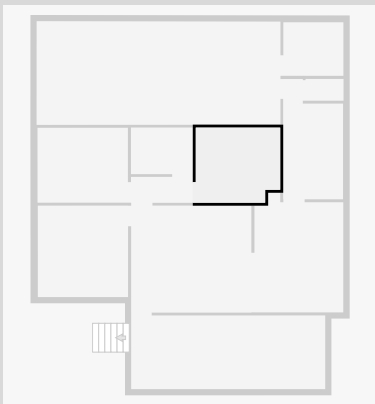

THIS FLOORPLAN IS PROVIDED WITHOUT WARRANTY OF ANY KIND. SENSOPIA DISCLAIMS ANY WARRANTY INCLUDING, WITHOUT LIMITATION, SATISFACTORY QUALITY OR ACCURACY OF DIMENSIONS.

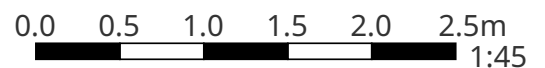

# 209 Earl Street

## Bathroom

Width: 1.89 m  
Length: 2.50 m  
Area: 4.72 m<sup>2</sup>  
Perimeter: 8.78 m

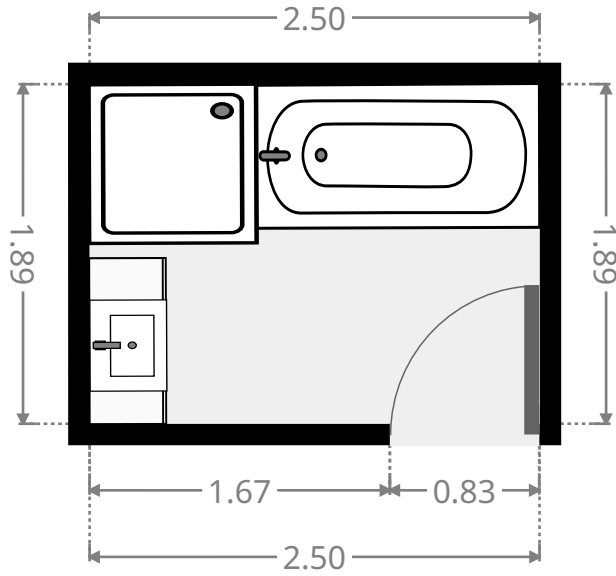
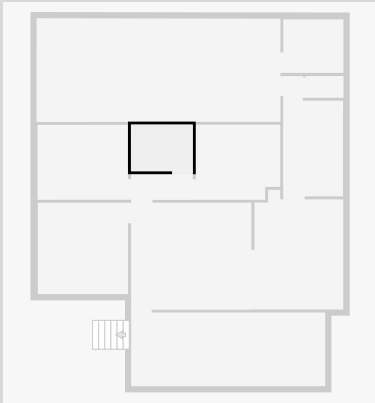

## Bedroom

Width: 3.03 m  
Length: 3.66 m  
Area: 11.08 m<sup>2</sup>  
Perimeter: 13.37 m

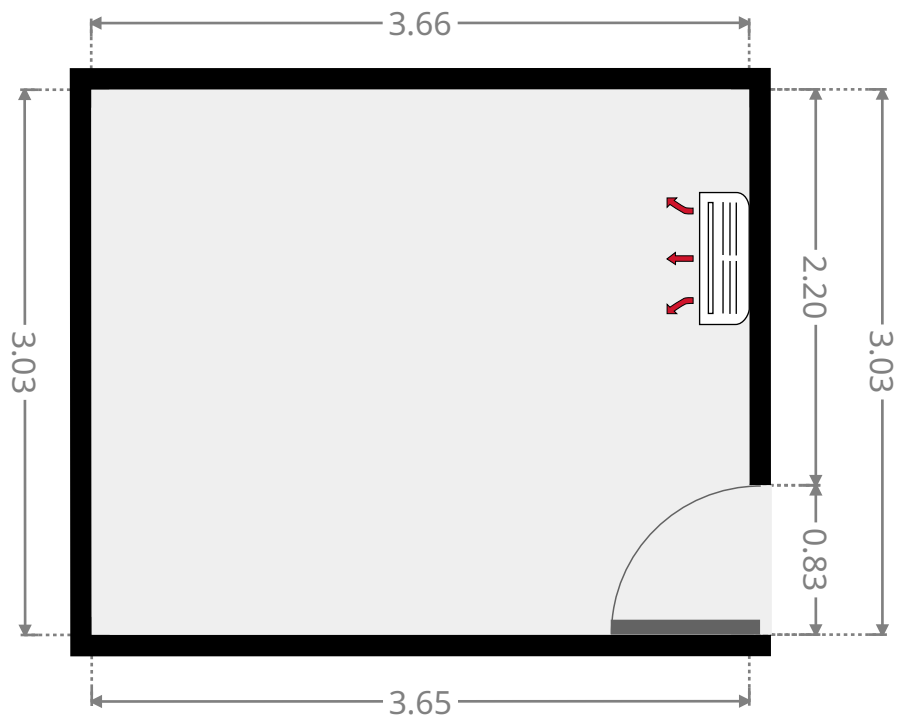
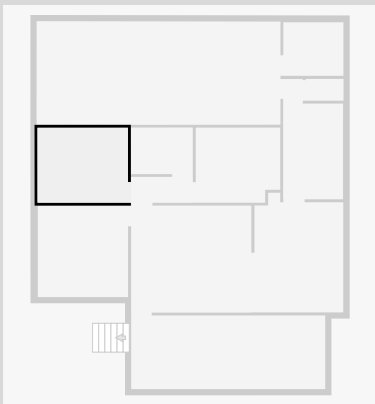

THIS FLOORPLAN IS PROVIDED WITHOUT WARRANTY OF ANY KIND. SENSOPIA DISCLAIMS ANY WARRANTY INCLUDING, WITHOUT LIMITATION, SATISFACTORY QUALITY OR ACCURACY OF DIMENSIONS.

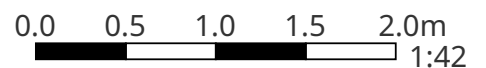

# 209 Earl Street

## Kitchen

Width: 3.59 m  
Length: 4.84 m  
Area: 16.12 m<sup>2</sup>  
Perimeter: 16.86 m

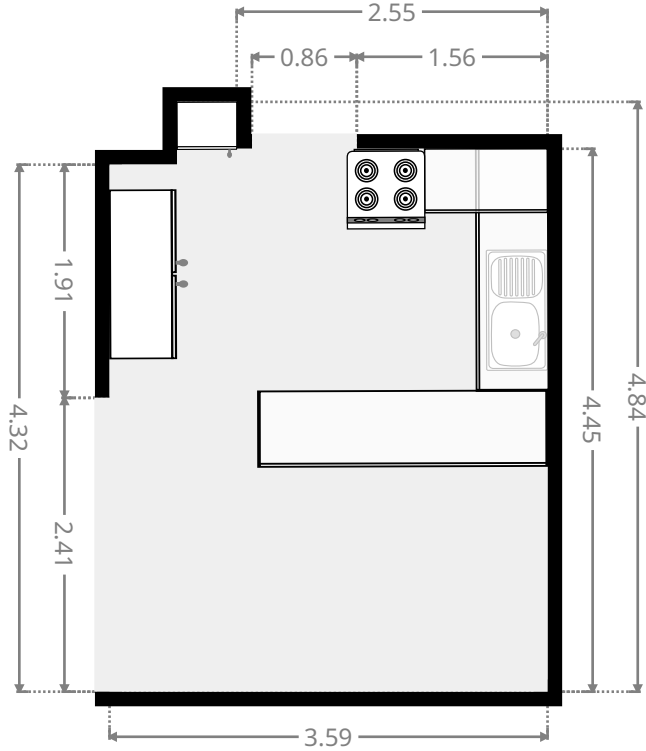
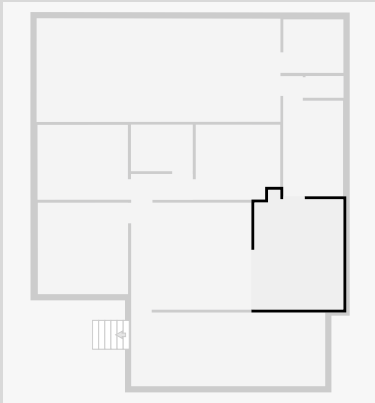

## Laundry Room

Width: 2.43 m  
Length: 4.87 m  
Area: 10.17 m<sup>2</sup>  
Perimeter: 14.58 m

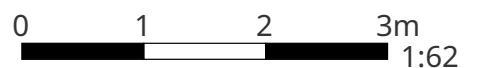
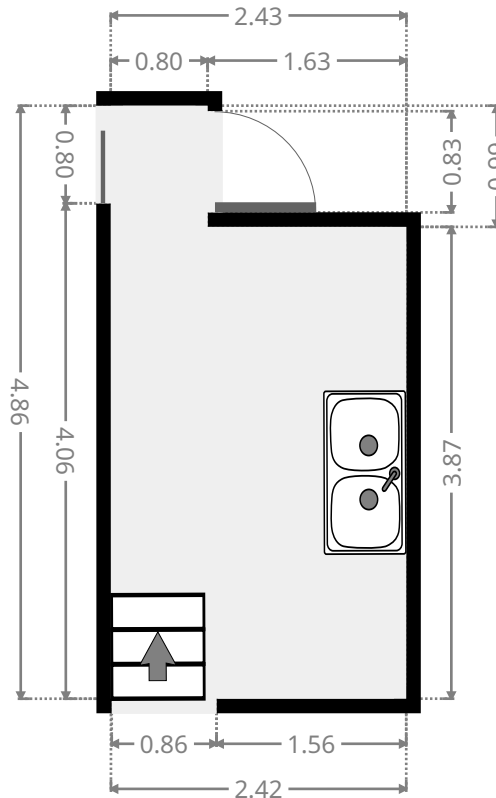
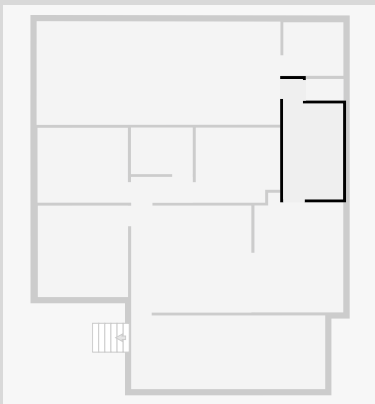

THIS FLOORPLAN IS PROVIDED WITHOUT WARRANTY OF ANY KIND. SENSOPIA DISCLAIMS ANY WARRANTY INCLUDING, WITHOUT LIMITATION, SATISFACTORY QUALITY OR ACCURACY OF DIMENSIONS.

# 209 Earl Street

## Toilet / Half Bath

Width: 0.88 m  
Length: 1.54 m  
Area: 1.35 m<sup>2</sup>  
Perimeter: 4.84 m

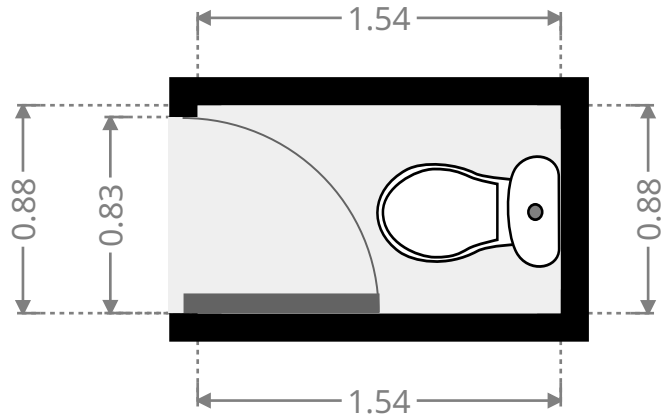
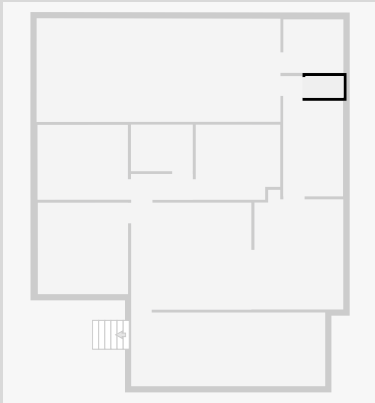

## Closet

Width: 2.16 m  
Length: 2.43 m  
Area: 5.26 m<sup>2</sup>  
Perimeter: 9.19 m

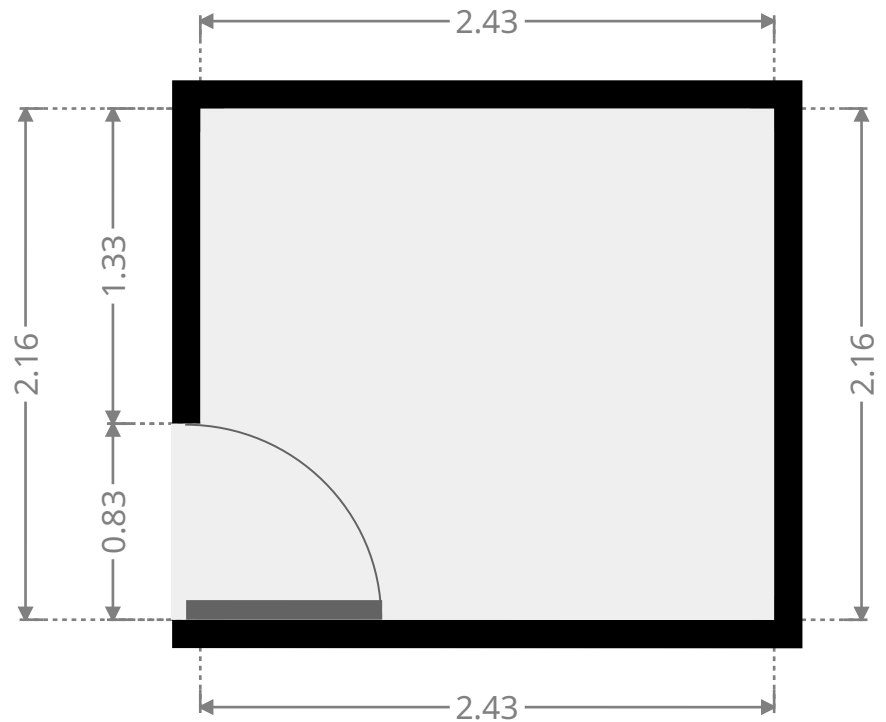
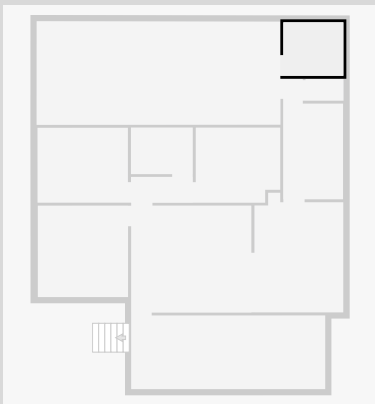

# 209 Earl Street

## Outdoor Area

Width: 4.19 m  
Length: 9.86 m  
Area: 41.25 m<sup>2</sup>  
Perimeter: 28.09 m

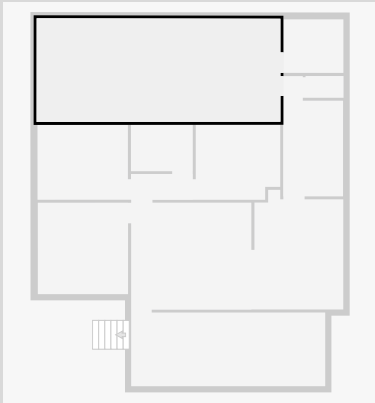

## Verandah

Width: 2.98 m  
Length: 7.85 m  
Area: 23.39 m<sup>2</sup>  
Perimeter: 21.66 m

