

205 Harrison Street

Ground Floor

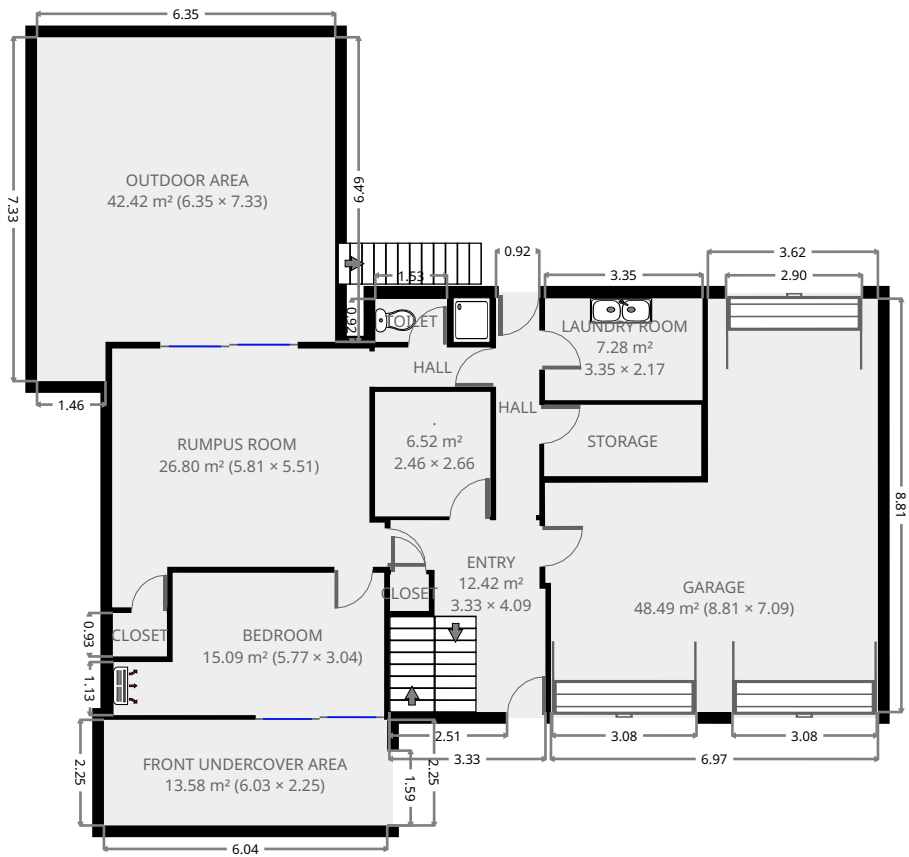

THIS FLOORPLAN IS PROVIDED WITHOUT WARRANTY OF ANY KIND. SENSOPIA DISCLAIMS ANY WARRANTY INCLUDING, WITHOUT LIMITATION, SATISFACTORY QUALITY OR ACCURACY OF DIMENSIONS.



205 Harrison Street

Bedroom

Width: 3.04 m
Length: 5.77 m
Area: 15.09 m²
Perimeter: 17.60 m

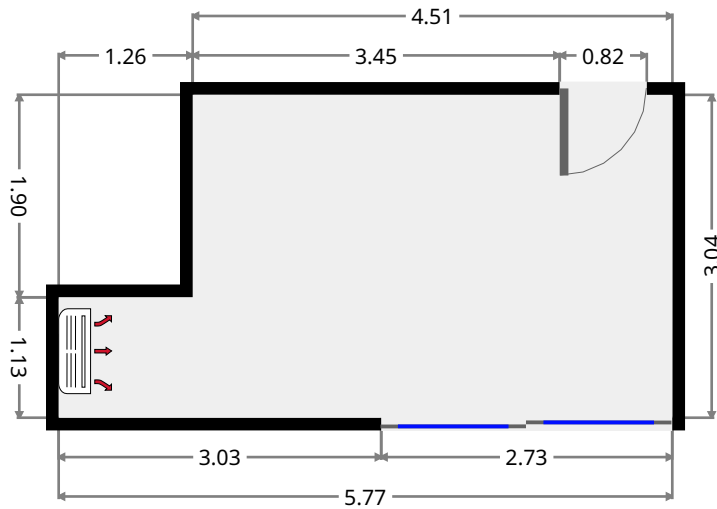
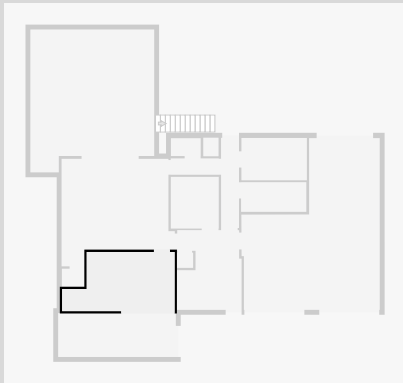

Rumpus Room

Width: 5.51 m
Length: 5.81 m
Area: 26.80 m²
Perimeter: 22.64 m

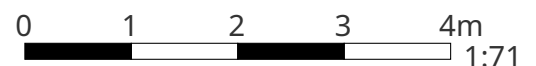
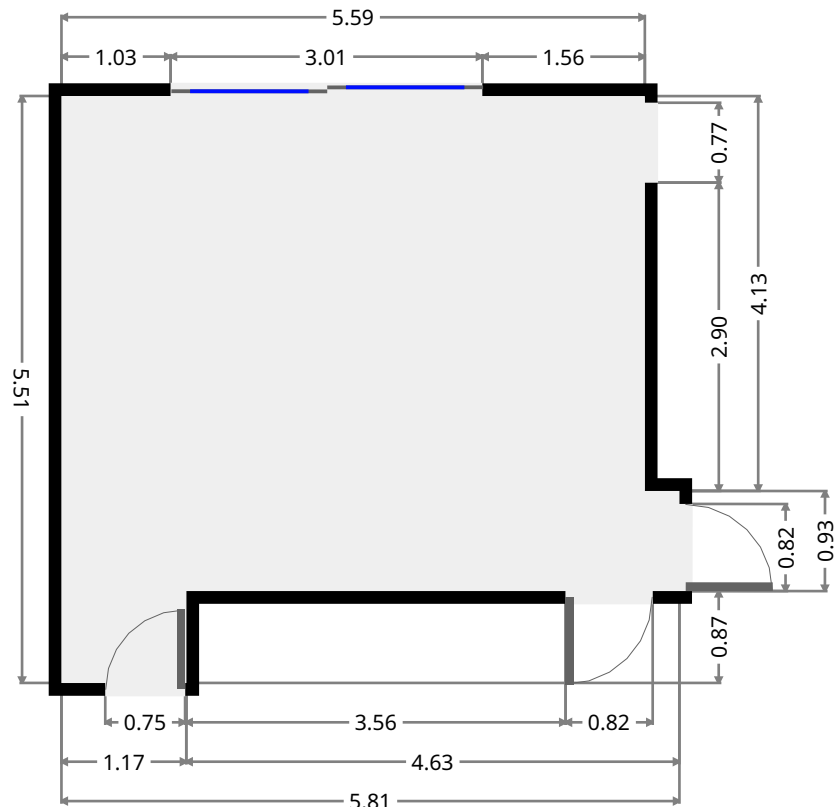
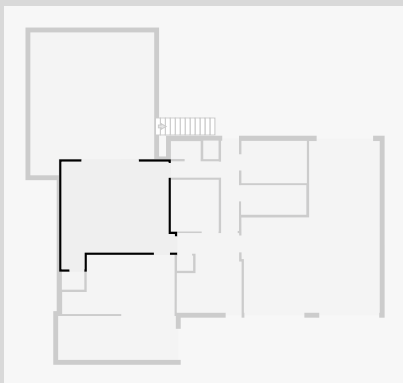

THIS FLOORPLAN IS PROVIDED WITHOUT WARRANTY OF ANY KIND. SENSOPIA DISCLAIMS ANY WARRANTY INCLUDING, WITHOUT LIMITATION, SATISFACTORY QUALITY OR ACCURACY OF DIMENSIONS.

205 Harrison Street

Closet

Width: 0.93 m
Length: 1.15 m
Area: 1.07 m²
Perimeter: 4.16 m

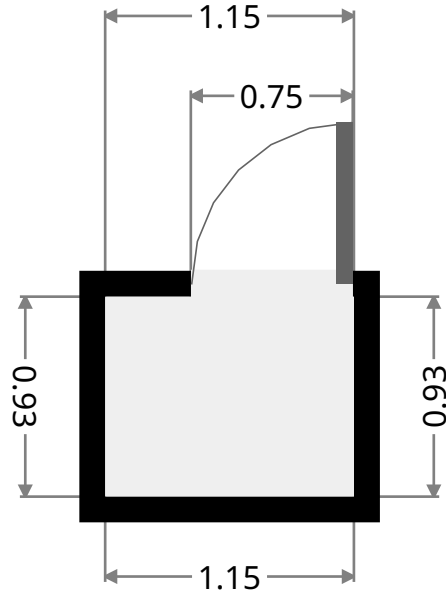
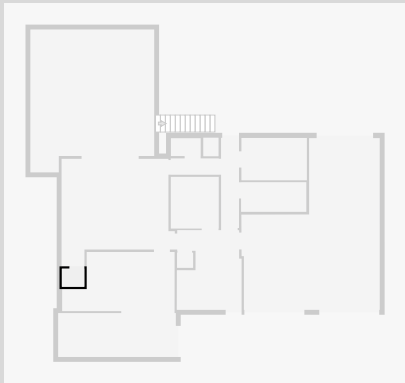

Hall

Width: 0.85 m
Length: 2.46 m
Area: 2.07 m²
Perimeter: 6.61 m

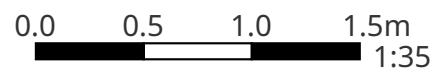
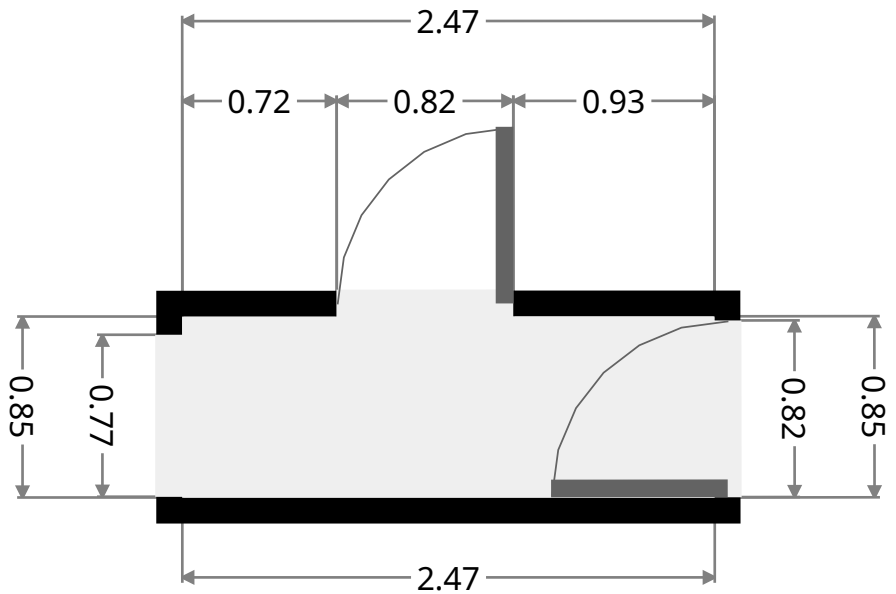
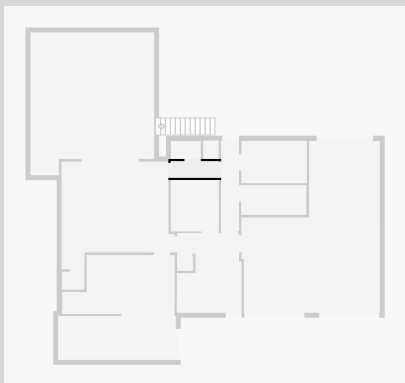

205 Harrison Street

Toilet

Width: 0.91 m
Length: 1.53 m
Area: 1.40 m²
Perimeter: 4.88 m

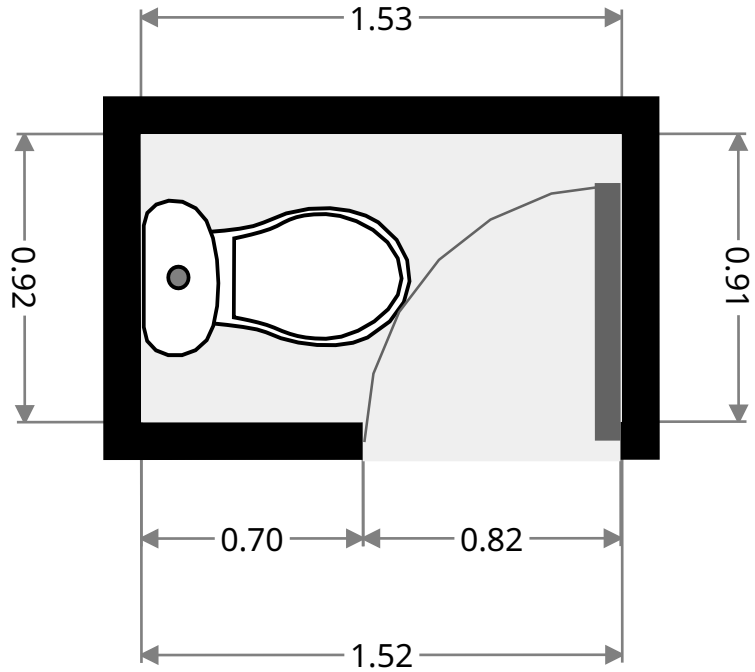

Bathroom

Width: 0.78 m
Length: 0.96 m
Area: 0.75 m²
Perimeter: 3.47 m

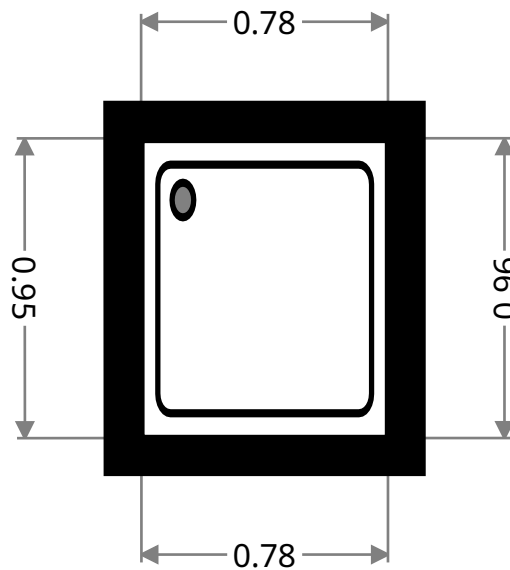

205 Harrison Street

Entry

Width: 3.33 m
 Length: 4.09 m
 Area: 12.42 m²
 Perimeter: 16.70 m

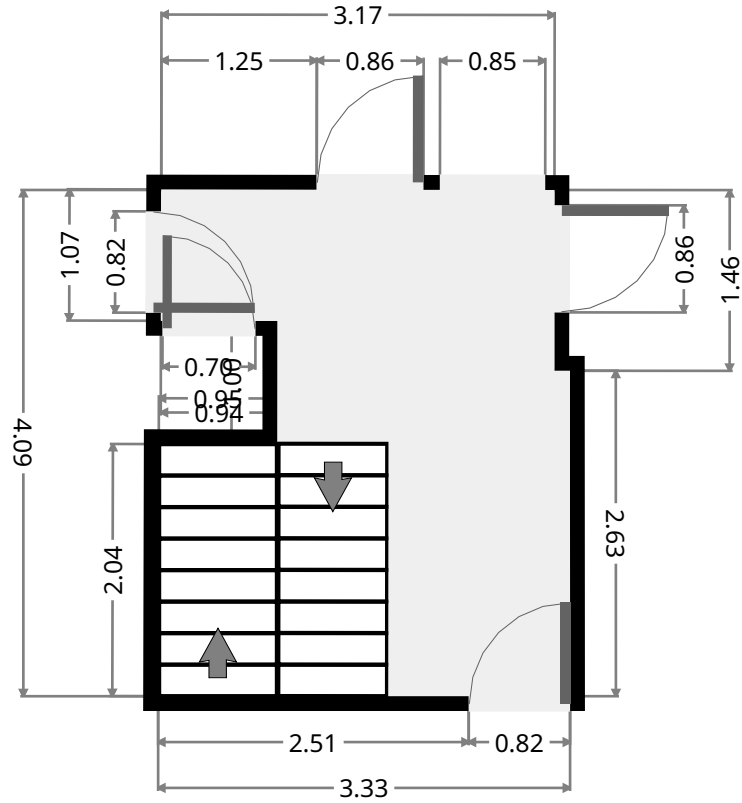
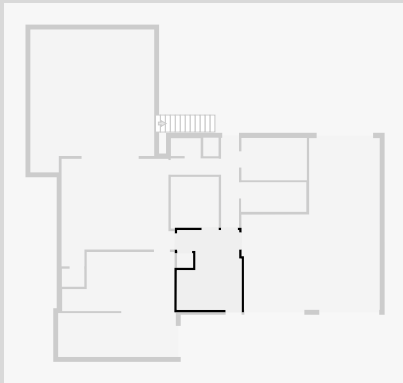

Closet

Width: 0.78 m
 Length: 0.83 m
 Area: 0.64 m²
 Perimeter: 3.21 m

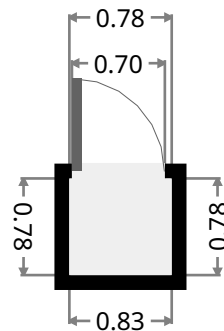
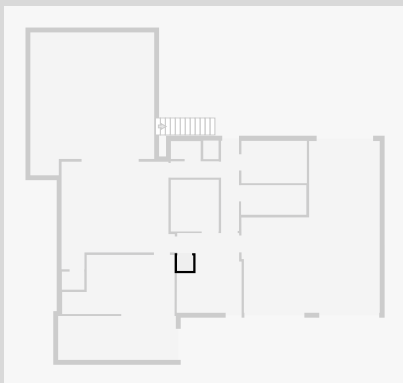

205 Harrison Street

•
 Width: 2.46 m
 Length: 2.66 m
 Area: 6.52 m²
 Perimeter: 10.22 m

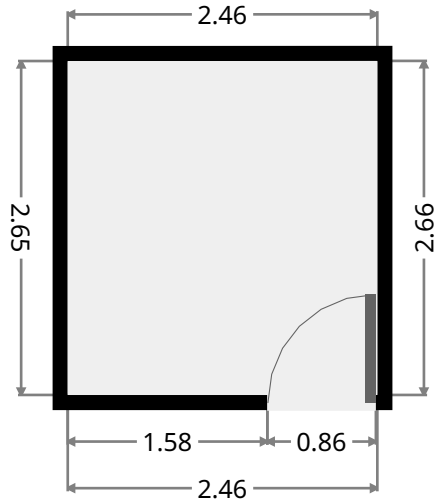
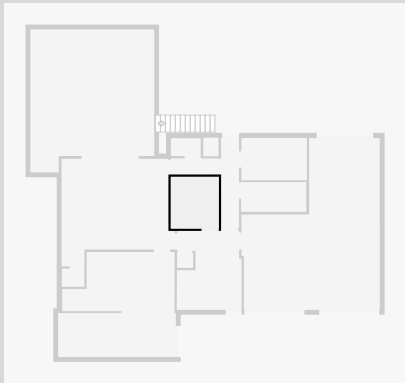

Hall

Width: 0.92 m
 Length: 4.62 m
 Area: 4.25 m²
 Perimeter: 11.09 m

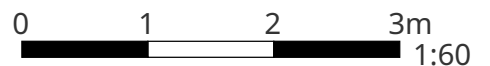
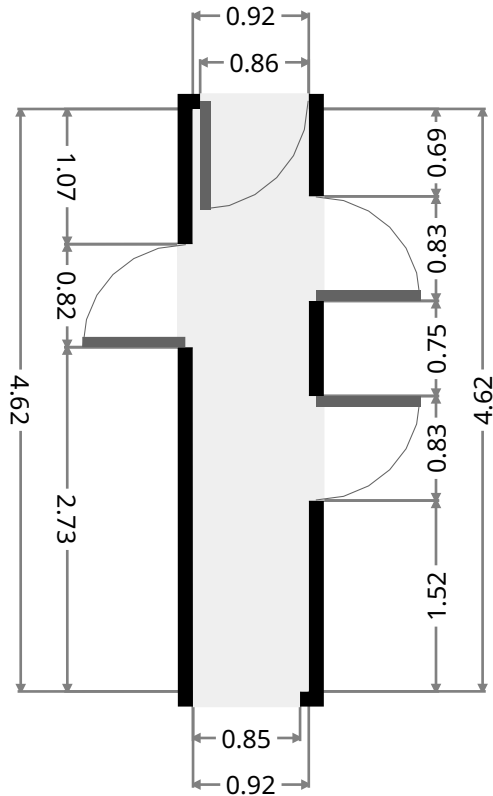
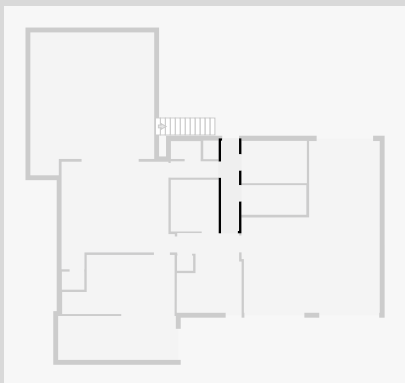

205 Harrison Street

Laundry Room

Width: 2.17 m
Length: 3.35 m
Area: 7.28 m²
Perimeter: 11.05 m

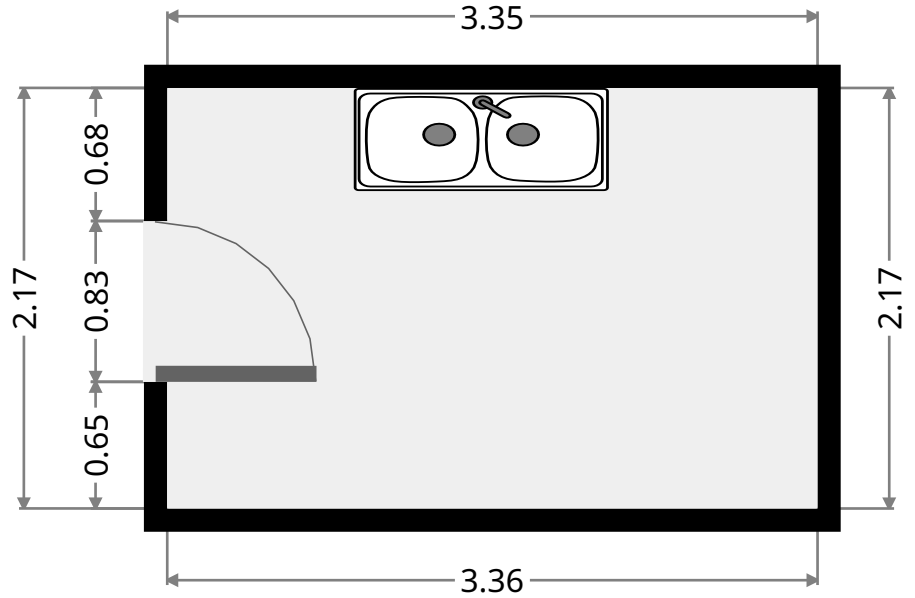
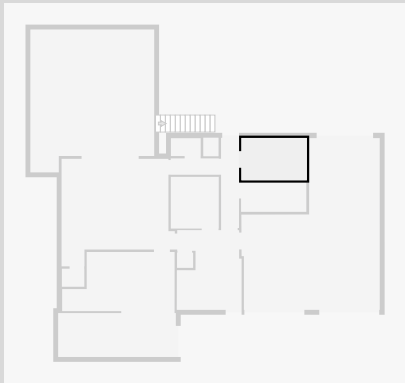

Storage

Width: 1.52 m
Length: 3.35 m
Area: 5.09 m²
Perimeter: 9.73 m

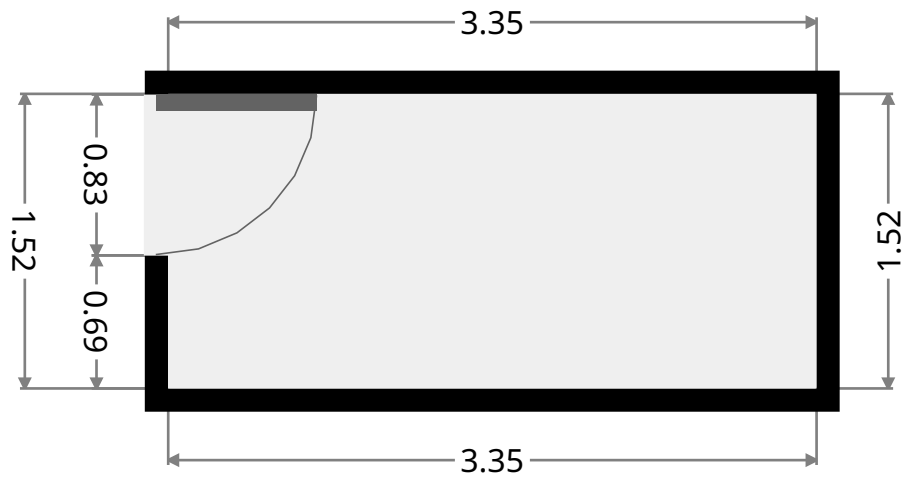
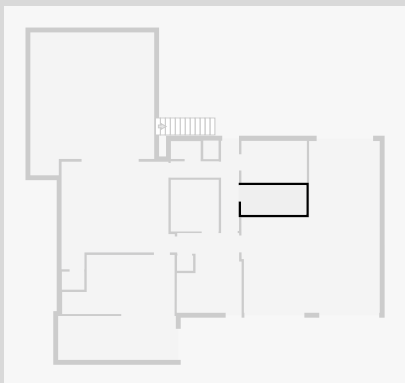

205 Harrison Street

Garage

Width: 7.09 m
 Length: 8.81 m
 Area: 48.49 m²
 Perimeter: 31.78 m

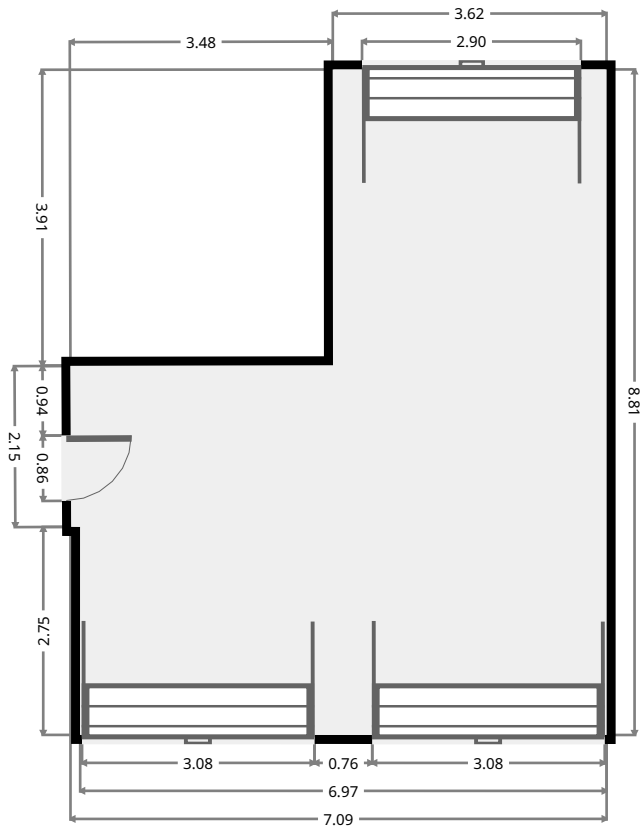
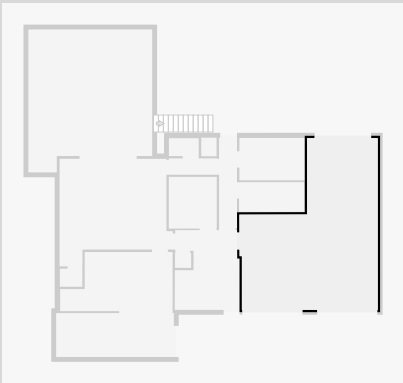

Front UnderCover Area

Width: 2.25 m
 Length: 6.03 m
 Area: 13.58 m²
 Perimeter: 16.57 m

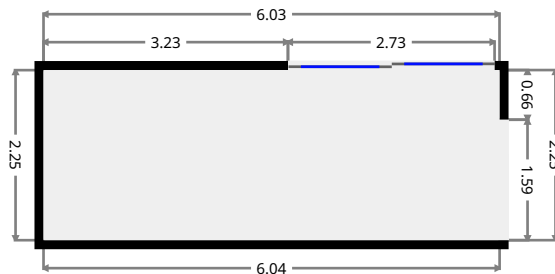
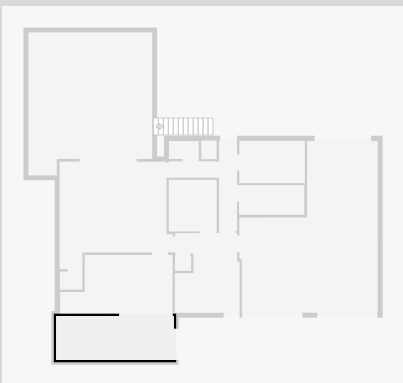

205 Harrison Street

Outdoor Area

Width: 6.35 m
Length: 7.33 m
Area: 42.42 m²
Perimeter: 27.35 m

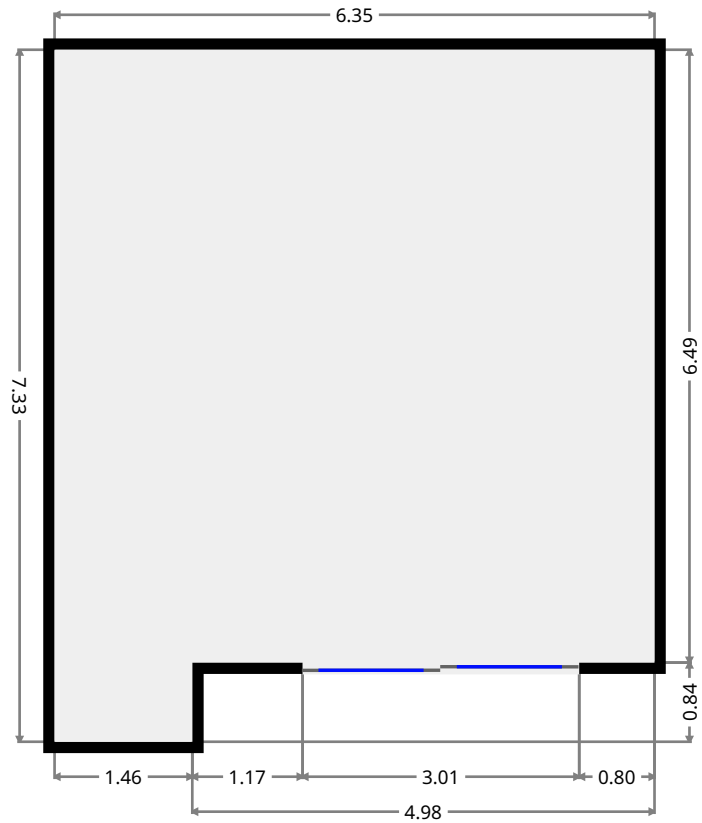
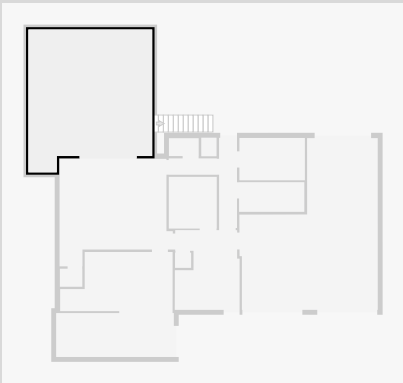

205 Harrison Street

1st Floor

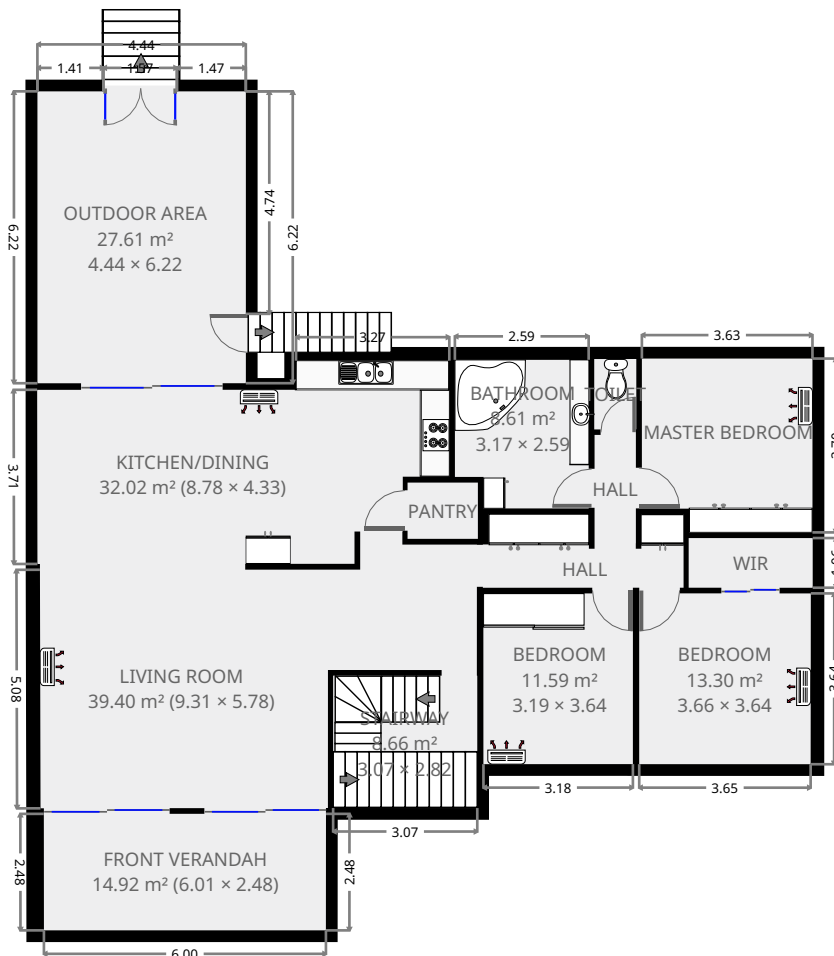
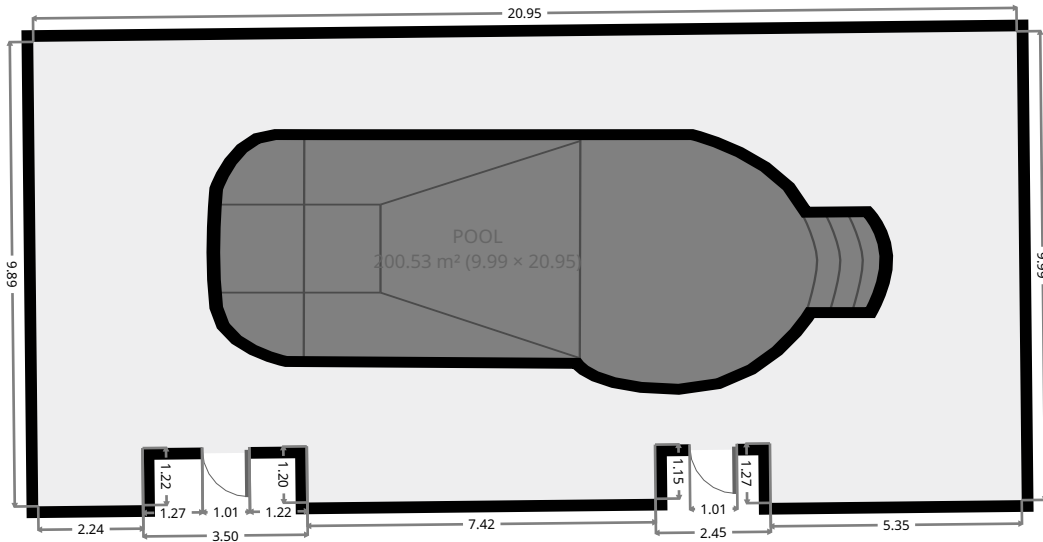

THIS FLOORPLAN IS PROVIDED WITHOUT WARRANTY OF ANY KIND. SENSOPIA DISCLAIMS ANY WARRANTY INCLUDING, WITHOUT LIMITATION, SATISFACTORY QUALITY OR ACCURACY OF DIMENSIONS.



205 Harrison Street

Living Room

Width: 5.78 m
 Length: 9.31 m
 Area: 39.40 m²
 Perimeter: 30.15 m

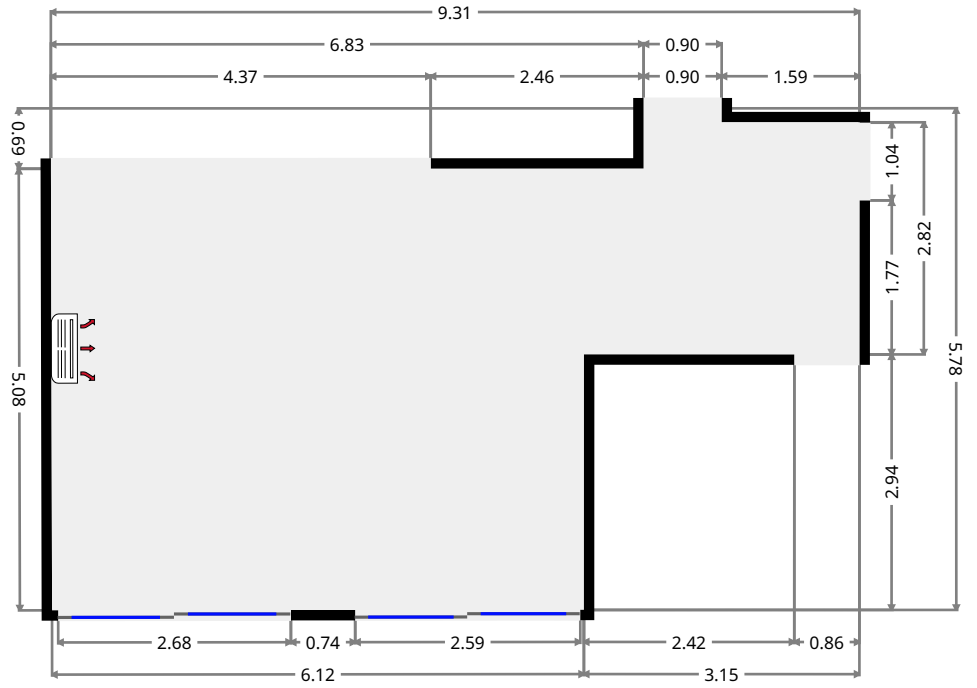
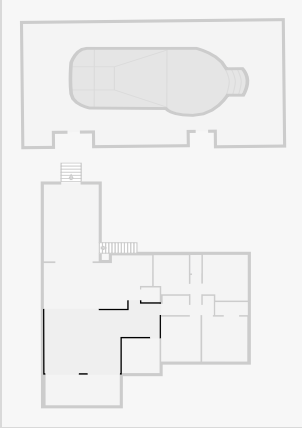

Stairway

Width: 2.82 m
 Length: 3.07 m
 Area: 8.66 m²
 Perimeter: 11.78 m

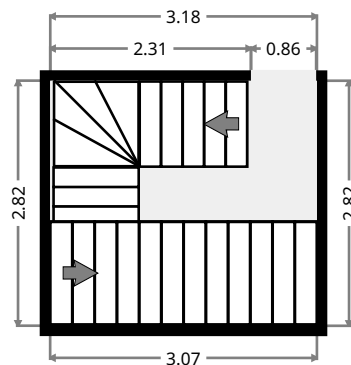
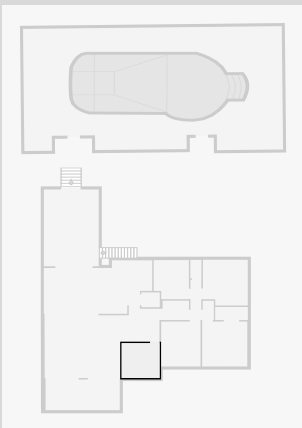

205 Harrison Street

Kitchen/Dining

Width: 4.33 m
 Length: 8.78 m
 Area: 32.02 m²
 Perimeter: 26.21 m

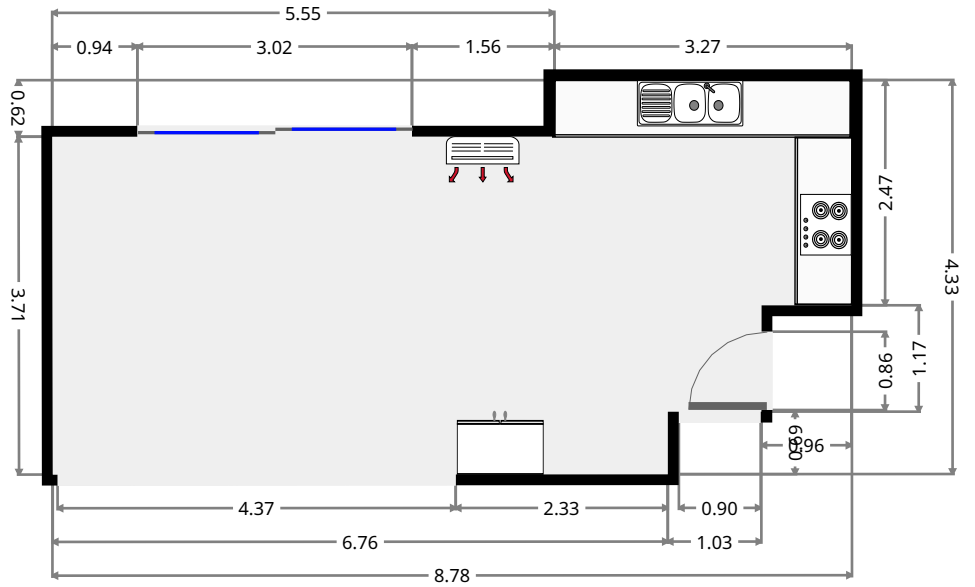
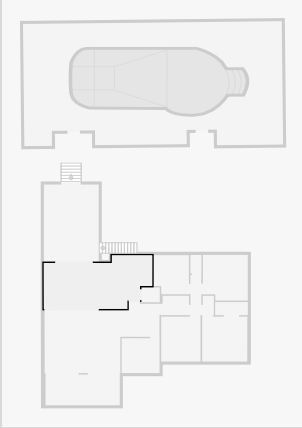

Pantry

Width: 1.20 m
 Length: 1.50 m
 Area: 1.79 m²
 Perimeter: 5.39 m

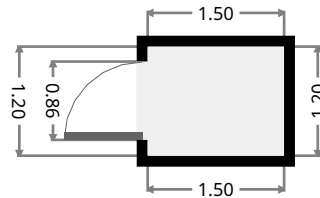
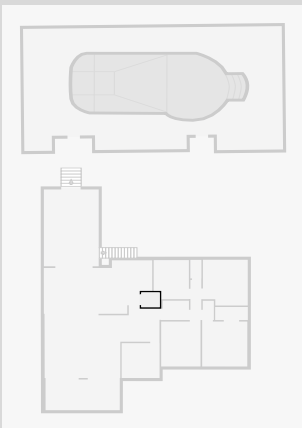

THIS FLOORPLAN IS PROVIDED WITHOUT WARRANTY OF ANY KIND. SENSOPIA DISCLAIMS ANY WARRANTY INCLUDING, WITHOUT LIMITATION, SATISFACTORY QUALITY OR ACCURACY OF DIMENSIONS.



205 Harrison Street

Hall

Width: 1.56 m
 Length: 4.28 m
 Area: 5.79 m²
 Perimeter: 13.15 m

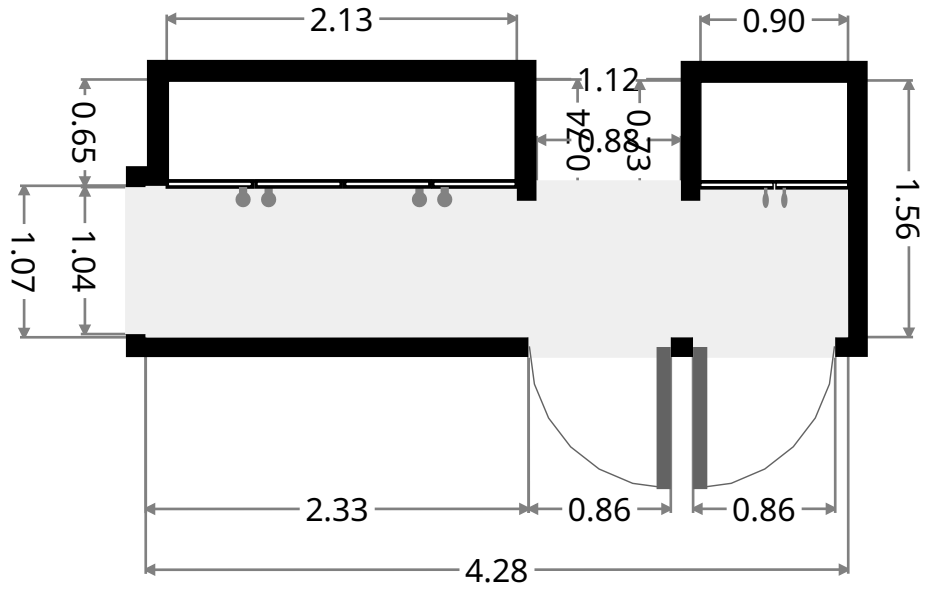
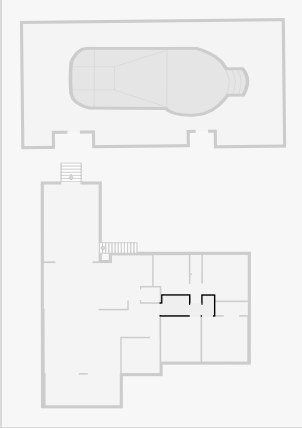

Hall

Width: 0.88 m
 Length: 2.31 m
 Area: 2.03 m²
 Perimeter: 6.38 m

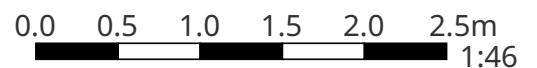
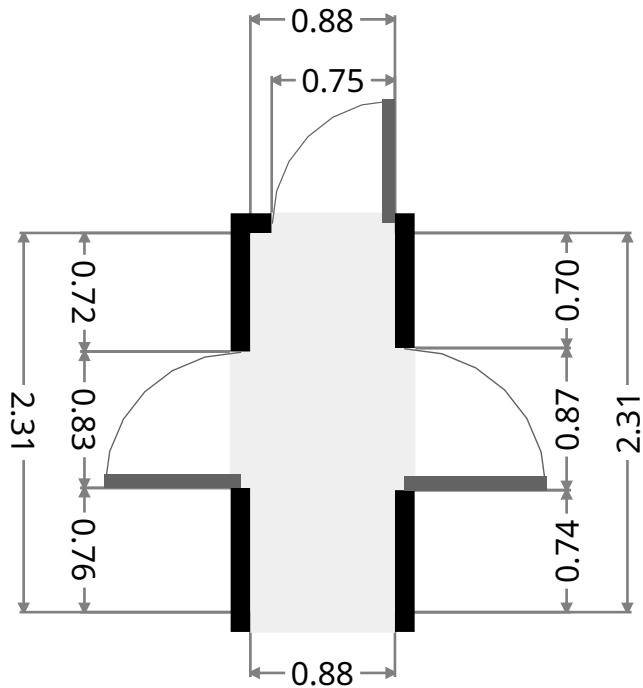
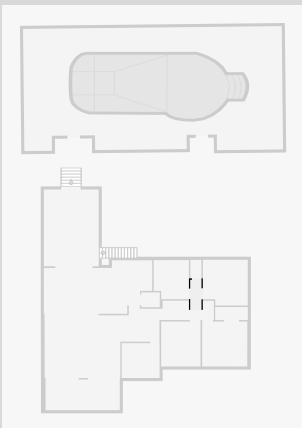

THIS FLOORPLAN IS PROVIDED WITHOUT WARRANTY OF ANY KIND. SENSOPIA DISCLAIMS ANY WARRANTY INCLUDING, WITHOUT LIMITATION, SATISFACTORY QUALITY OR ACCURACY OF DIMENSIONS.

205 Harrison Street

Bedroom

Width: 3.19 m
 Length: 3.64 m
 Area: 11.59 m²
 Perimeter: 13.65 m

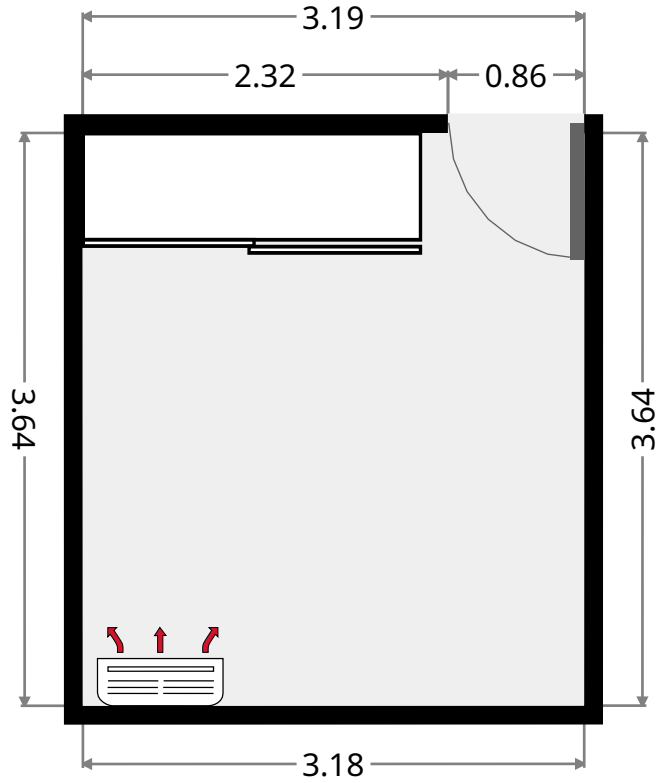
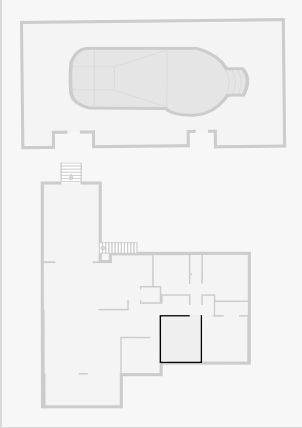

Bedroom

Width: 3.64 m
 Length: 3.66 m
 Area: 13.30 m²
 Perimeter: 14.59 m

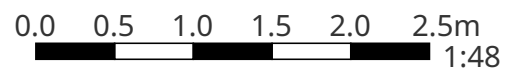
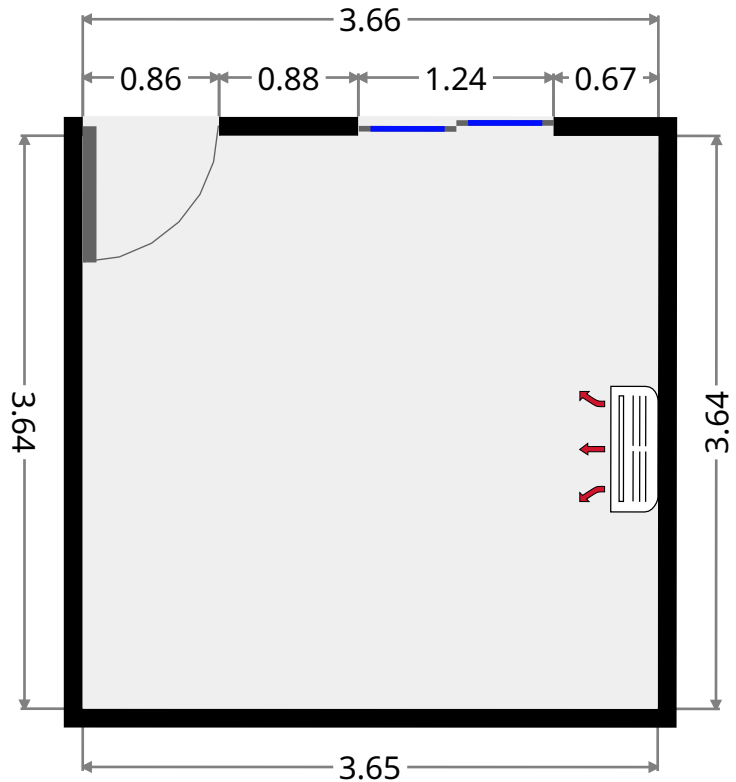
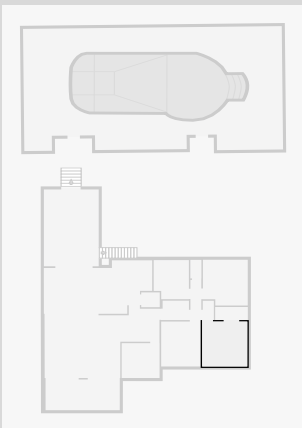

205 Harrison Street

WIR

Width: 1.06 m
 Length: 2.64 m
 Area: 2.79 m²
 Perimeter: 7.40 m

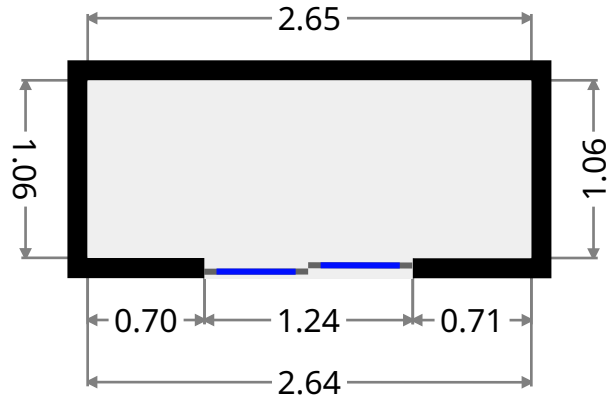
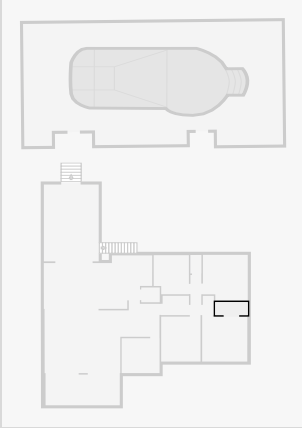

Master Bedroom

Width: 3.63 m
 Length: 3.70 m
 Area: 12.95 m²
 Perimeter: 14.67 m

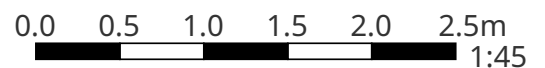
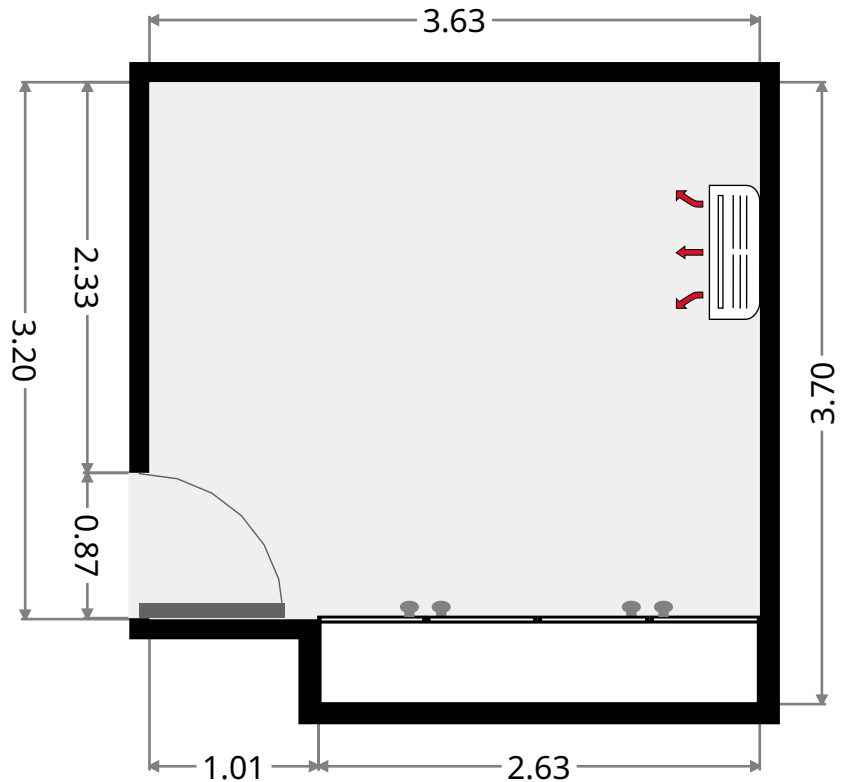
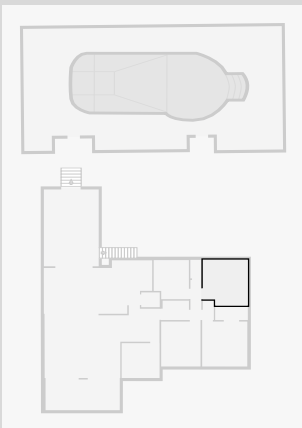

THIS FLOORPLAN IS PROVIDED WITHOUT WARRANTY OF ANY KIND. SENSOPIA DISCLAIMS ANY WARRANTY INCLUDING, WITHOUT LIMITATION, SATISFACTORY QUALITY OR ACCURACY OF DIMENSIONS.

205 Harrison Street

Toilet

Width: 0.90 m
Length: 1.50 m
Area: 1.34 m²
Perimeter: 4.79 m

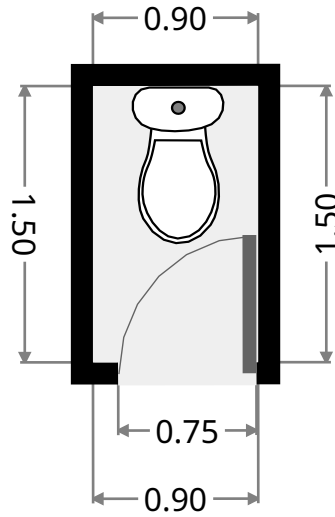
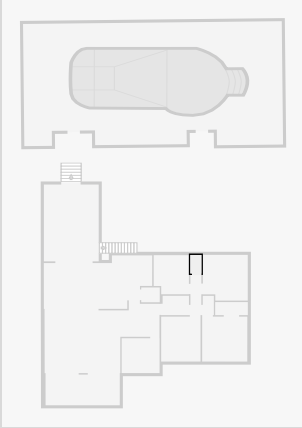

Bathroom

Width: 2.59 m
Length: 3.17 m
Area: 8.61 m²
Perimeter: 12.03 m

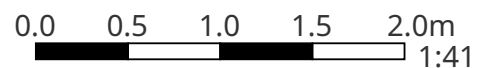
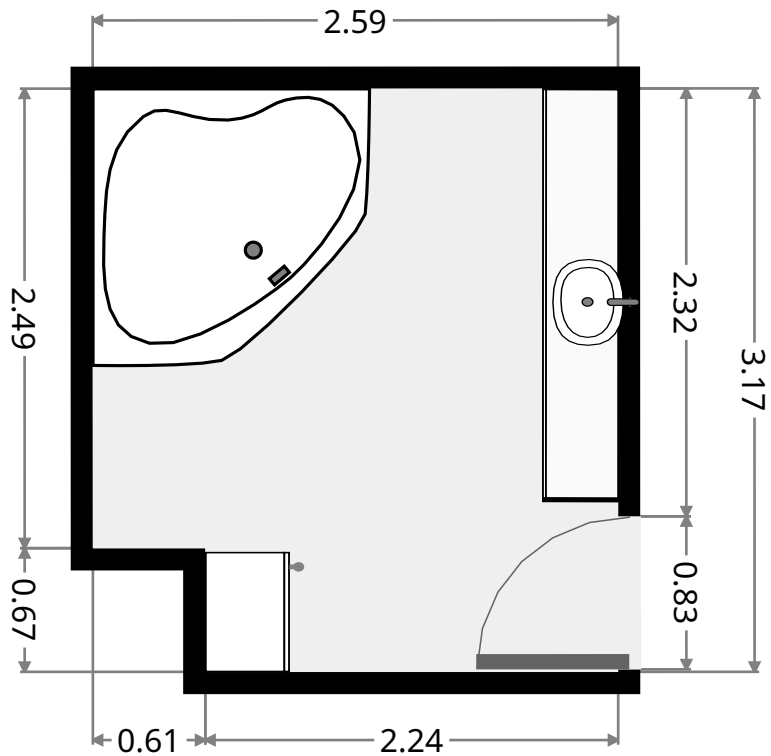
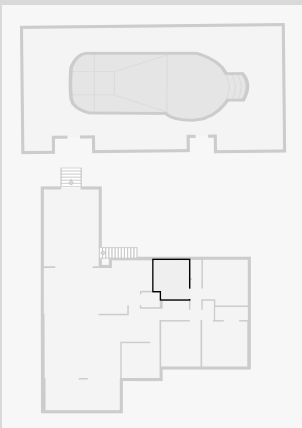

THIS FLOORPLAN IS PROVIDED WITHOUT WARRANTY OF ANY KIND. SENSOPIA DISCLAIMS ANY WARRANTY INCLUDING, WITHOUT LIMITATION, SATISFACTORY QUALITY OR ACCURACY OF DIMENSIONS.

205 Harrison Street

Outdoor Area

Width: 4.44 m
 Length: 6.22 m
 Area: 27.61 m²
 Perimeter: 21.32 m

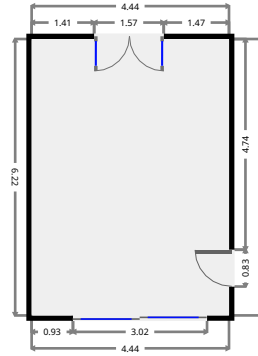
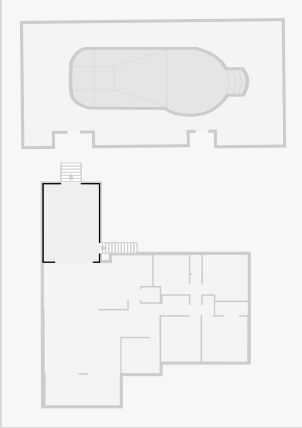

Pool

Width: 9.99 m
 Length: 20.95 m
 Area: 200.53 m²
 Perimeter: 66.62 m

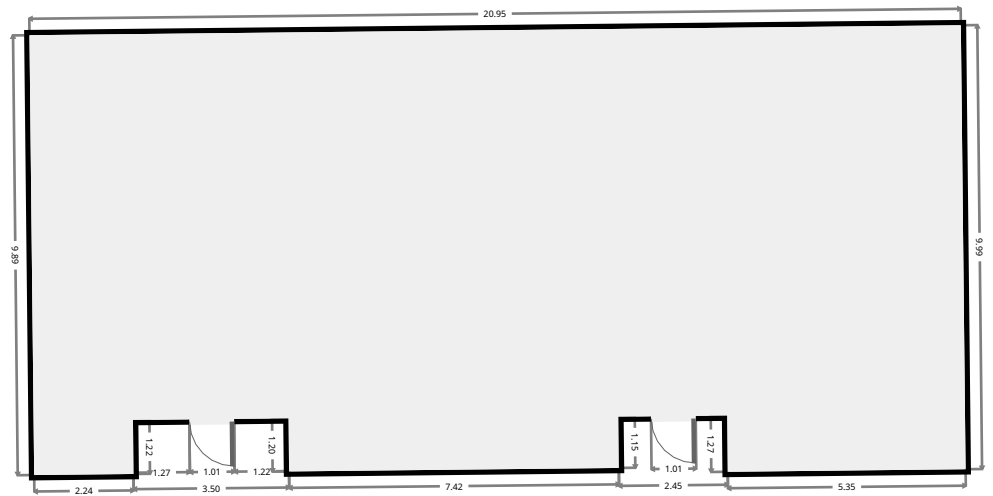
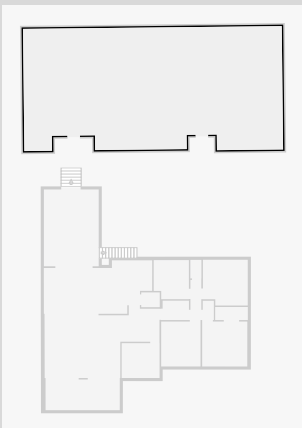

205 Harrison Street

Front Verandah

Width: 2.48 m
Length: 6.01 m
Area: 14.92 m²
Perimeter: 16.98 m

