

202 Frenchville Road

Ground Floor

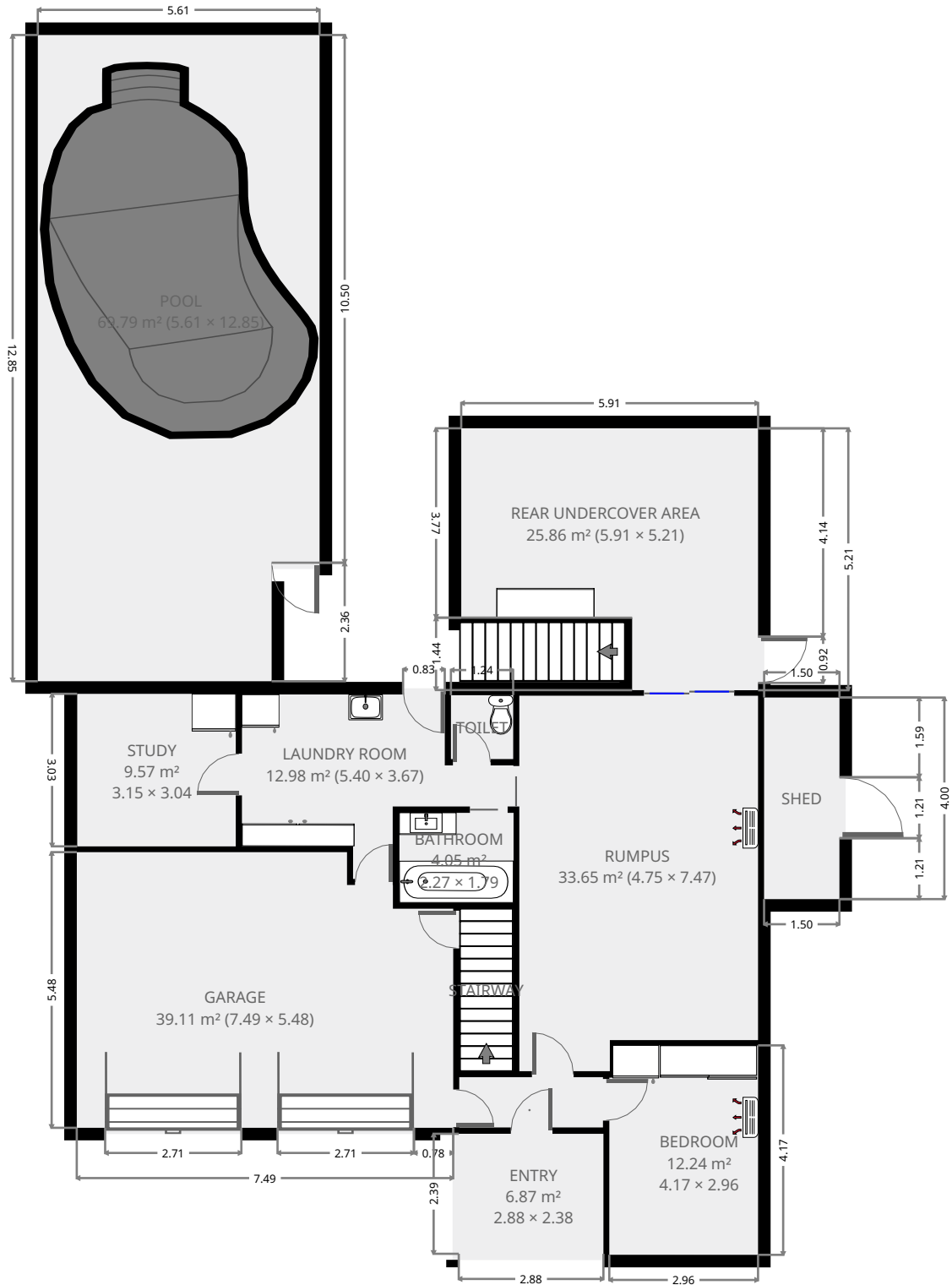

THIS FLOORPLAN IS PROVIDED WITHOUT WARRANTY OF ANY KIND. SENSOPIA DISCLAIMS ANY WARRANTY INCLUDING, WITHOUT LIMITATION, SATISFACTORY QUALITY OR ACCURACY OF DIMENSIONS.



202 Frenchville Road

Width: 1.00 m
 Length: 2.86 m
 Area: 2.86 m²
 Perimeter: 7.72 m

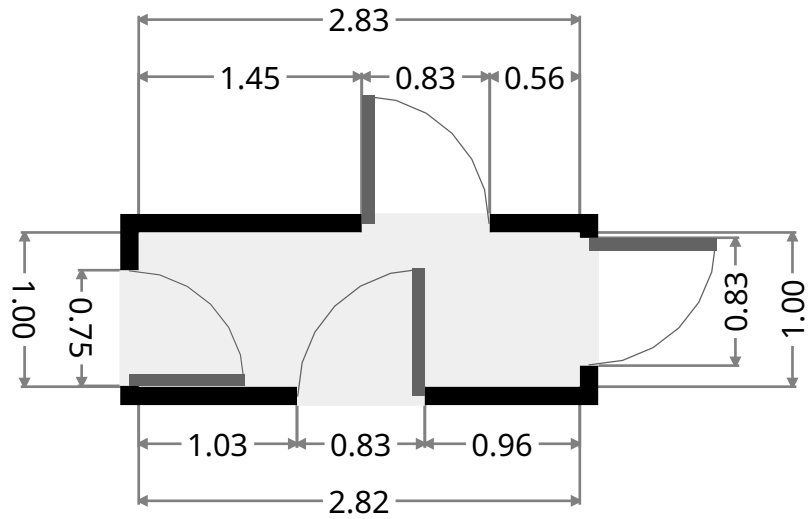
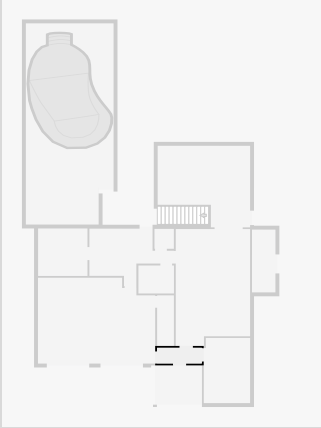

Bedroom

Width: 2.96 m
 Length: 4.17 m
 Area: 12.24 m²
 Perimeter: 14.25 m

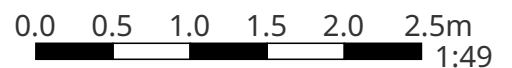
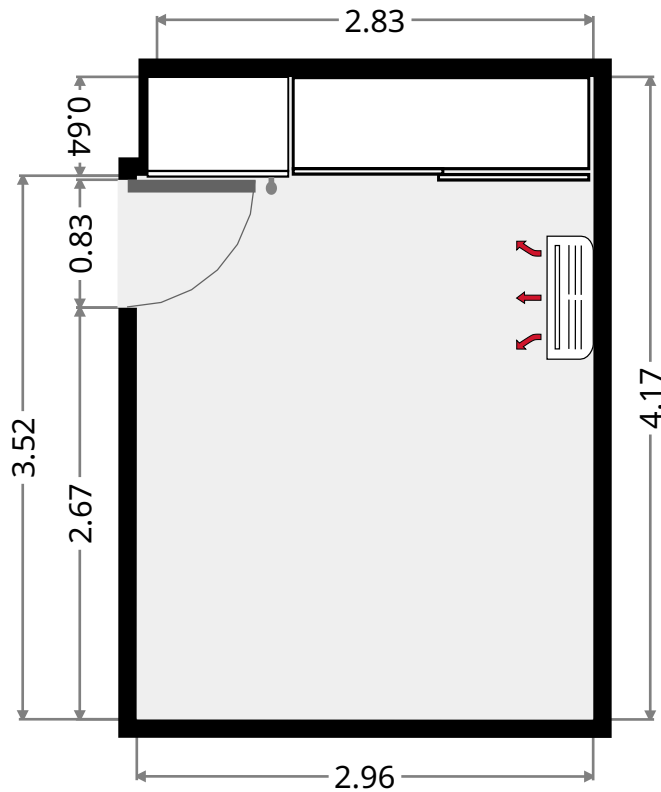
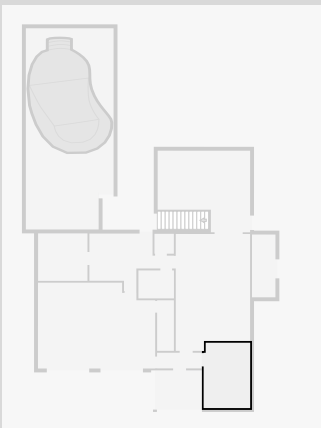

202 Frenchville Road

Rumpus

Width: 4.75 m
 Length: 7.47 m
 Area: 33.65 m²
 Perimeter: 24.43 m

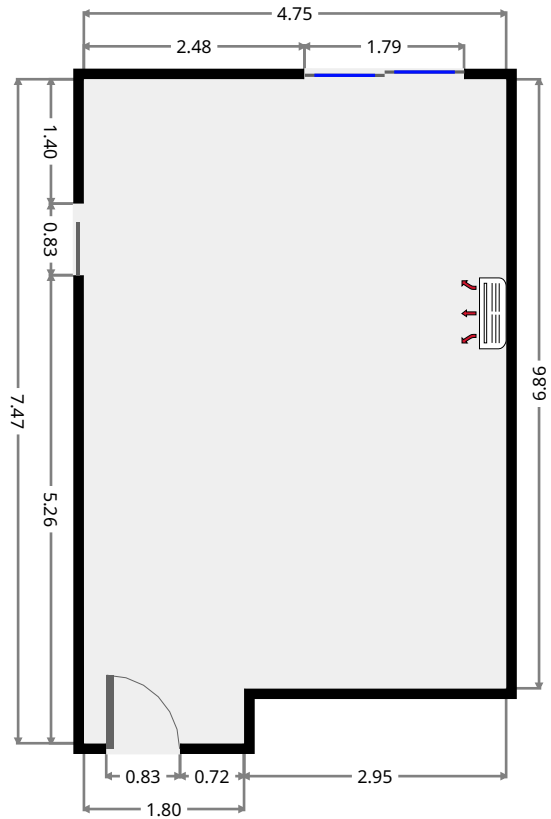
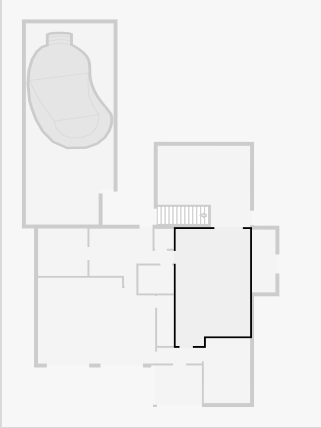

Laundry Room

Width: 3.67 m
 Length: 5.40 m
 Area: 12.98 m²
 Perimeter: 18.14 m

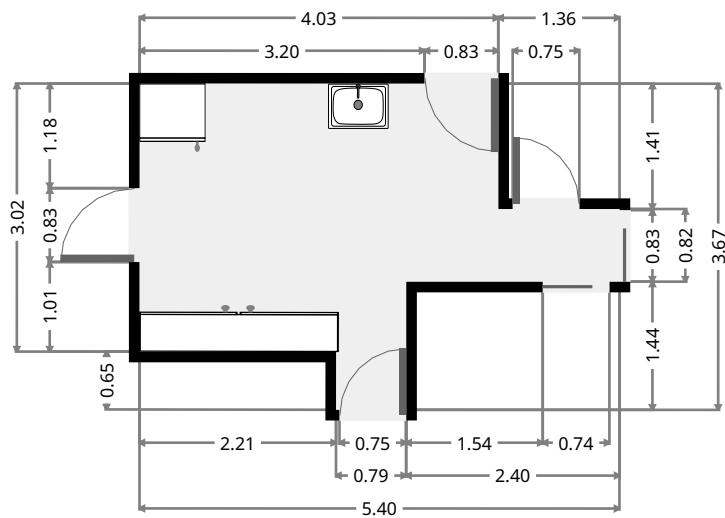
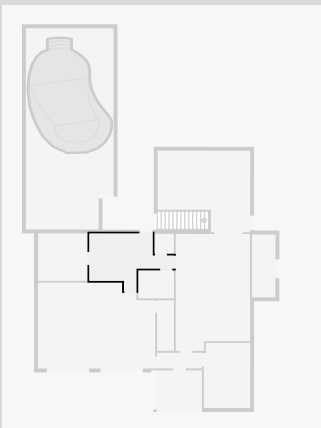

202 Frenchville Road

Bathroom

Width: 1.79 m
Length: 2.27 m
Area: 4.05 m²
Perimeter: 8.11 m

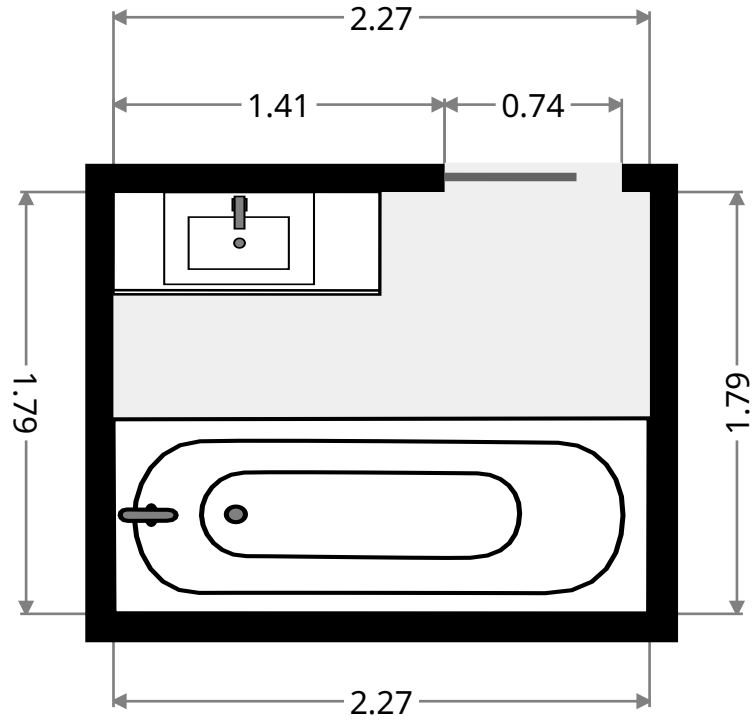
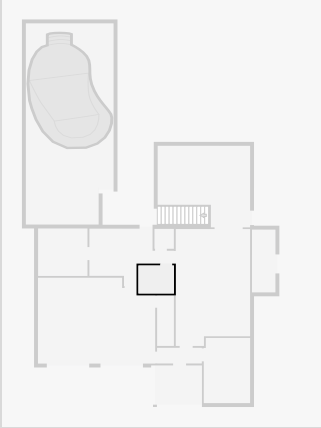

Toilet

Width: 1.24 m
Length: 1.27 m
Area: 1.57 m²
Perimeter: 5.02 m

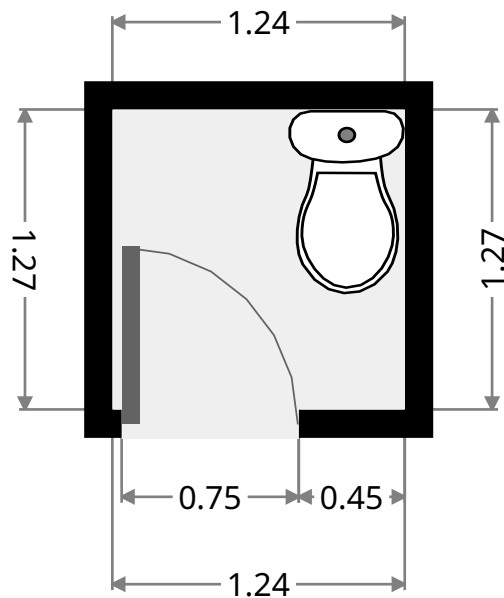
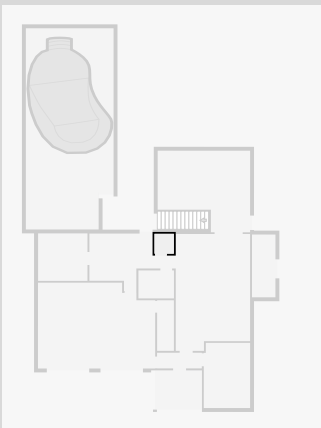

202 Frenchville Road

Study

Width: 3.04 m
 Length: 3.15 m
 Area: 9.57 m²
 Perimeter: 12.38 m

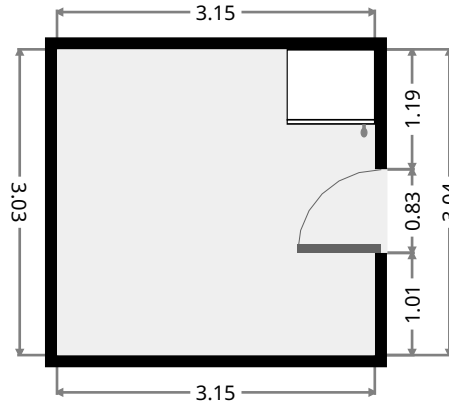
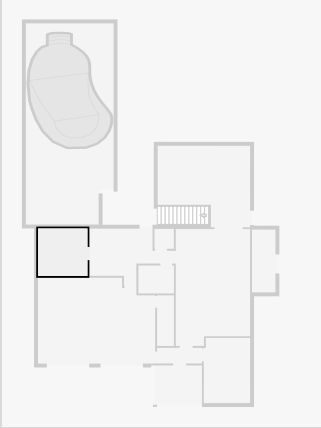

Garage

Width: 5.48 m
 Length: 7.49 m
 Area: 39.11 m²
 Perimeter: 25.94 m

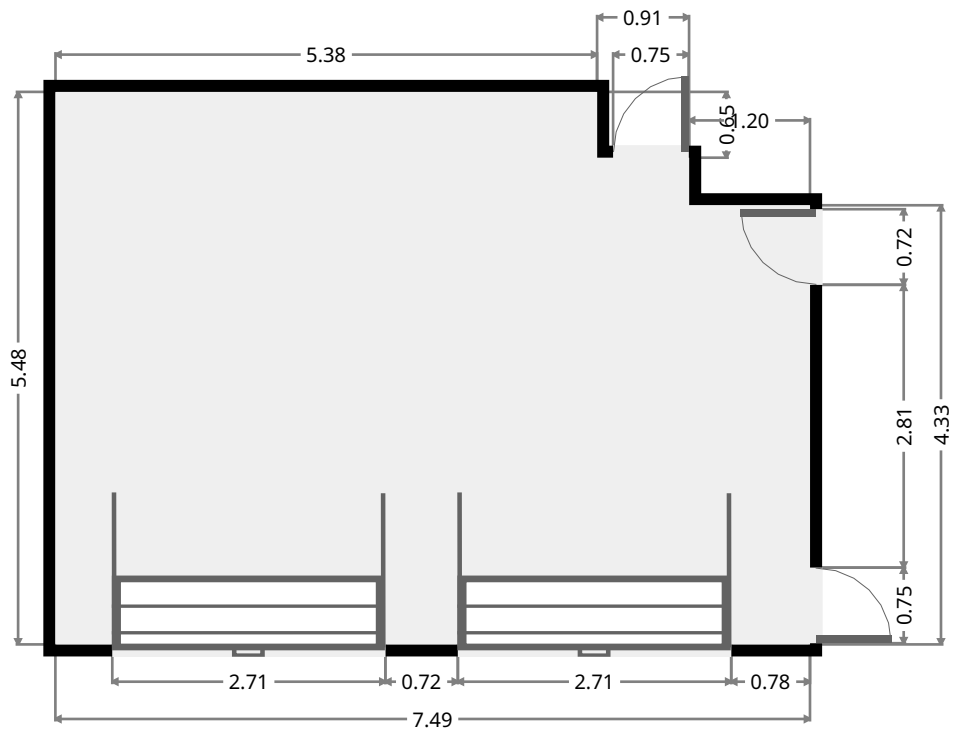
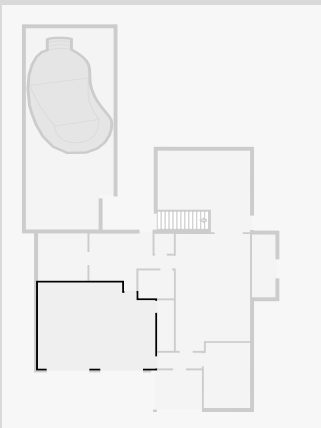

THIS FLOORPLAN IS PROVIDED WITHOUT WARRANTY OF ANY KIND. SENSOPIA DISCLAIMS ANY WARRANTY INCLUDING, WITHOUT LIMITATION, SATISFACTORY QUALITY OR ACCURACY OF DIMENSIONS.

202 Frenchville Road

Stairway

Width: 1.07 m
 Length: 3.23 m
 Area: 3.46 m²
 Perimeter: 8.60 m

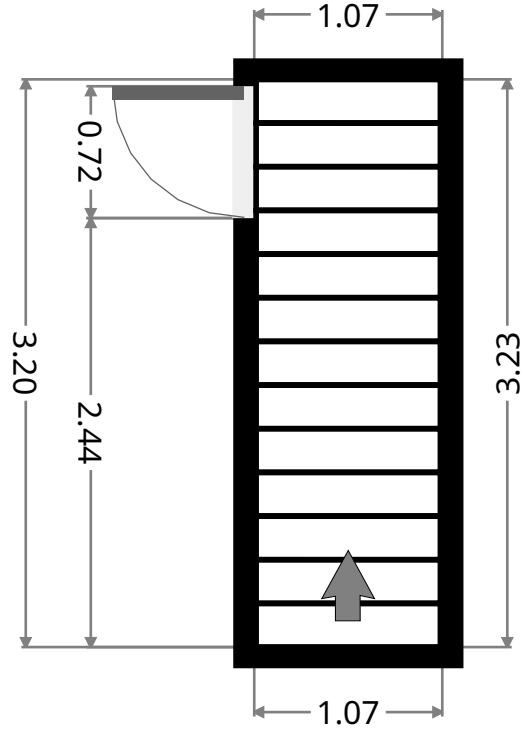
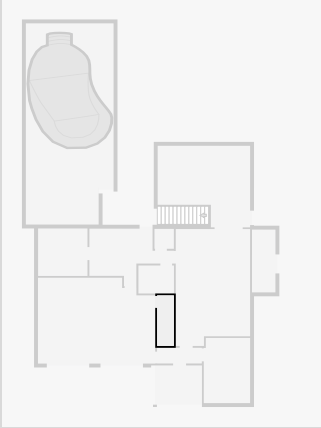

Entry

Width: 2.38 m
 Length: 2.88 m
 Area: 6.87 m²
 Perimeter: 10.53 m

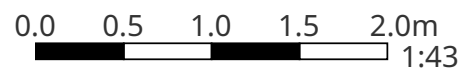
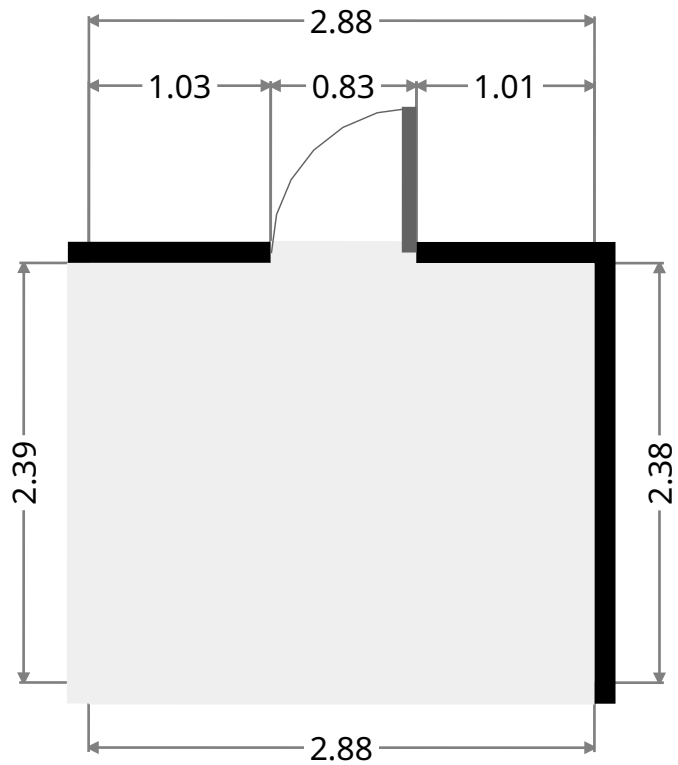
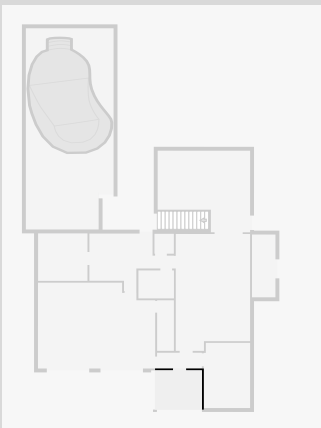

THIS FLOORPLAN IS PROVIDED WITHOUT WARRANTY OF ANY KIND. SENSOPIA DISCLAIMS ANY WARRANTY INCLUDING, WITHOUT LIMITATION, SATISFACTORY QUALITY OR ACCURACY OF DIMENSIONS.

202 Frenchville Road

Rear UnderCover Area

Width: 5.21 m
Length: 5.91 m
Area: 25.86 m²
Perimeter: 22.23 m

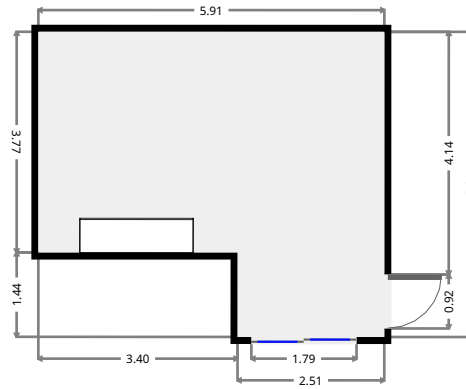
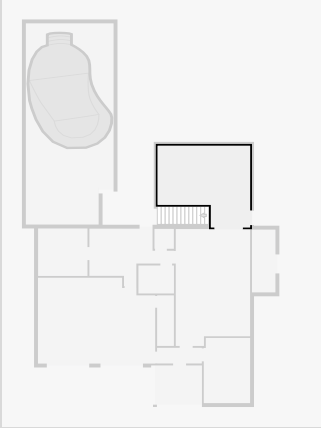

Pool

Width: 5.61 m
Length: 12.85 m
Area: 69.79 m²
Perimeter: 36.92 m

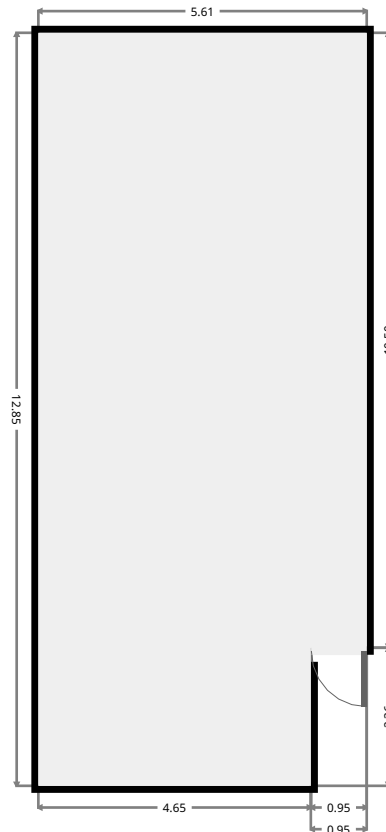
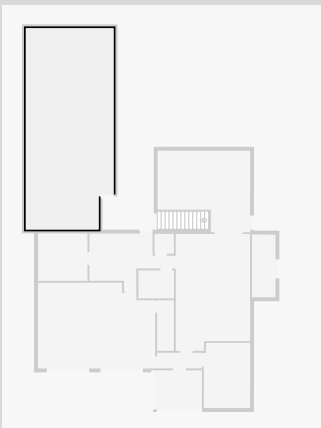

202 Frenchville Road

Shed

Width: 1.50 m
Length: 4.00 m
Area: 6.01 m²
Perimeter: 11.02 m

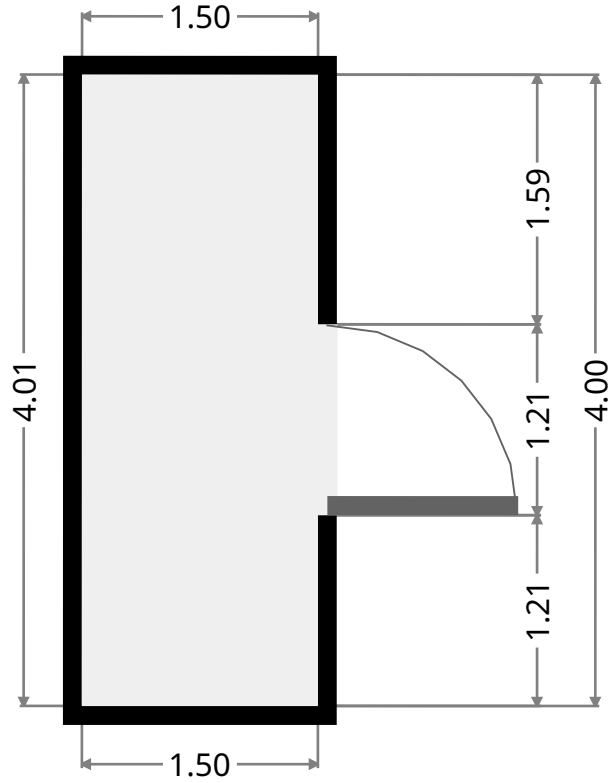
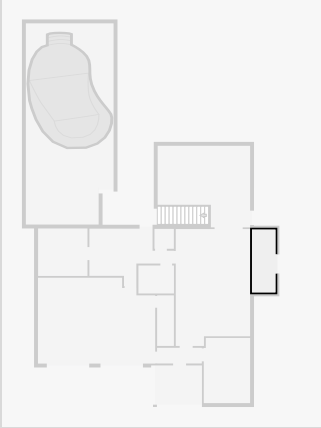

202 Frenchville Road

1st Floor

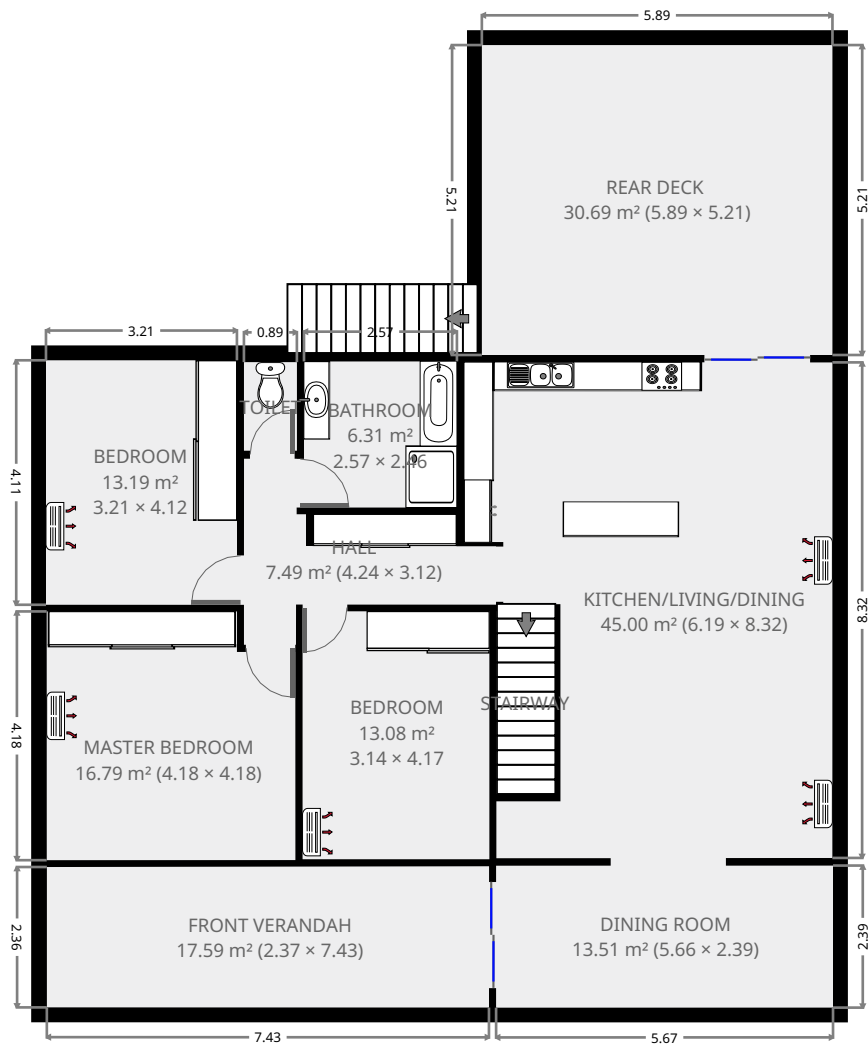

THIS FLOORPLAN IS PROVIDED WITHOUT WARRANTY OF ANY KIND. SENSOPIA DISCLAIMS ANY WARRANTY INCLUDING, WITHOUT LIMITATION, SATISFACTORY QUALITY OR ACCURACY OF DIMENSIONS.



202 Frenchville Road

Kitchen/Living/Dining

Width: 6.19 m
 Length: 8.32 m
 Area: 45.00 m²
 Perimeter: 31.19 m

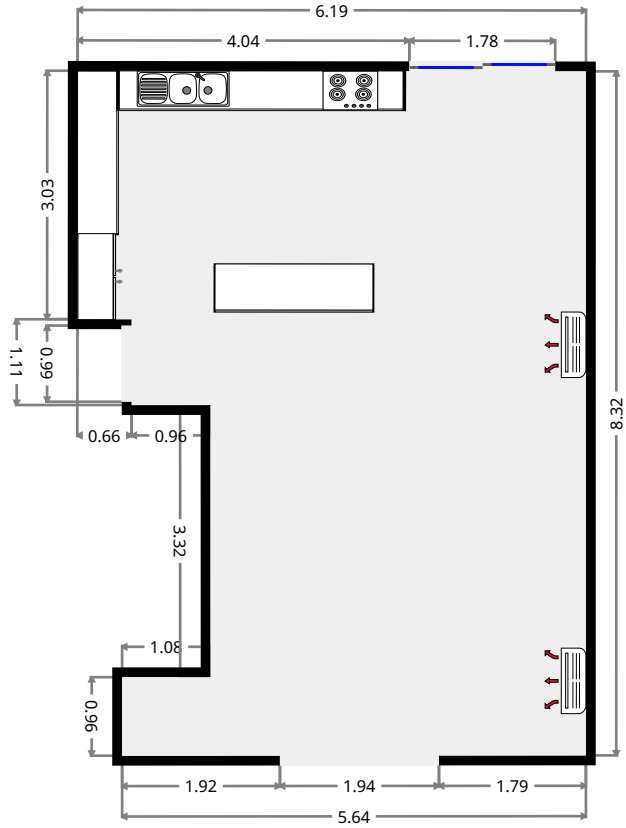
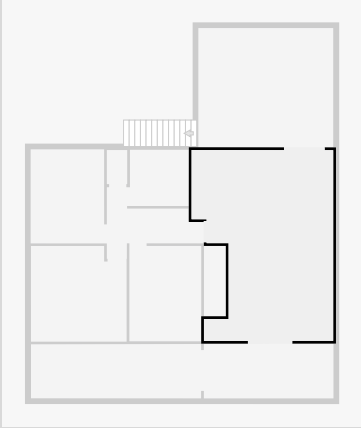

Stairway

Width: 0.96 m
 Length: 3.07 m
 Area: 2.95 m²
 Perimeter: 8.06 m

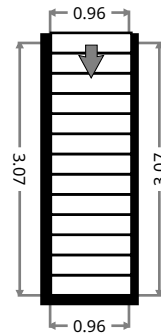
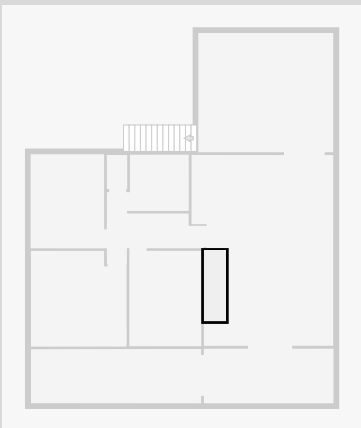

THIS FLOORPLAN IS PROVIDED WITHOUT WARRANTY OF ANY KIND. SENSOPIA DISCLAIMS ANY WARRANTY INCLUDING, WITHOUT LIMITATION, SATISFACTORY QUALITY OR ACCURACY OF DIMENSIONS.



202 Frenchville Road

Hall

Width: 3.12 m
 Length: 4.24 m
 Area: 7.49 m²
 Perimeter: 14.73 m

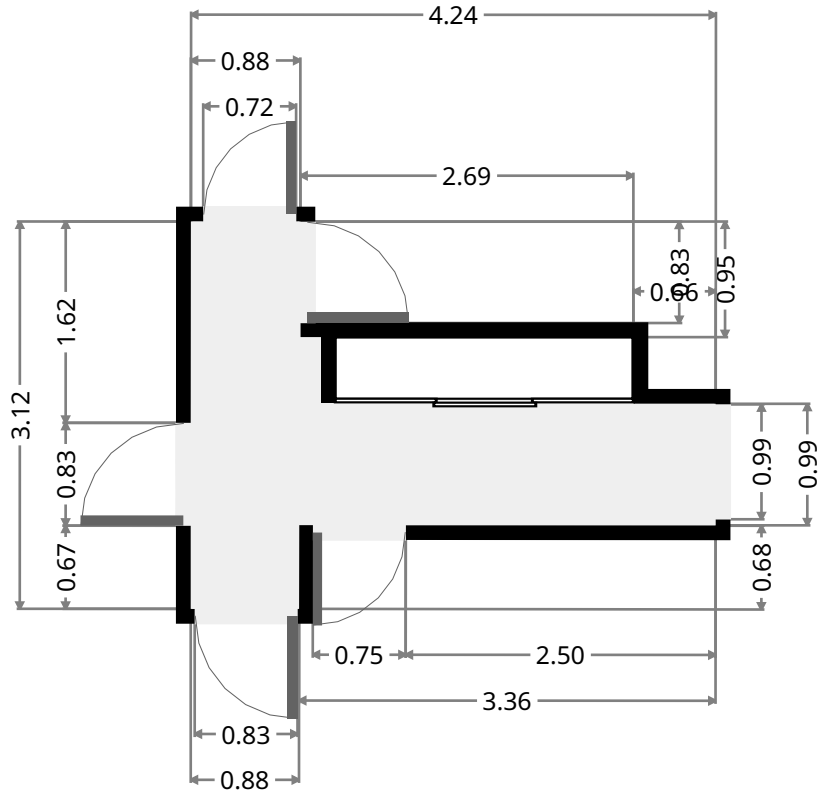
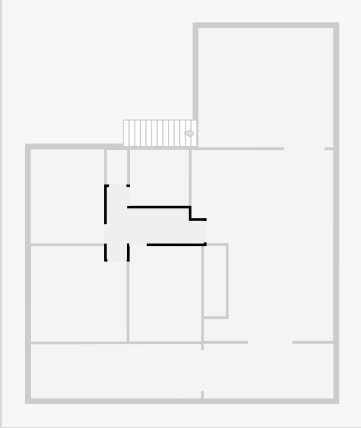

Bathroom

Width: 2.46 m
 Length: 2.57 m
 Area: 6.31 m²
 Perimeter: 10.05 m

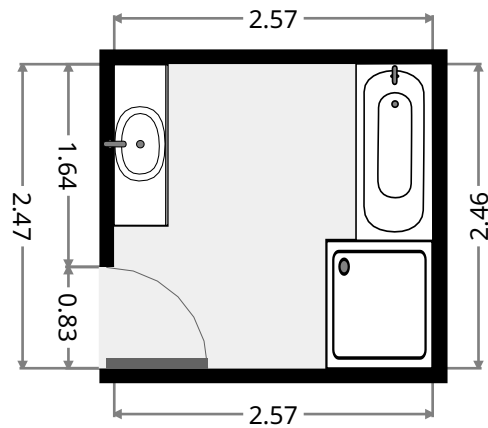
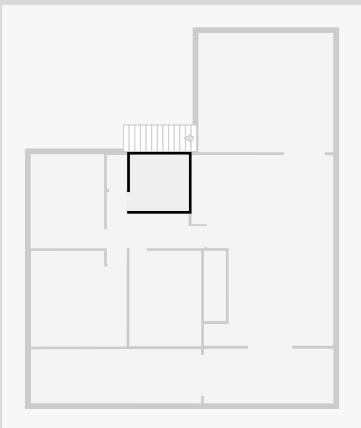

202 Frenchville Road

Toilet

Width: 0.89 m
Length: 1.48 m
Area: 1.32 m²
Perimeter: 4.76 m

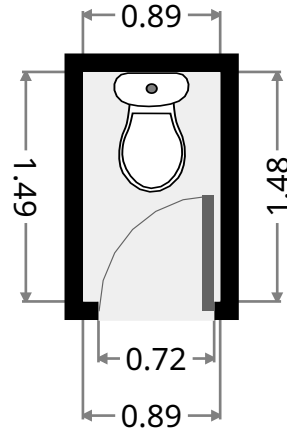
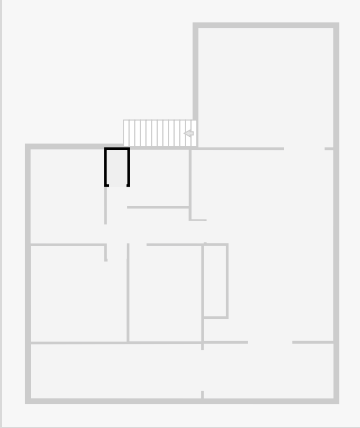

Bedroom

Width: 3.21 m
Length: 4.12 m
Area: 13.19 m²
Perimeter: 14.64 m

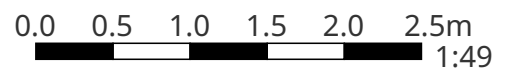
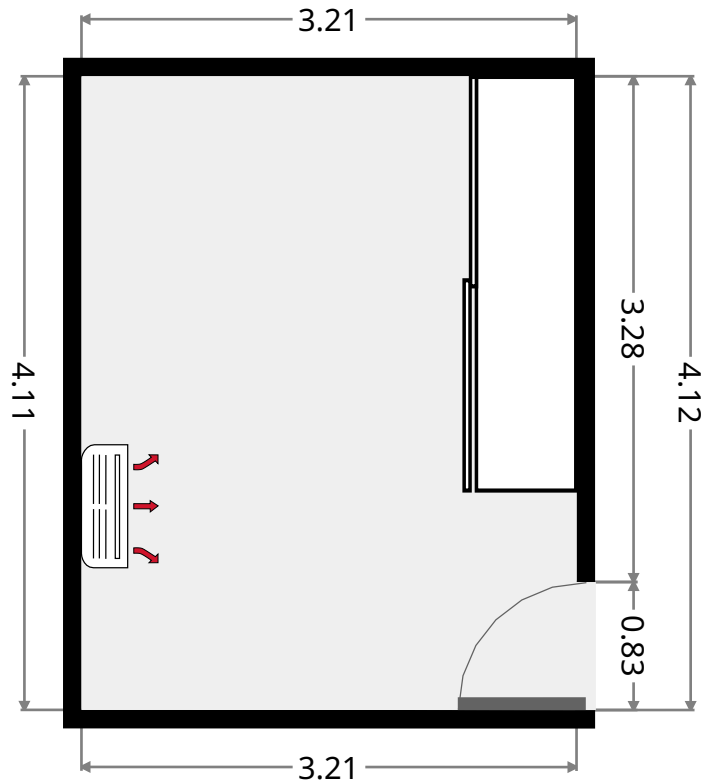
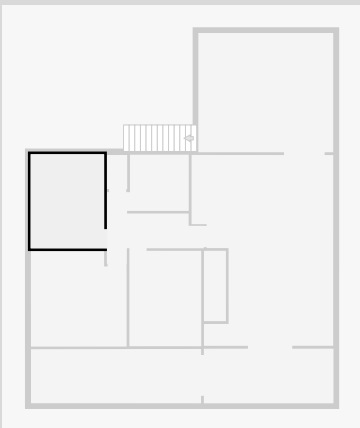

THIS FLOORPLAN IS PROVIDED WITHOUT WARRANTY OF ANY KIND. SENSOPIA DISCLAIMS ANY WARRANTY INCLUDING, WITHOUT LIMITATION, SATISFACTORY QUALITY OR ACCURACY OF DIMENSIONS.

202 Frenchville Road

Master Bedroom

Width: 4.18 m
 Length: 4.18 m
 Area: 16.79 m²
 Perimeter: 16.71 m

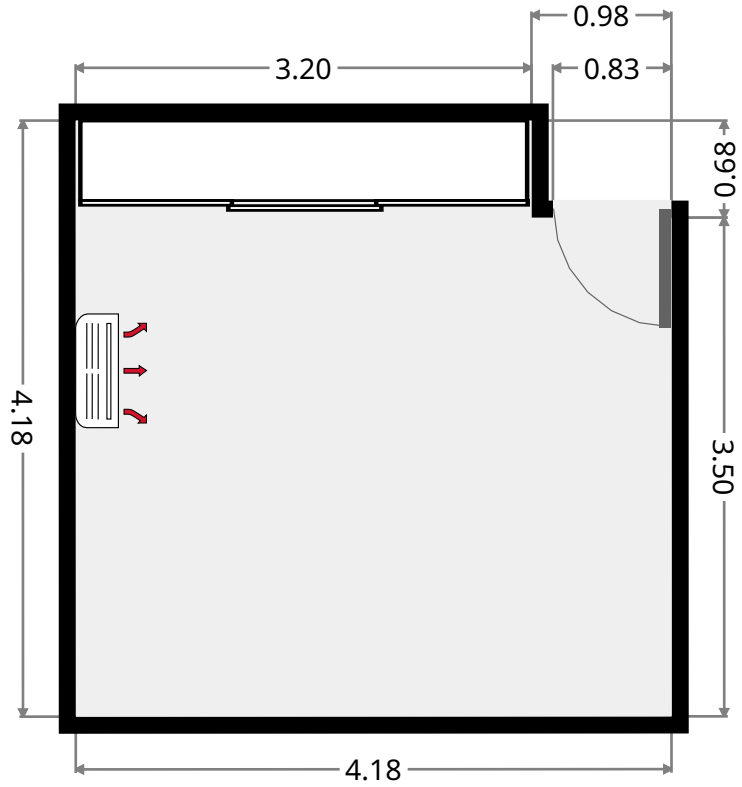
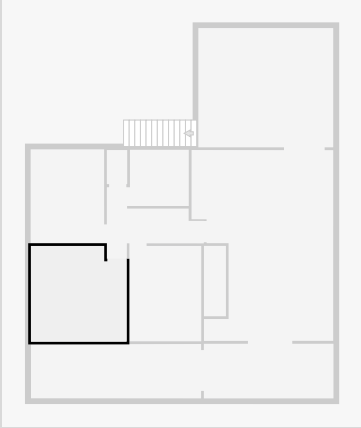

Bedroom

Width: 3.14 m
 Length: 4.17 m
 Area: 13.08 m²
 Perimeter: 14.61 m

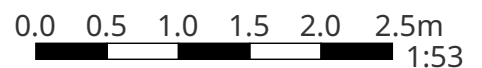
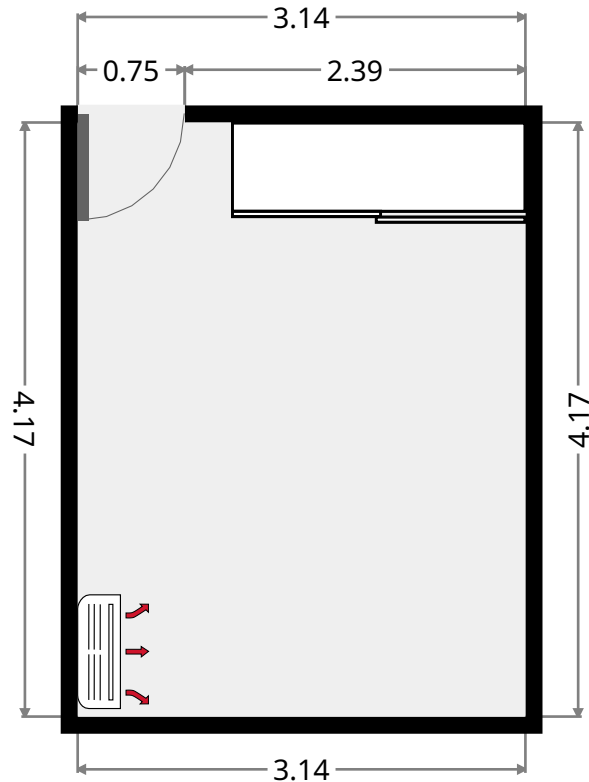
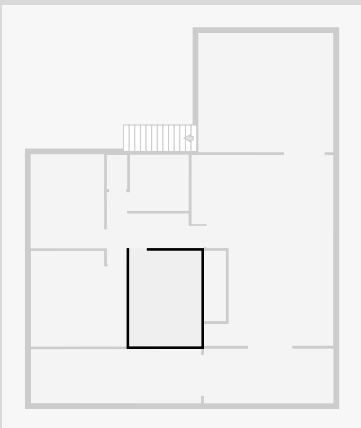

THIS FLOORPLAN IS PROVIDED WITHOUT WARRANTY OF ANY KIND. SENSOPIA DISCLAIMS ANY WARRANTY INCLUDING, WITHOUT LIMITATION, SATISFACTORY QUALITY OR ACCURACY OF DIMENSIONS.

202 Frenchville Road

Dining Room

Width: 2.39 m
Length: 5.66 m
Area: 13.51 m²
Perimeter: 16.10 m

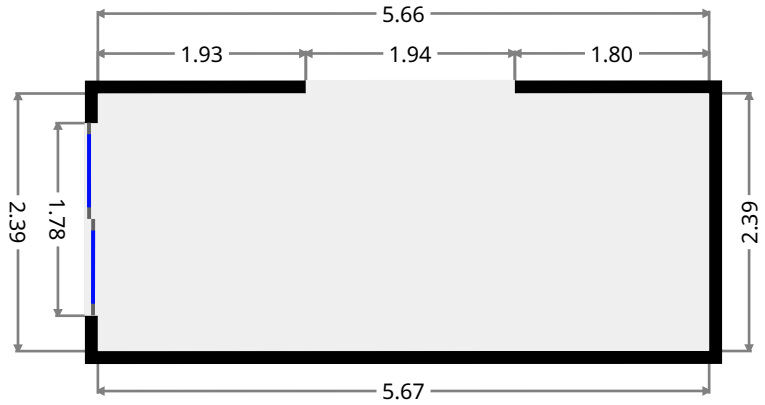
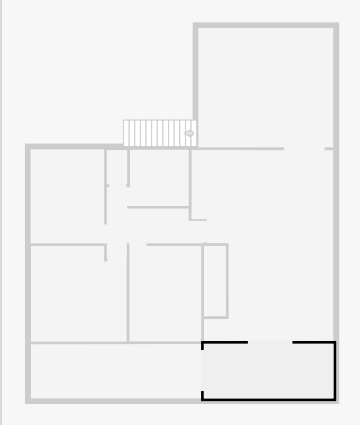

Front Verandah

Width: 2.37 m
Length: 7.43 m
Area: 17.59 m²
Perimeter: 19.60 m

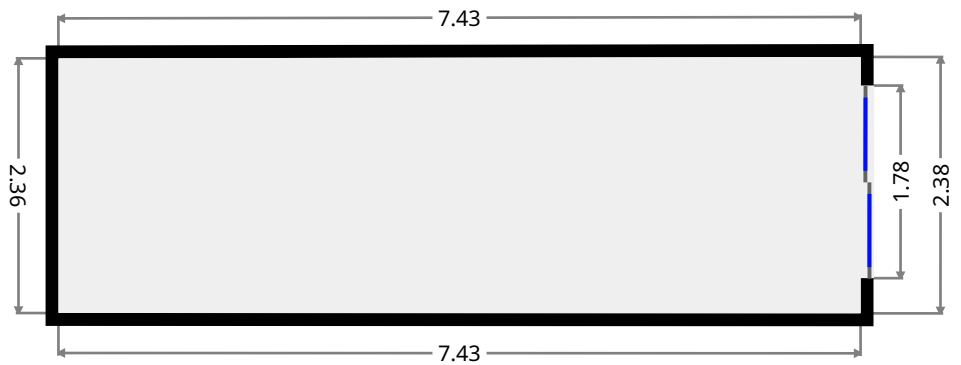
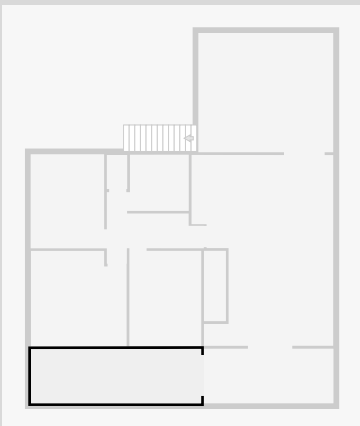

202 Frenchville Road

Rear Deck

Width: 5.21 m
Length: 5.89 m
Area: 30.69 m²
Perimeter: 22.20 m

