

20 Tippett Crescent

Ground Floor

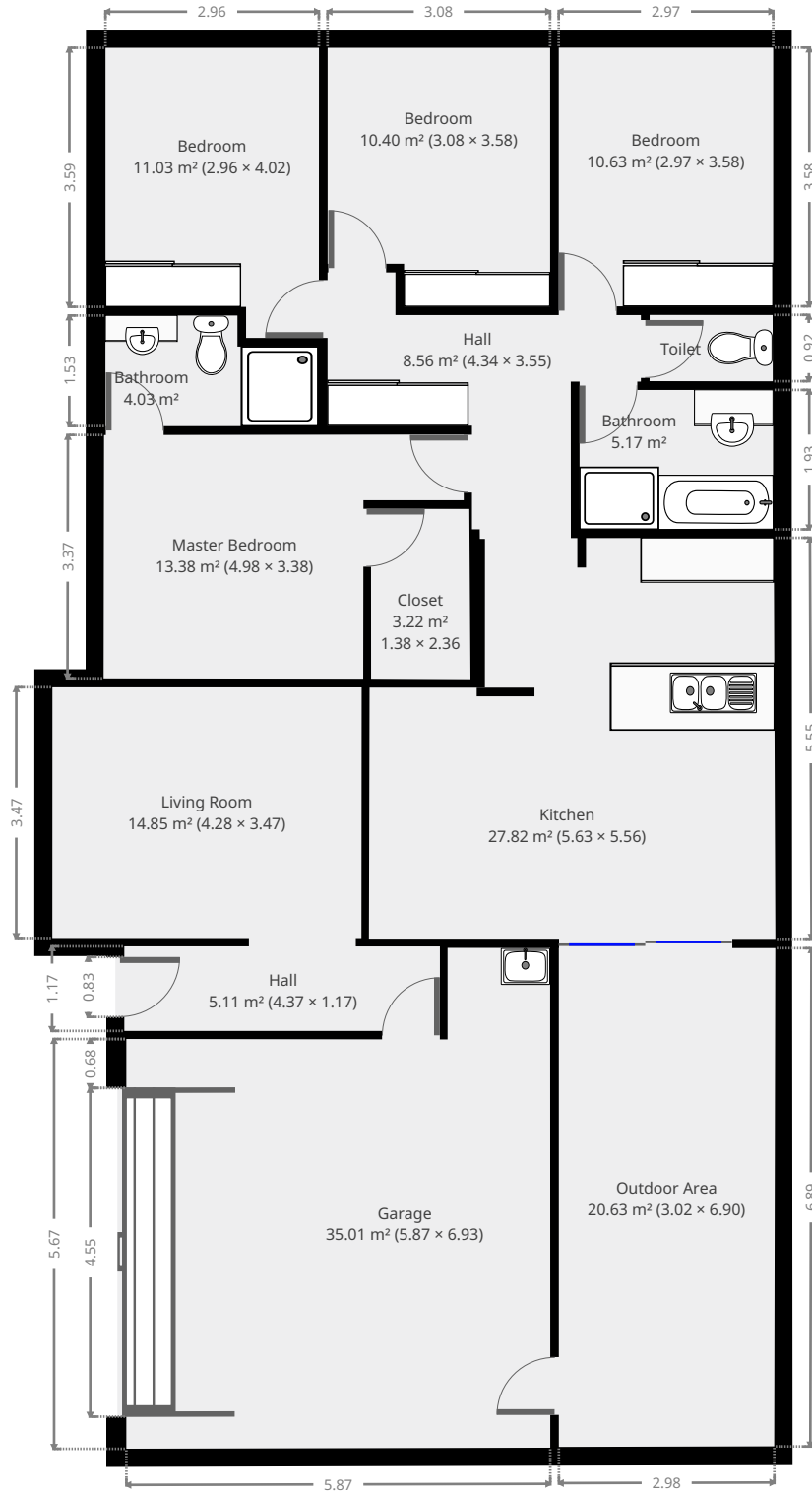

THIS FLOORPLAN IS PROVIDED WITHOUT WARRANTY OF ANY KIND. SENSOPIA DISCLAIMS ANY WARRANTY INCLUDING, WITHOUT LIMITATION, SATISFACTORY QUALITY OR ACCURACY OF DIMENSIONS.



20 Tippett Crescent

Hall

Width: 1.17 m
 Length: 4.37 m
 Area: 5.11 m²
 Perimeter: 11.08 m

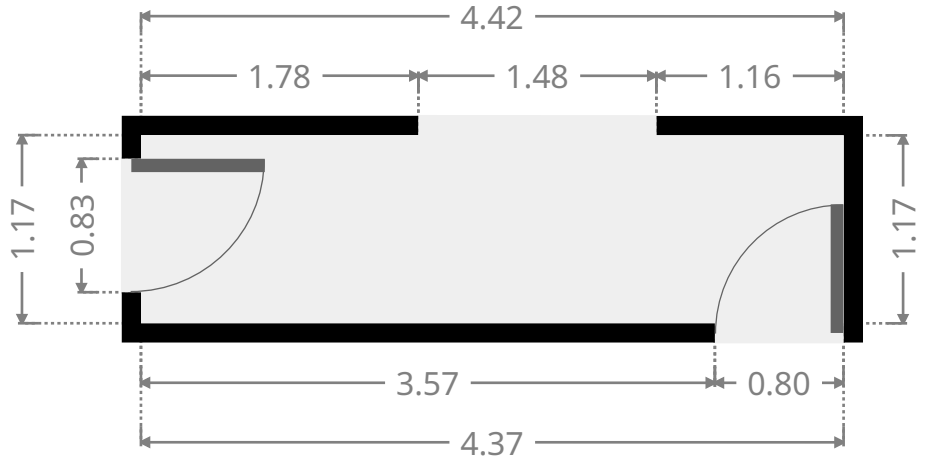

Living Room

Width: 3.47 m
 Length: 4.28 m
 Area: 14.85 m²
 Perimeter: 15.50 m

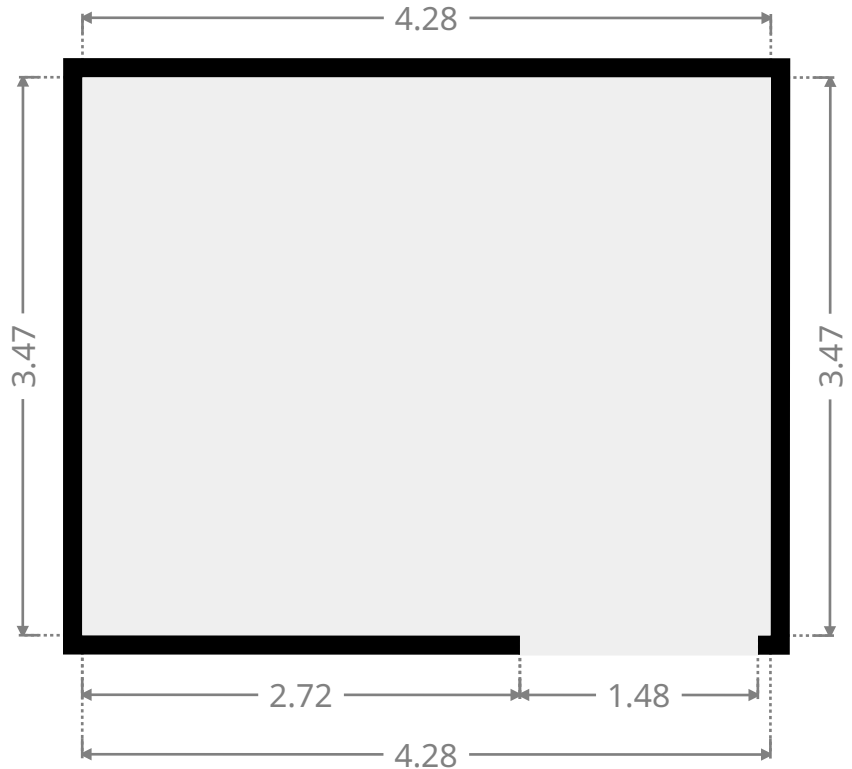
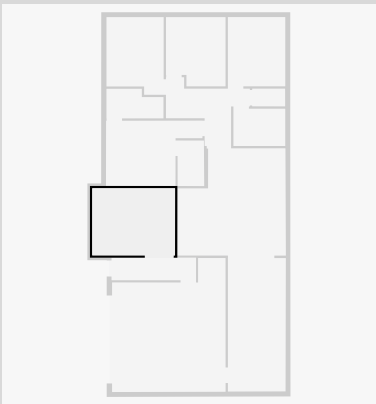

THIS FLOORPLAN IS PROVIDED WITHOUT WARRANTY OF ANY KIND. SENSOPIA DISCLAIMS ANY WARRANTY INCLUDING, WITHOUT LIMITATION, SATISFACTORY QUALITY OR ACCURACY OF DIMENSIONS.

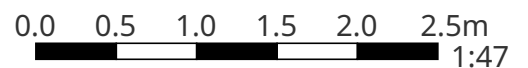

20 Tippett Crescent

Kitchen

Width: 5.56 m
 Length: 5.63 m
 Area: 27.82 m²
 Perimeter: 22.32 m

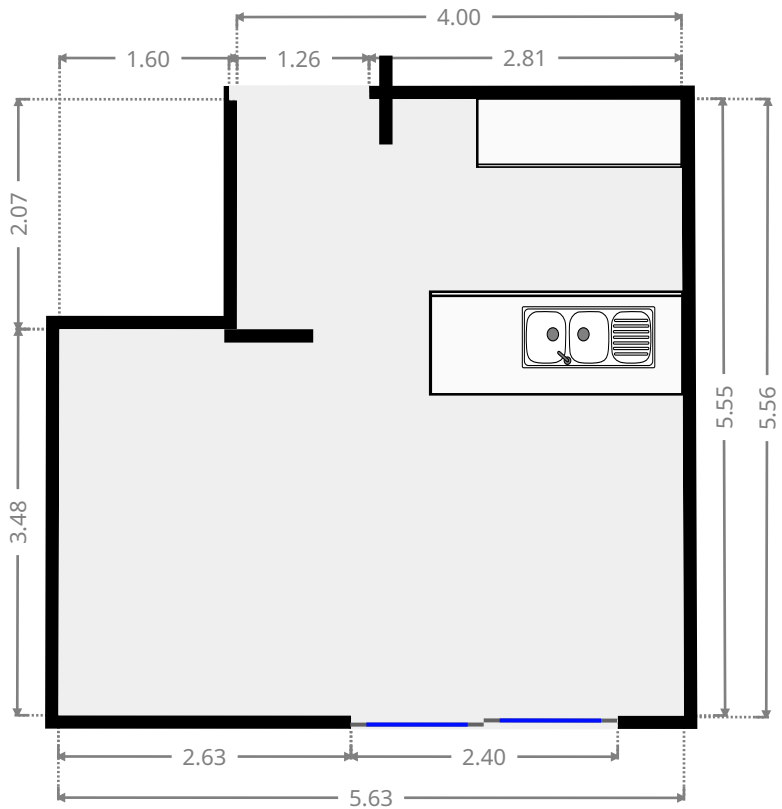
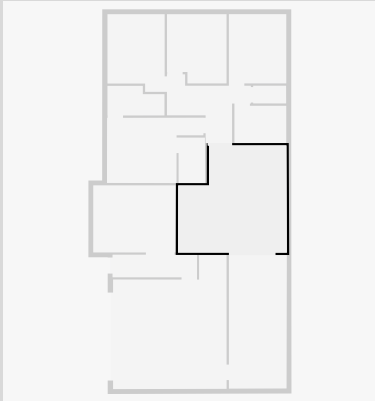

Hall

Width: 3.55 m
 Length: 4.34 m
 Area: 8.56 m²
 Perimeter: 15.79 m

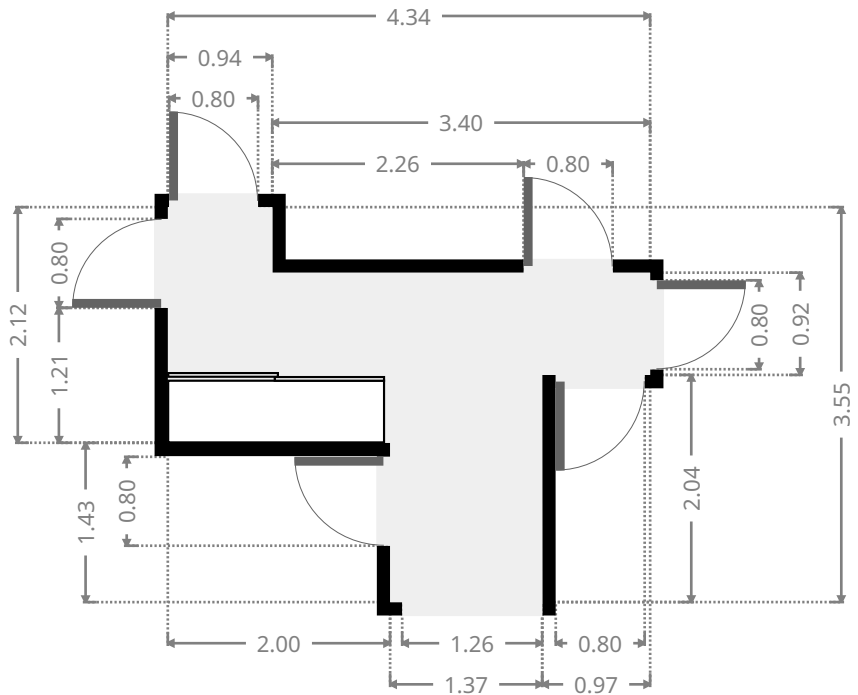
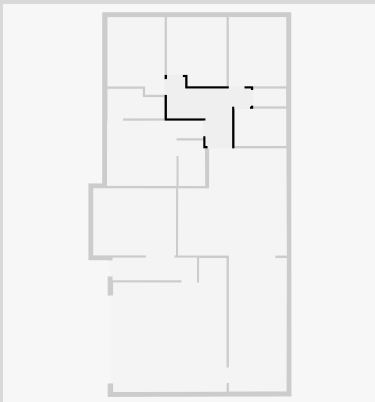

THIS FLOORPLAN IS PROVIDED WITHOUT WARRANTY OF ANY KIND. SENSOPIA DISCLAIMS ANY WARRANTY INCLUDING, WITHOUT LIMITATION, SATISFACTORY QUALITY OR ACCURACY OF DIMENSIONS.

20 Tippett Crescent

Master Bedroom

Width: 3.38 m
 Length: 4.98 m
 Area: 13.38 m²
 Perimeter: 16.71 m

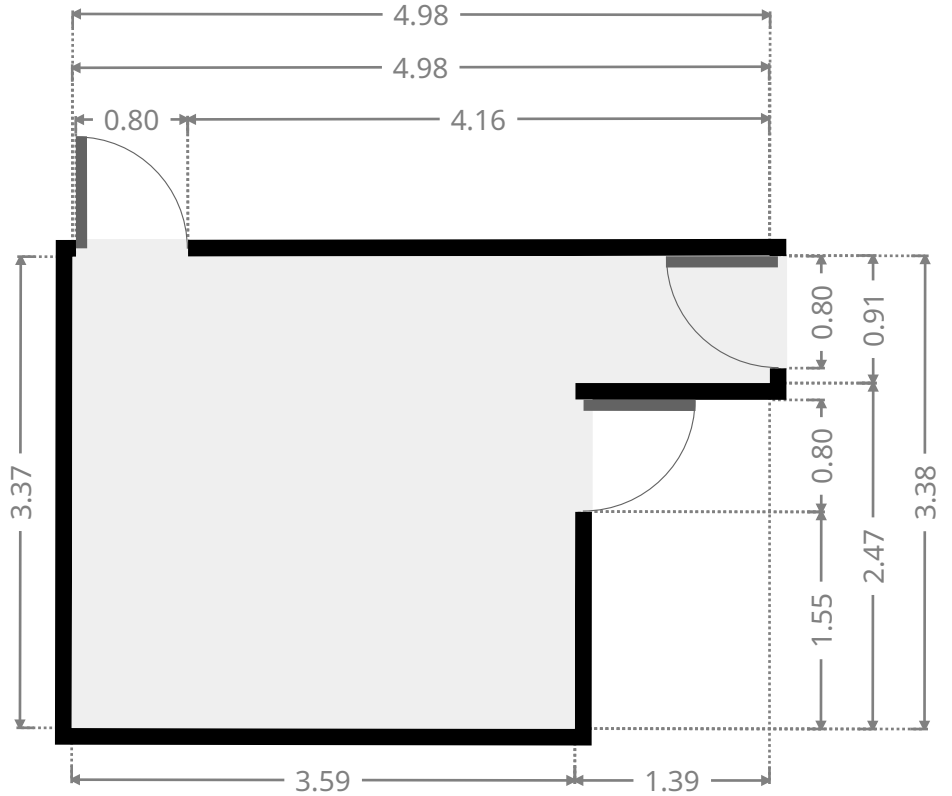
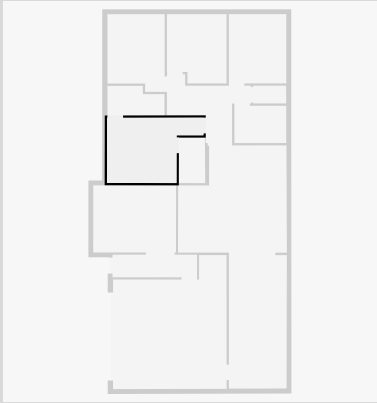

Closet

Width: 1.38 m
 Length: 2.36 m
 Area: 3.22 m²
 Perimeter: 7.44 m

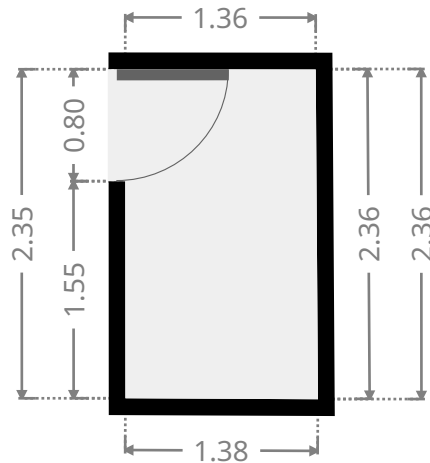
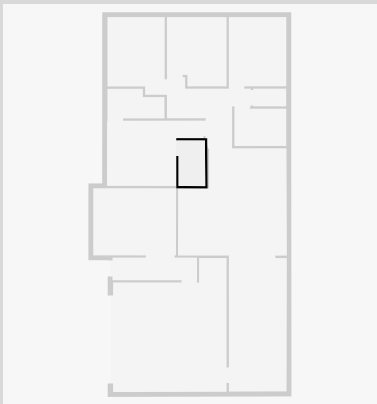

THIS FLOORPLAN IS PROVIDED WITHOUT WARRANTY OF ANY KIND. SENSOPIA DISCLAIMS ANY WARRANTY INCLUDING, WITHOUT LIMITATION, SATISFACTORY QUALITY OR ACCURACY OF DIMENSIONS.

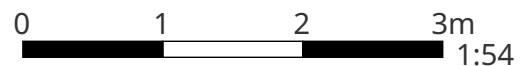

20 Tippett Crescent

Bathroom

Width: 1.53 m
 Length: 2.95 m
 Area: 4.03 m²
 Perimeter: 8.96 m

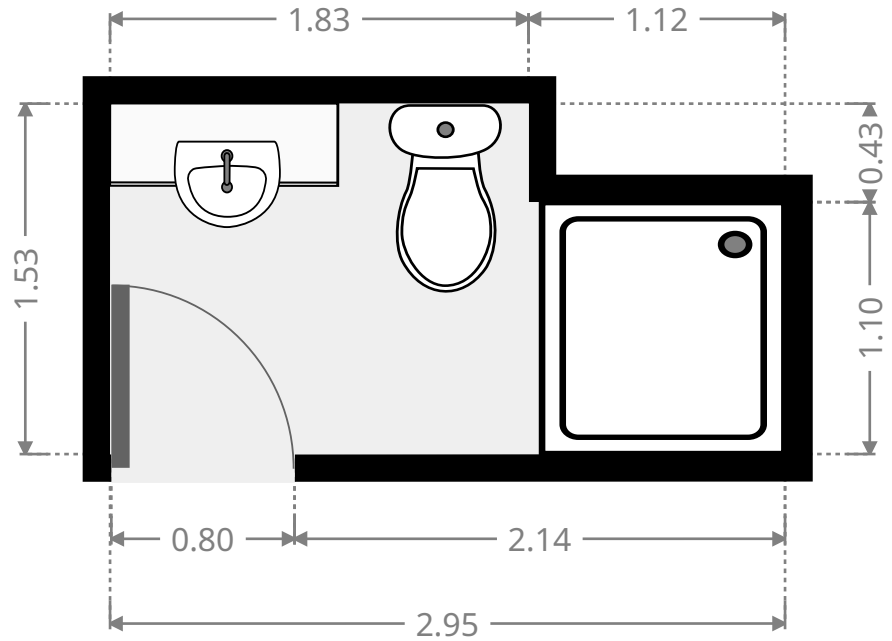
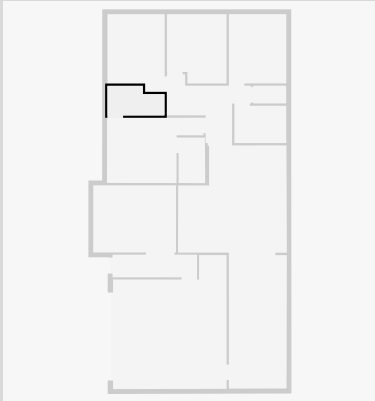

Bathroom

Width: 1.93 m
 Length: 2.68 m
 Area: 5.17 m²
 Perimeter: 9.22 m

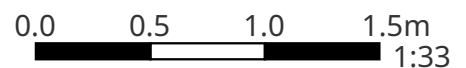
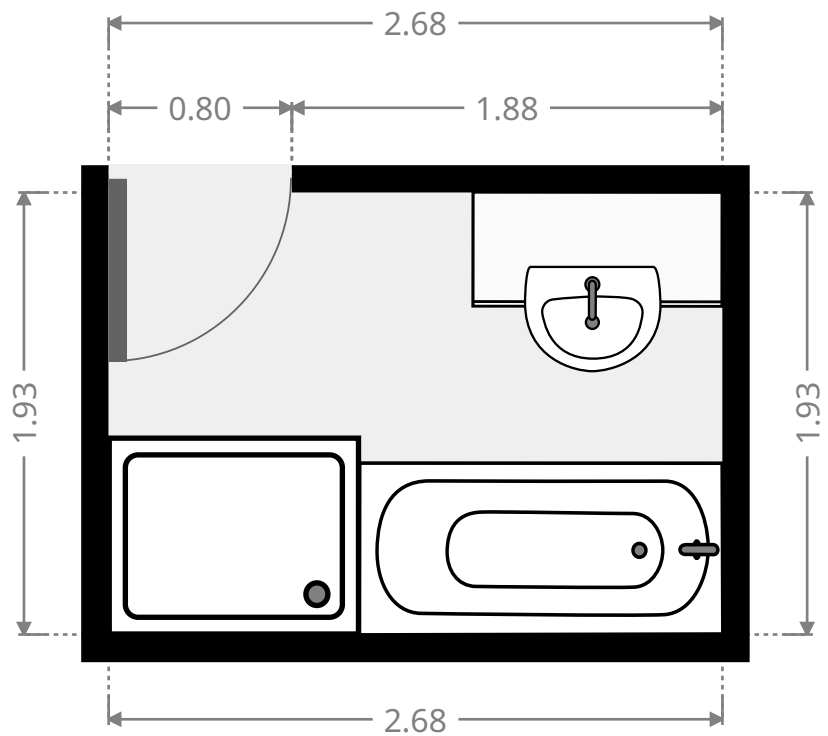
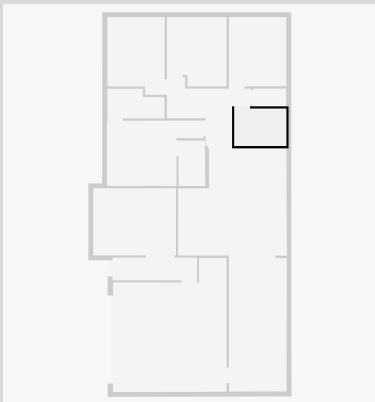

THIS FLOORPLAN IS PROVIDED WITHOUT WARRANTY OF ANY KIND. SENSOPIA DISCLAIMS ANY WARRANTY INCLUDING, WITHOUT LIMITATION, SATISFACTORY QUALITY OR ACCURACY OF DIMENSIONS.

20 Tippett Crescent

Toilet / Half Bath

Width: 0.92 m
Length: 1.71 m
Area: 1.56 m²
Perimeter: 5.24 m

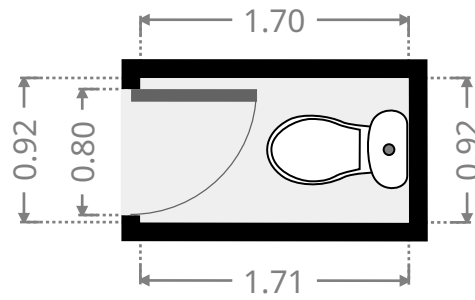
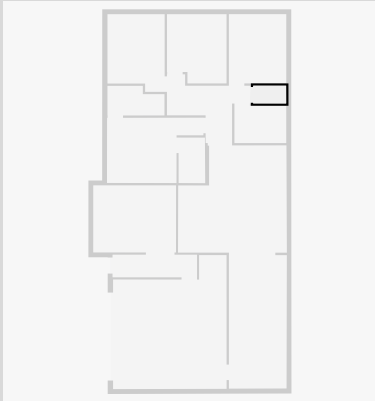

Bedroom

Width: 2.97 m
Length: 3.58 m
Area: 10.63 m²
Perimeter: 13.10 m

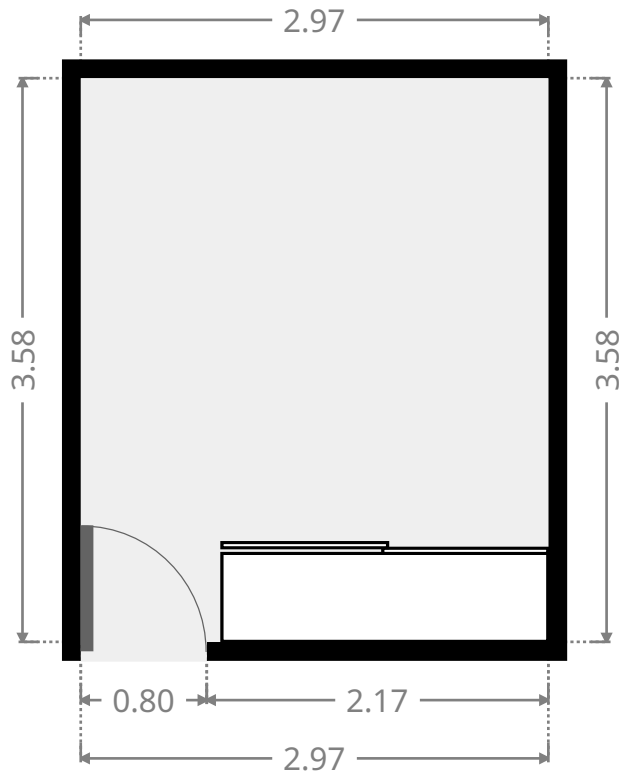
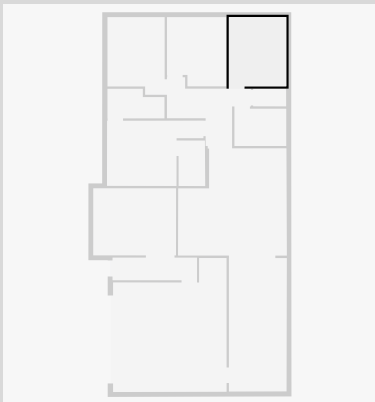

20 Tippett Crescent

Bedroom

Width: 3.08 m
 Length: 3.58 m
 Area: 10.40 m²
 Perimeter: 13.32 m

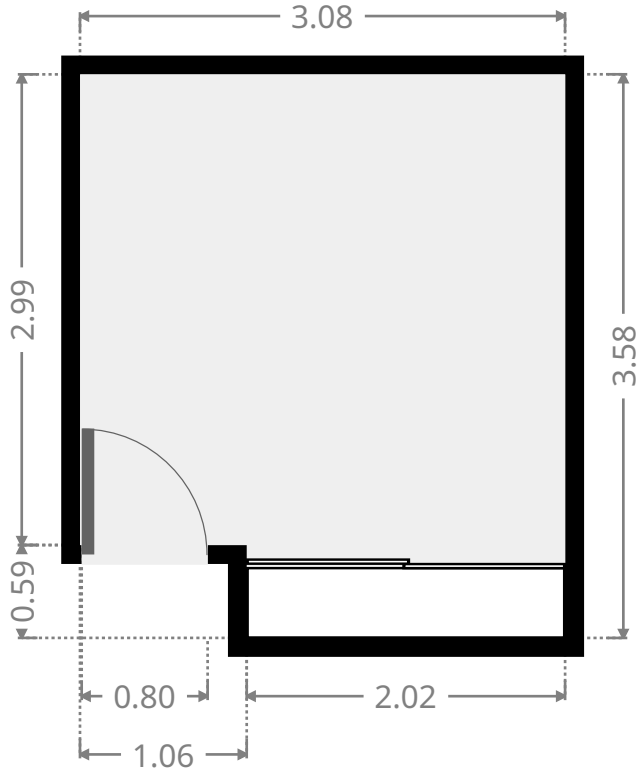
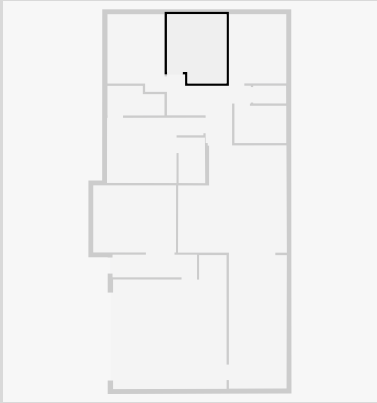

Bedroom

Width: 2.96 m
 Length: 4.02 m
 Area: 11.03 m²
 Perimeter: 13.94 m

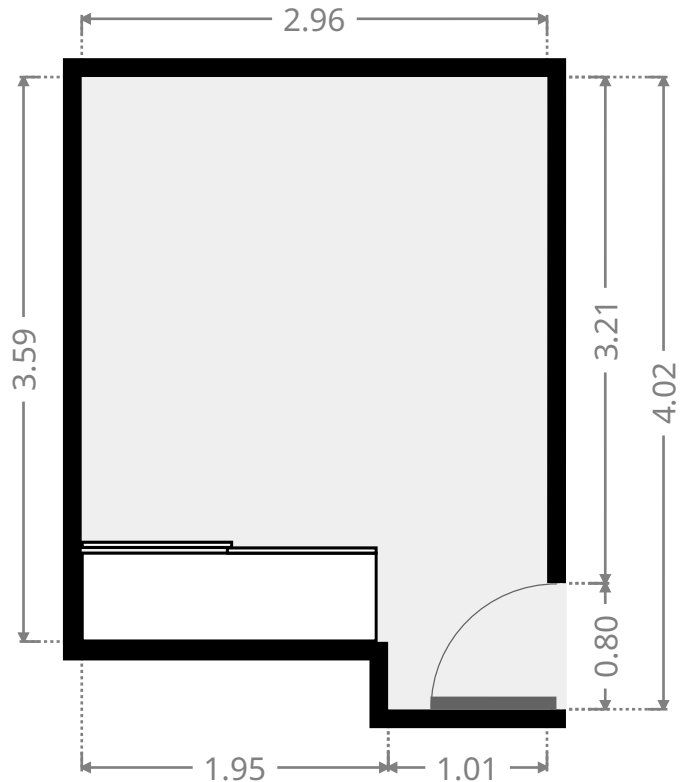
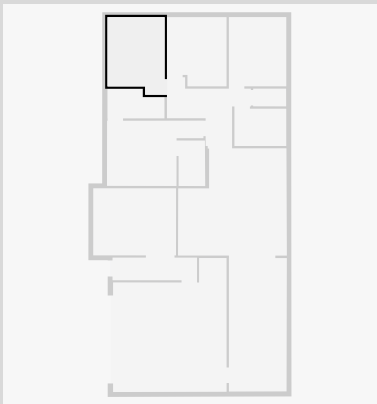

THIS FLOORPLAN IS PROVIDED WITHOUT WARRANTY OF ANY KIND. SENSOPIA DISCLAIMS ANY WARRANTY INCLUDING, WITHOUT LIMITATION, SATISFACTORY QUALITY OR ACCURACY OF DIMENSIONS.

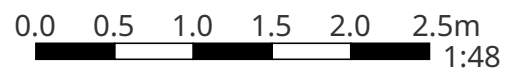

20 Tippett Crescent

Garage

Width: 5.87 m
 Length: 6.93 m
 Area: 35.01 m²
 Perimeter: 25.59 m

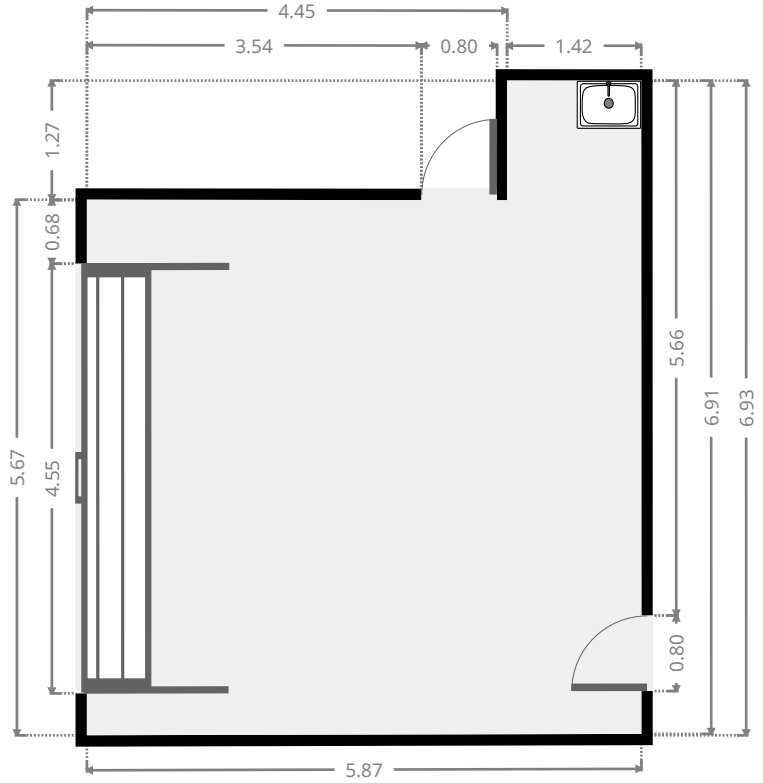
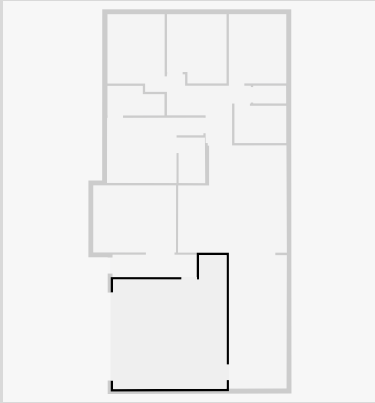

Outdoor Area

Width: 3.02 m
 Length: 6.90 m
 Area: 20.63 m²
 Perimeter: 19.78 m

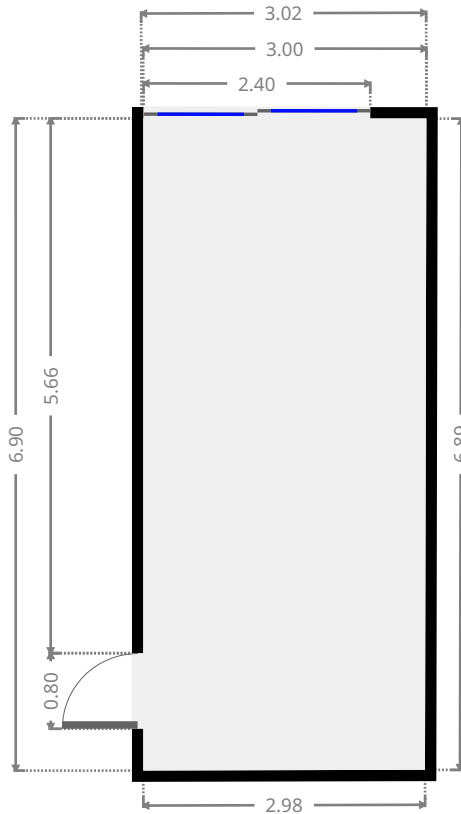
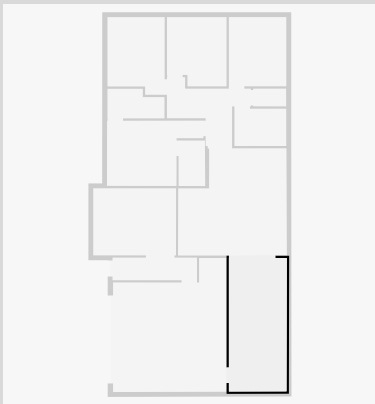

THIS FLOORPLAN IS PROVIDED WITHOUT WARRANTY OF ANY KIND. SENSOPIA DISCLAIMS ANY WARRANTY INCLUDING, WITHOUT LIMITATION, SATISFACTORY QUALITY OR ACCURACY OF DIMENSIONS.