

# Ground Floor



20 Tamarind Avenue

THIS FLOORPLAN IS PROVIDED WITHOUT WARRANTY OF ANY KIND. SENSOPRIA DISCLAIMS ANY WARRANTY INCLUDING, WITHOUT LIMITATION, SATISFACTORY QUALITY OR ACCURACY OF DIMENSIONS.

# Toilet

Width: 0.88 m  
Length: 1.47 m  
Area: 1.28 m<sup>2</sup>  
Perimeter: 4.68 m

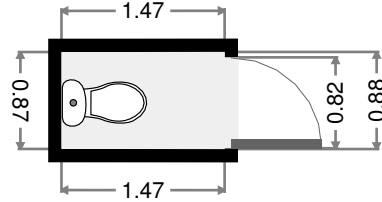
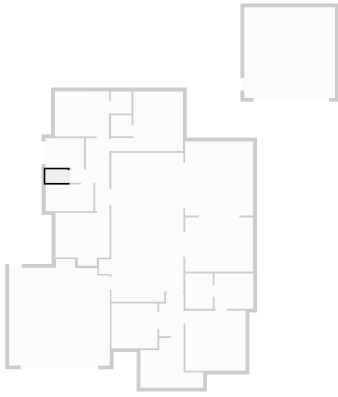

# Shed

Width: 6.00 m  
Length: 6.00 m  
Area: 35.97 m<sup>2</sup>  
Perimeter: 23.99 m

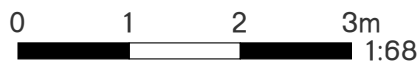
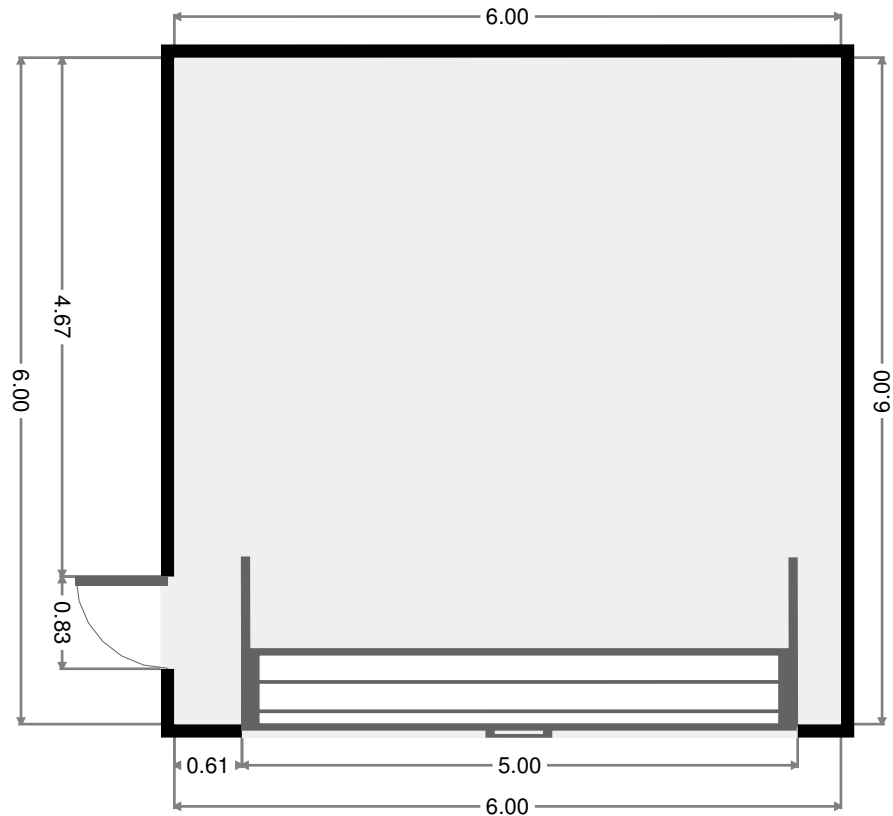
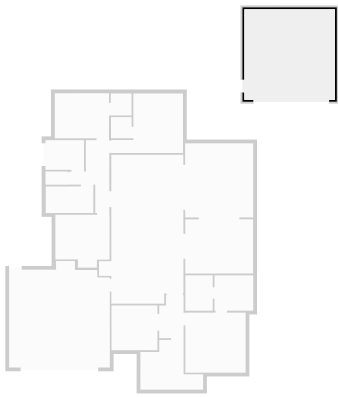

THIS FLOORPLAN IS PROVIDED WITHOUT WARRANTY OF ANY KIND. SENSOPIA DISCLAIMS ANY WARRANTY INCLUDING, WITHOUT LIMITATION, SATISFACTORY QUALITY OR ACCURACY OF DIMENSIONS.

# Foyer

Width: 3.29 m  
 Length: 4.16 m  
 Area: 9.71 m<sup>2</sup>  
 Perimeter: 14.87 m

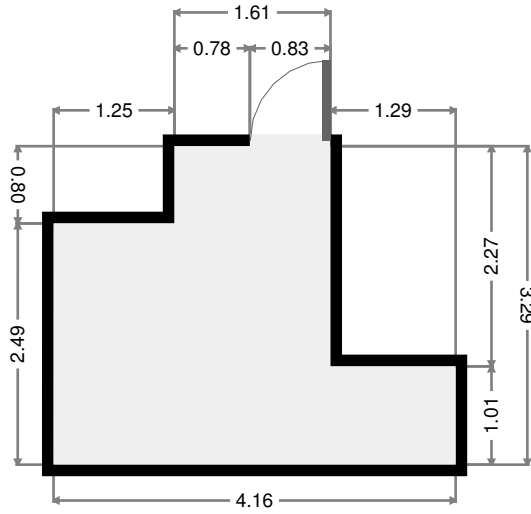
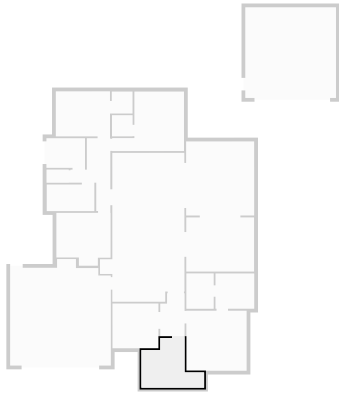

# Garage

Width: 6.66 m  
 Length: 7.05 m  
 Area: 43.34 m<sup>2</sup>  
 Perimeter: 27.41 m

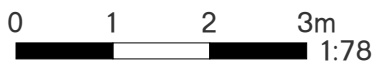
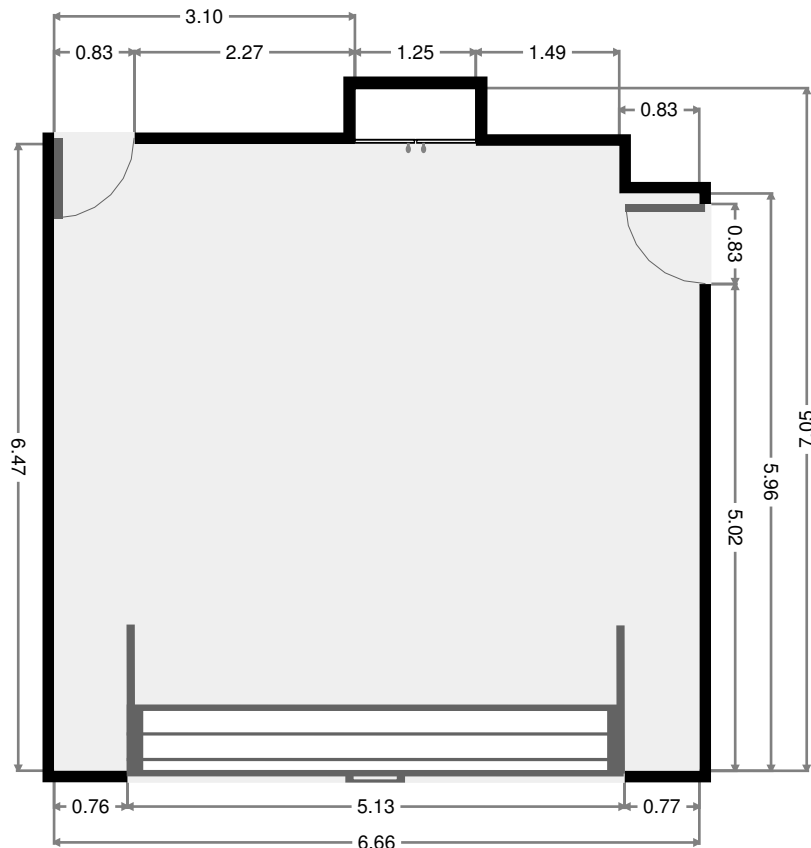
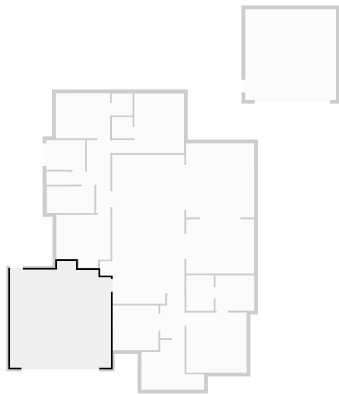

THIS FLOORPLAN IS PROVIDED WITHOUT WARRANTY OF ANY KIND. SENSOPIA DISCLAIMS ANY WARRANTY INCLUDING, WITHOUT LIMITATION, SATISFACTORY QUALITY OR ACCURACY OF DIMENSIONS.

# Alfresco

Width: 4.50 m  
 Length: 4.90 m  
 Area: 22.04 m<sup>2</sup>  
 Perimeter: 18.80 m

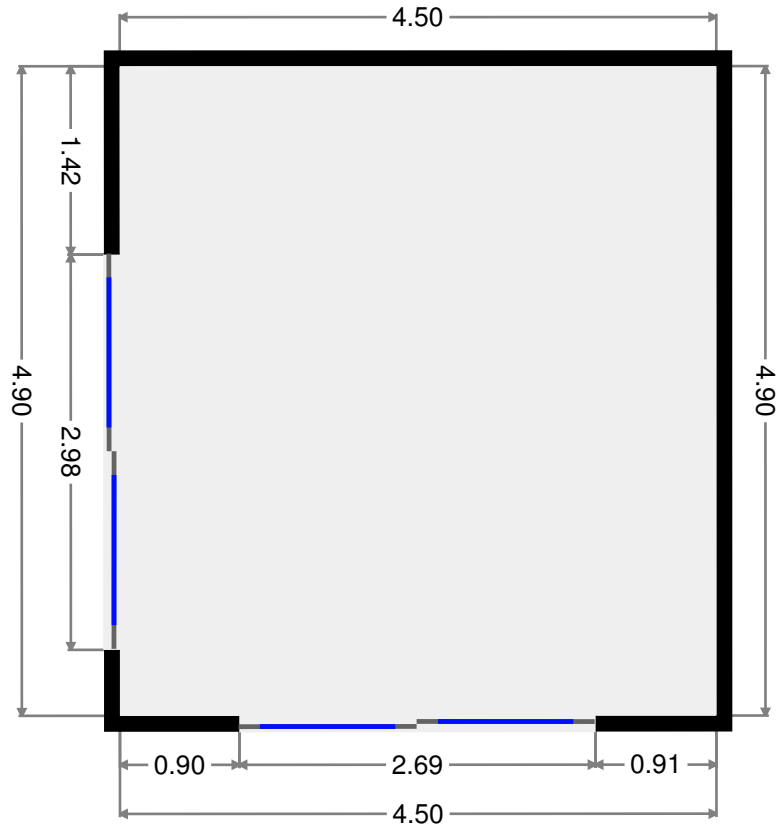
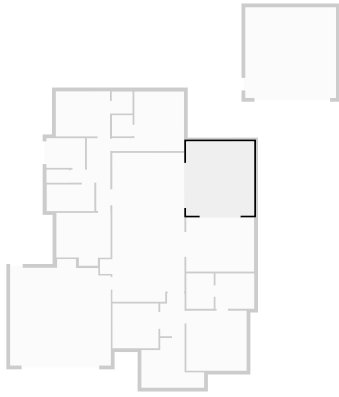

# WIR

Width: 1.36 m  
 Length: 1.40 m  
 Area: 1.91 m<sup>2</sup>  
 Perimeter: 5.53 m

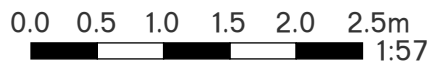
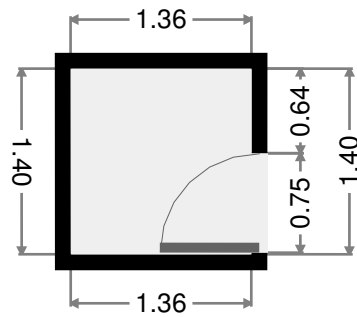
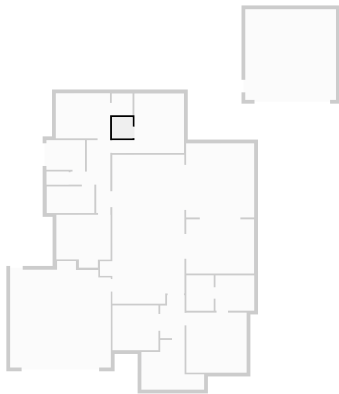

THIS FLOORPLAN IS PROVIDED WITHOUT WARRANTY OF ANY KIND. SENSOPIA DISCLAIMS ANY WARRANTY INCLUDING, WITHOUT LIMITATION, SATISFACTORY QUALITY OR ACCURACY OF DIMENSIONS.

# Bedroom

Width: 3.93 m  
 Length: 4.75 m  
 Area: 14.18 m<sup>2</sup>  
 Perimeter: 17.38 m

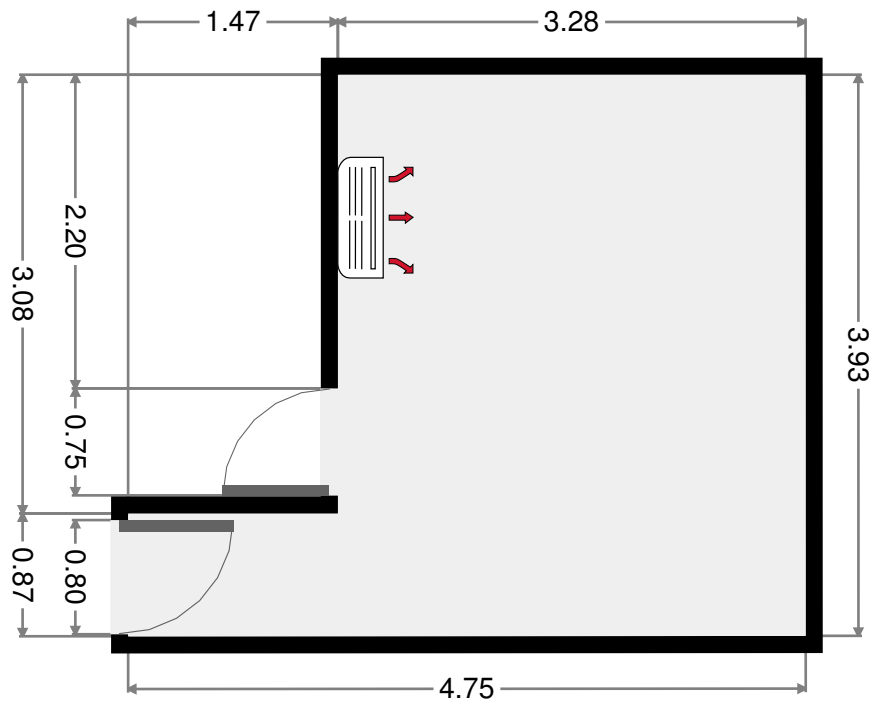
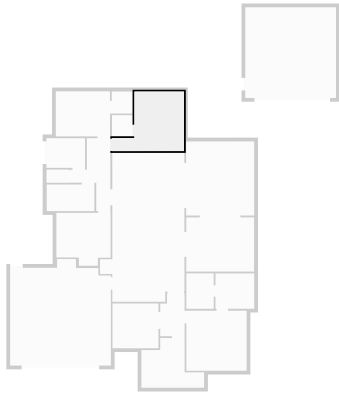

# WIR

Width: 1.38 m  
 Length: 1.45 m  
 Area: 1.99 m<sup>2</sup>  
 Perimeter: 5.65 m

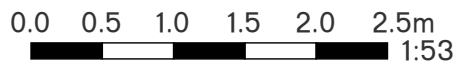
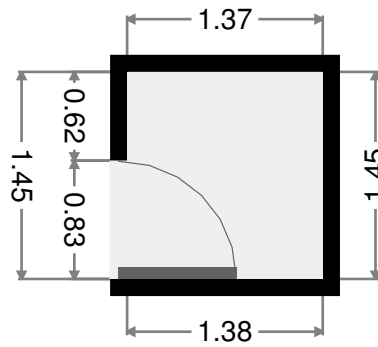
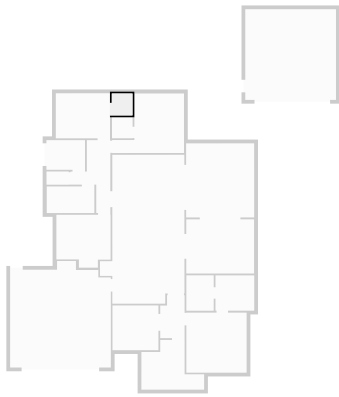

THIS FLOORPLAN IS PROVIDED WITHOUT WARRANTY OF ANY KIND. SENSOPIA DISCLAIMS ANY WARRANTY INCLUDING, WITHOUT LIMITATION, SATISFACTORY QUALITY OR ACCURACY OF DIMENSIONS.

# Bedroom

Width: 2.98 m  
 Length: 3.59 m  
 Area: 10.68 m<sup>2</sup>  
 Perimeter: 13.13 m

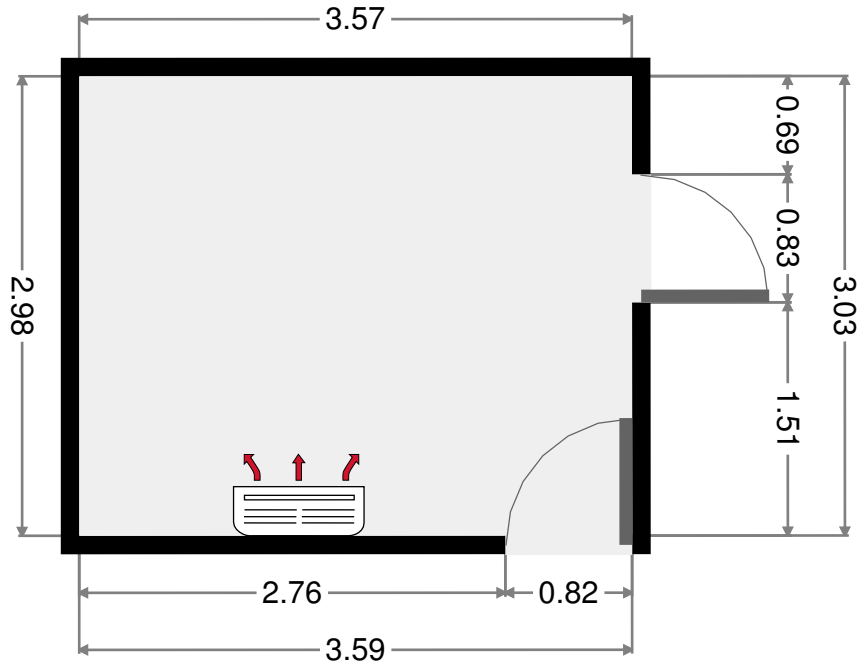
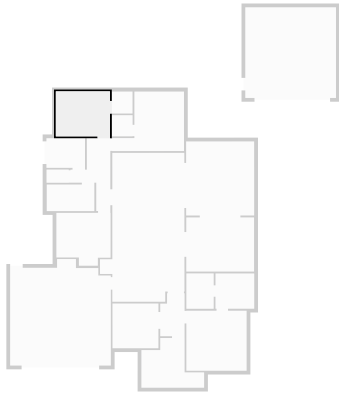

# Laundry Room

Width: 1.96 m  
 Length: 2.55 m  
 Area: 5.00 m<sup>2</sup>  
 Perimeter: 9.02 m

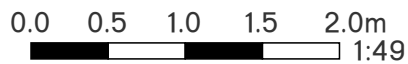
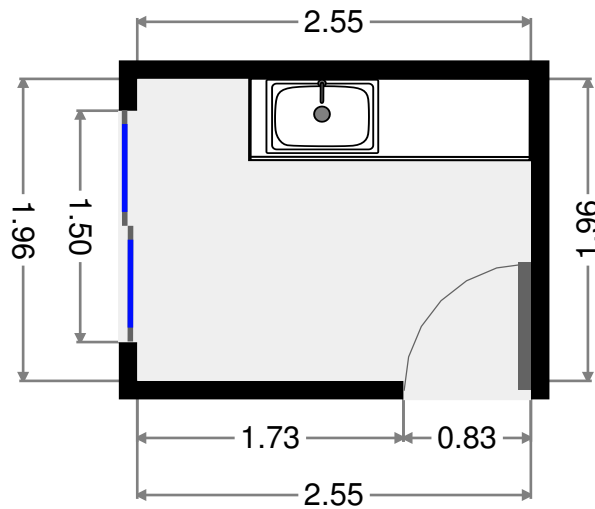
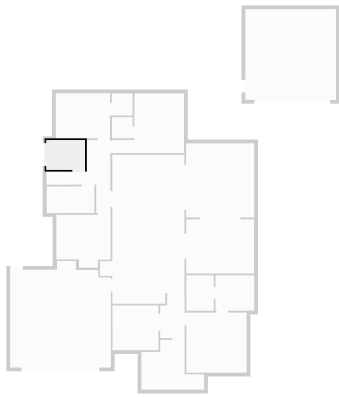

THIS FLOORPLAN IS PROVIDED WITHOUT WARRANTY OF ANY KIND. SENSOPIA DISCLAIMS ANY WARRANTY INCLUDING, WITHOUT LIMITATION, SATISFACTORY QUALITY OR ACCURACY OF DIMENSIONS.

- Width: 1.61 m  
 Length: 2.84 m  
 Area: 4.26 m<sup>2</sup>  
 Perimeter: 8.90 m

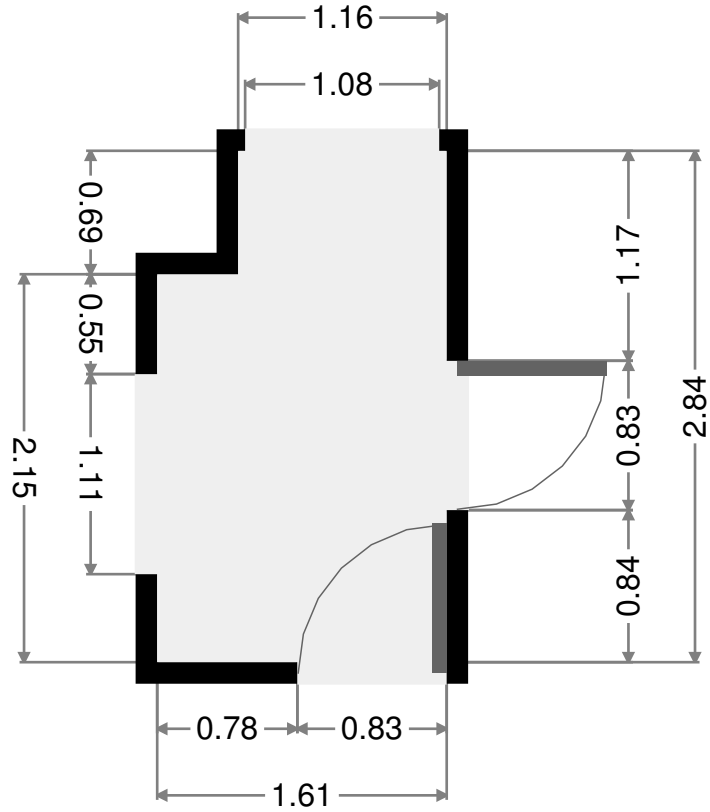
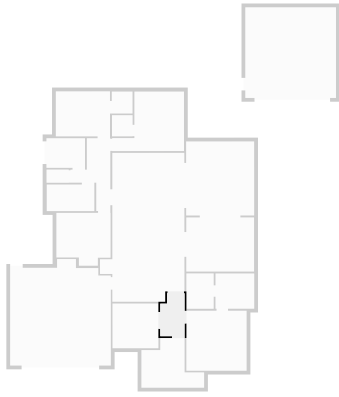

## Bathroom

- Width: 1.76 m  
 Length: 3.15 m  
 Area: 5.54 m<sup>2</sup>  
 Perimeter: 9.82 m

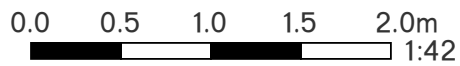
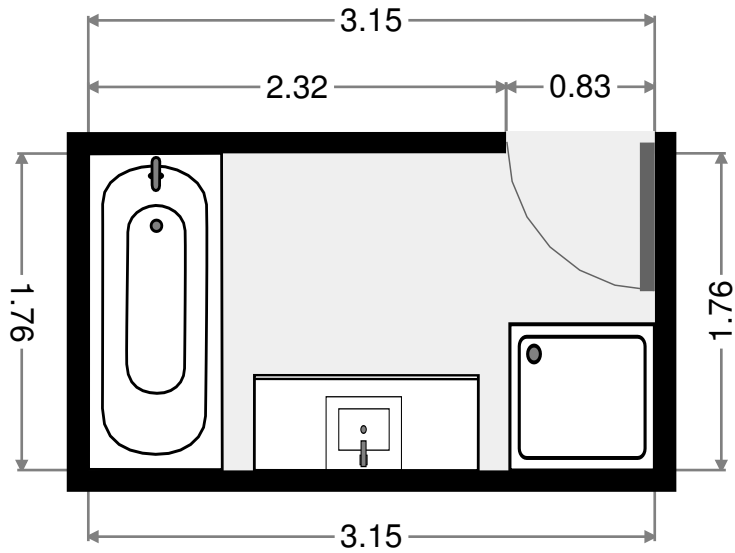
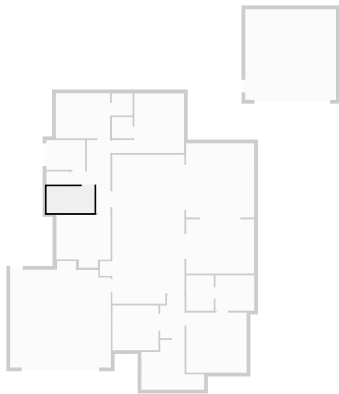

THIS FLOORPLAN IS PROVIDED WITHOUT WARRANTY OF ANY KIND. SENSOPIA DISCLAIMS ANY WARRANTY INCLUDING, WITHOUT LIMITATION, SATISFACTORY QUALITY OR ACCURACY OF DIMENSIONS.

# Bedroom

Width: 3.50 m  
 Length: 3.58 m  
 Area: 11.27 m<sup>2</sup>  
 Perimeter: 14.16 m

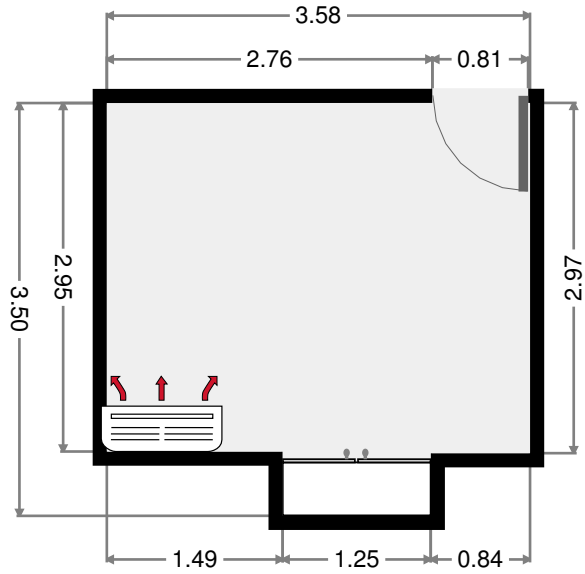
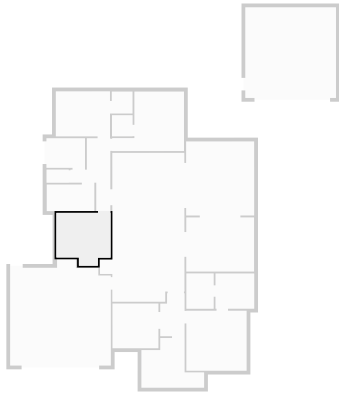

# Hall

Width: 2.64 m  
 Length: 4.81 m  
 Area: 7.24 m<sup>2</sup>  
 Perimeter: 14.90 m

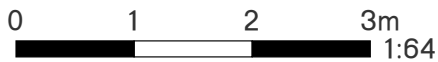
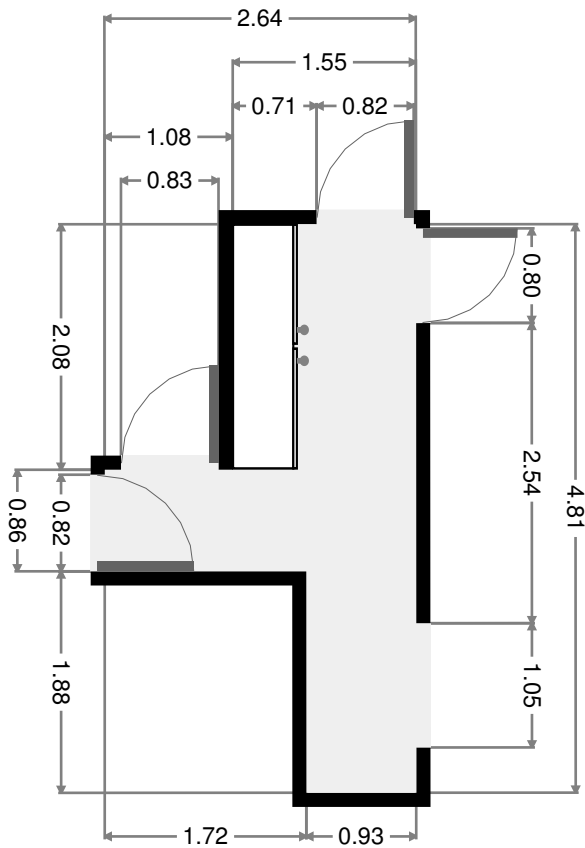
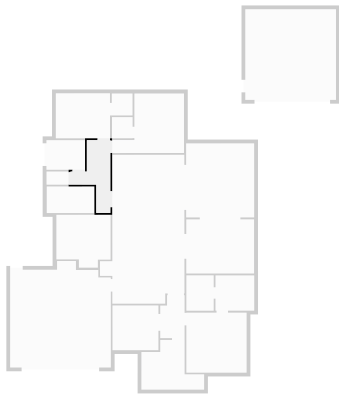

THIS FLOORPLAN IS PROVIDED WITHOUT WARRANTY OF ANY KIND. SENSOPIA DISCLAIMS ANY WARRANTY INCLUDING, WITHOUT LIMITATION, SATISFACTORY QUALITY OR ACCURACY OF DIMENSIONS.



# Living Room

Width: 3.58 m  
 Length: 4.48 m  
 Area: 16.05 m<sup>2</sup>  
 Perimeter: 16.13 m

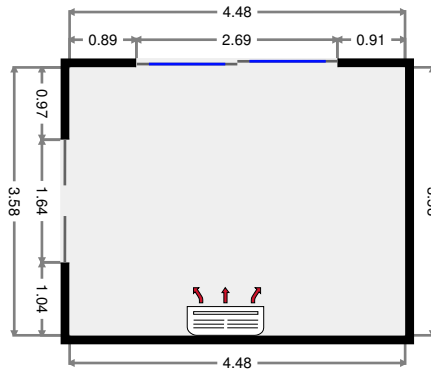
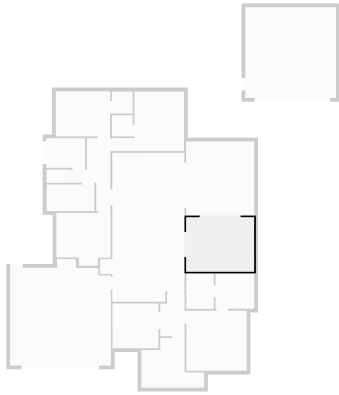

# Kitchen/ Dining / Living

Width: 5.59 m  
 Length: 9.85 m  
 Area: 46.87 m<sup>2</sup>  
 Perimeter: 30.86 m

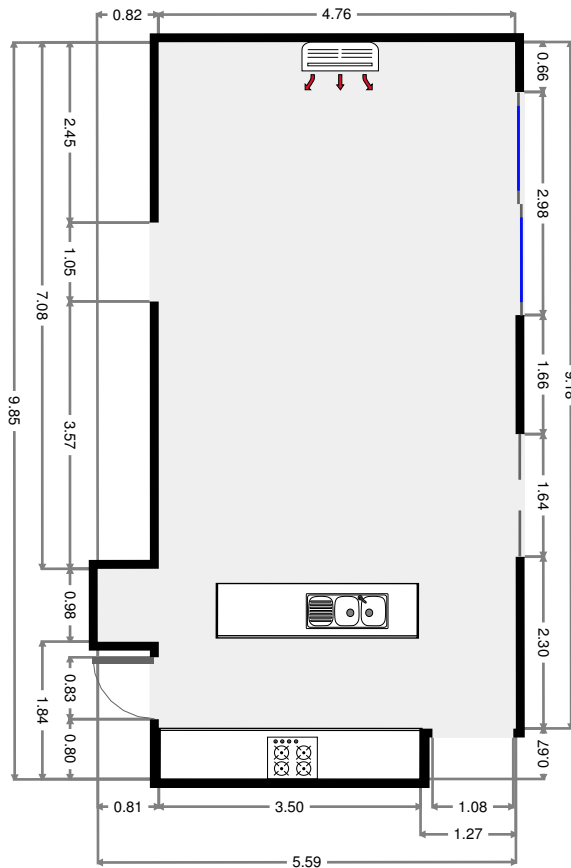
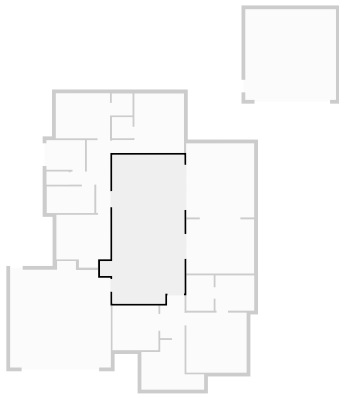

THIS FLOORPLAN IS PROVIDED WITHOUT WARRANTY OF ANY KIND. SENSOPIA DISCLAIMS ANY WARRANTY INCLUDING, WITHOUT LIMITATION, SATISFACTORY QUALITY OR ACCURACY OF DIMENSIONS.

# WIR

Width: 1.81 m  
 Length: 2.34 m  
 Area: 4.23 m<sup>2</sup>  
 Perimeter: 8.29 m

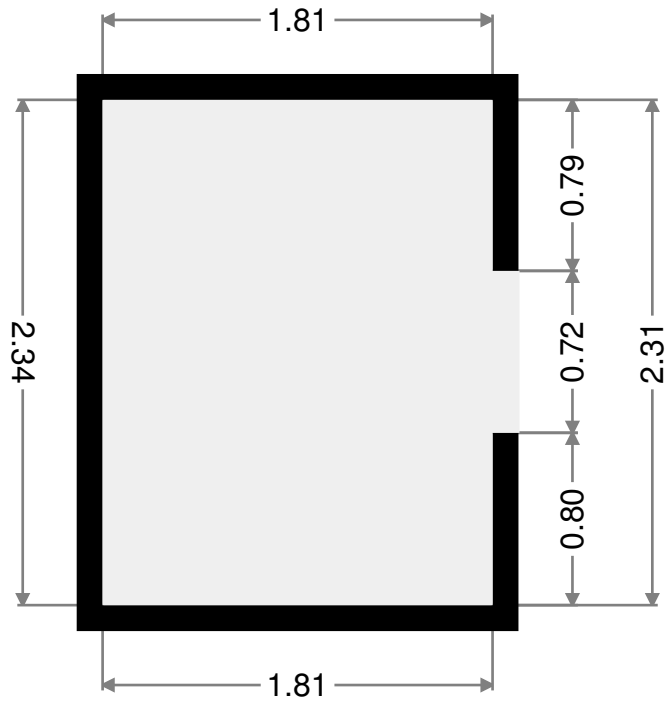
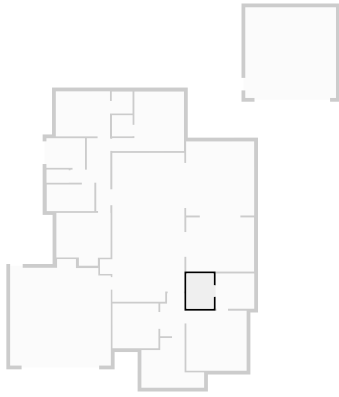

# Bathroom

Width: 2.33 m  
 Length: 2.56 m  
 Area: 5.98 m<sup>2</sup>  
 Perimeter: 9.79 m

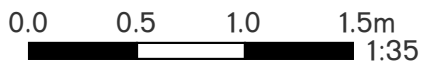
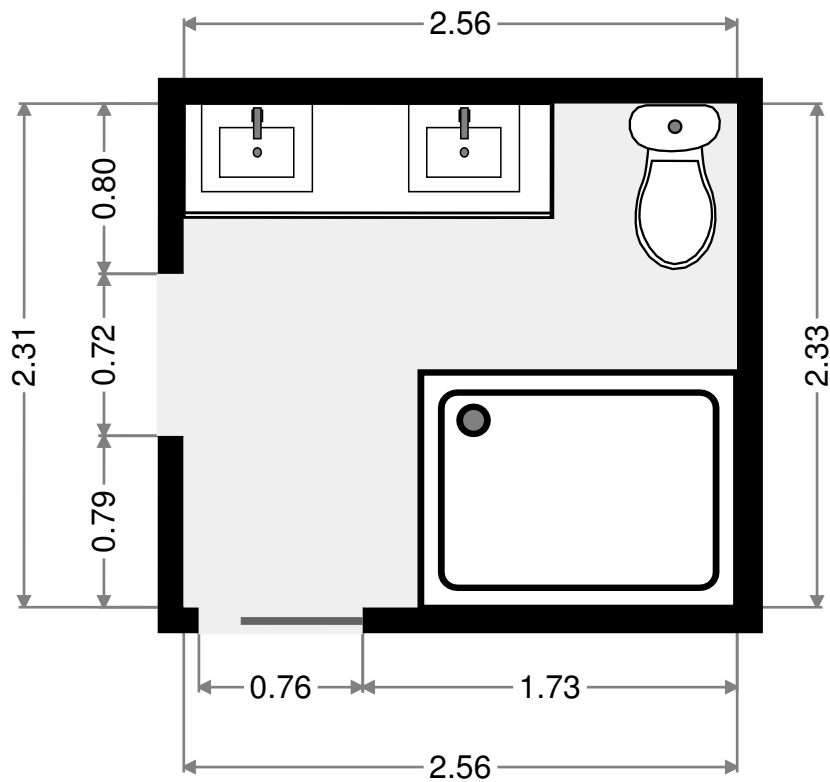
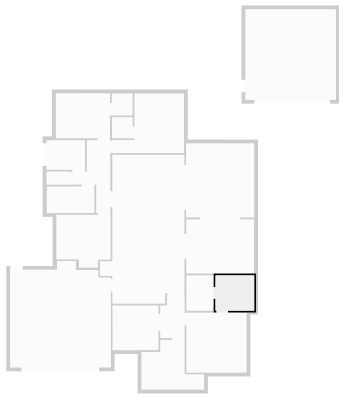

THIS FLOORPLAN IS PROVIDED WITHOUT WARRANTY OF ANY KIND. SENSOPIA DISCLAIMS ANY WARRANTY INCLUDING, WITHOUT LIMITATION, SATISFACTORY QUALITY OR ACCURACY OF DIMENSIONS.

# Master Bedroom

Width: 3.97 m  
 Length: 3.98 m  
 Area: 15.82 m<sup>2</sup>  
 Perimeter: 15.91 m

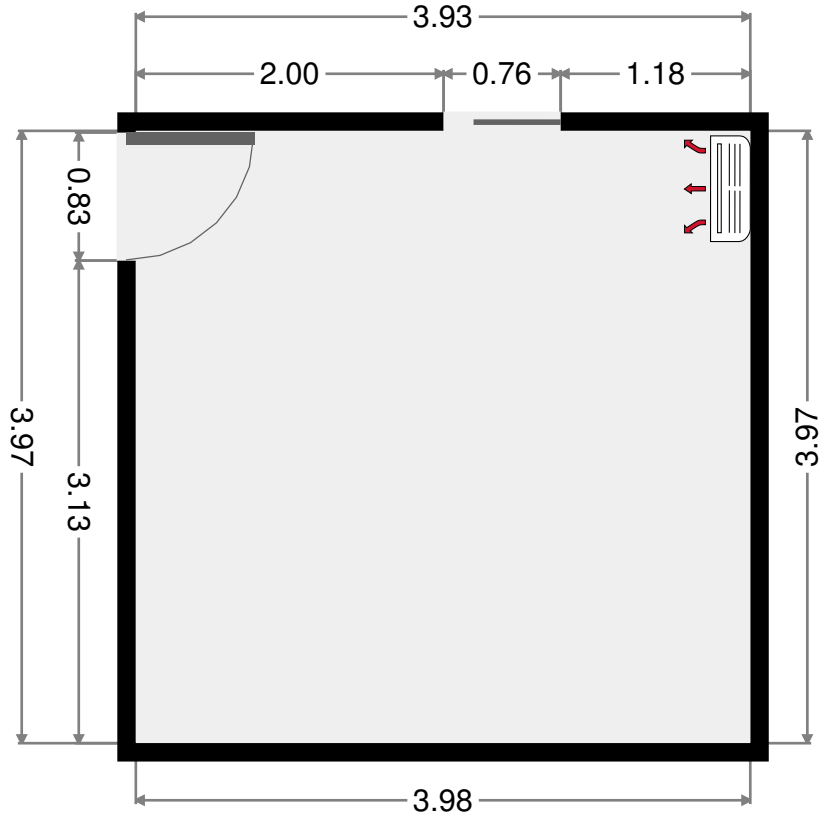

# Study

Width: 2.96 m  
 Length: 3.04 m  
 Area: 8.99 m<sup>2</sup>  
 Perimeter: 12.00 m

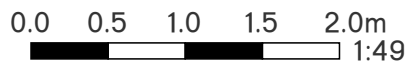
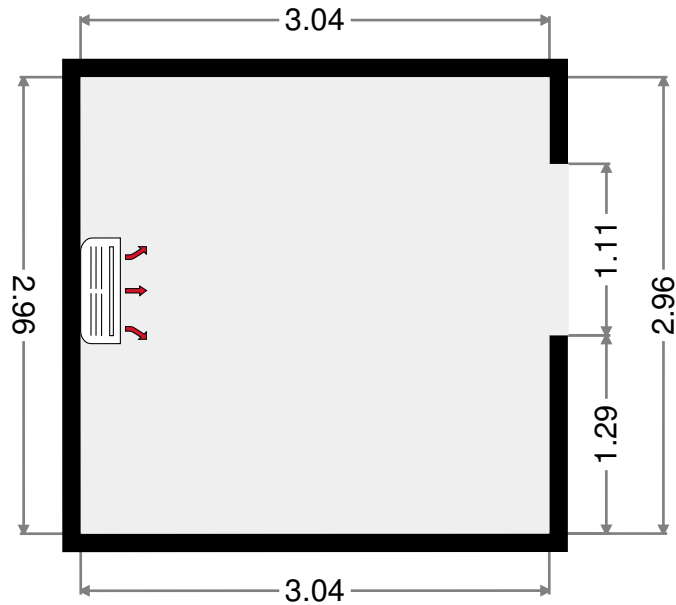
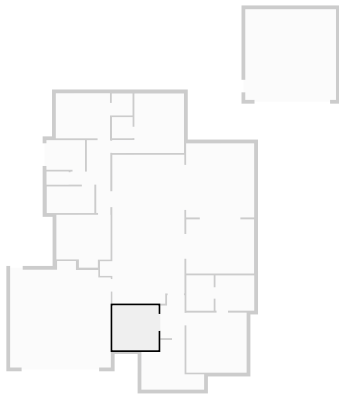

THIS FLOORPLAN IS PROVIDED WITHOUT WARRANTY OF ANY KIND. SENSOPIA DISCLAIMS ANY WARRANTY INCLUDING, WITHOUT LIMITATION, SATISFACTORY QUALITY OR ACCURACY OF DIMENSIONS.