

20 Lilydale Close

Ground Floor

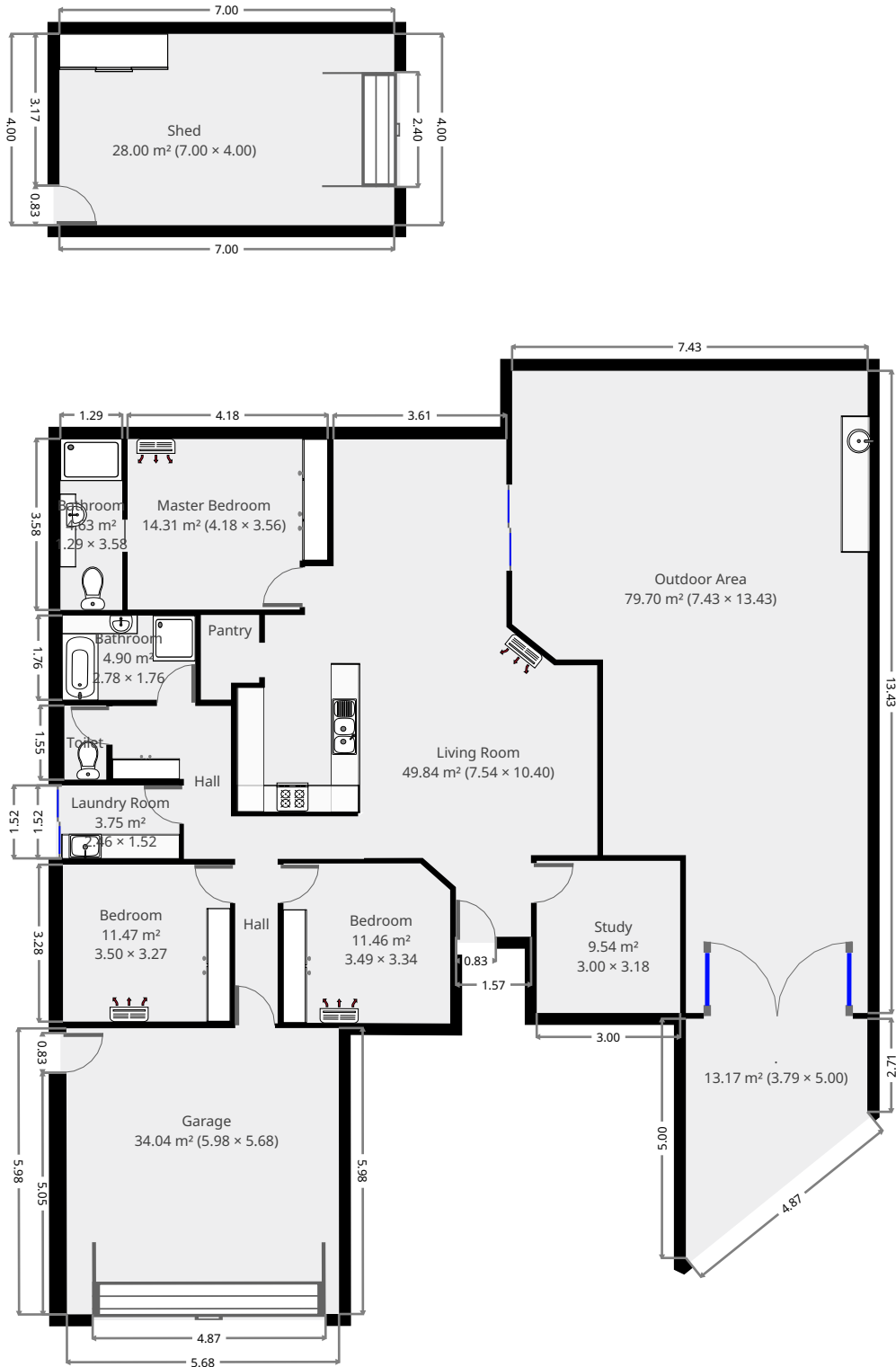

THIS FLOORPLAN IS PROVIDED WITHOUT WARRANTY OF ANY KIND. SENSOPIA DISCLAIMS ANY WARRANTY INCLUDING, WITHOUT LIMITATION, SATISFACTORY QUALITY OR ACCURACY OF DIMENSIONS.



20 Lilydale Close

Living Room

Width: 7.54 m
Length: 10.40 m
Area: 49.84 m²
Perimeter: 34.96 m

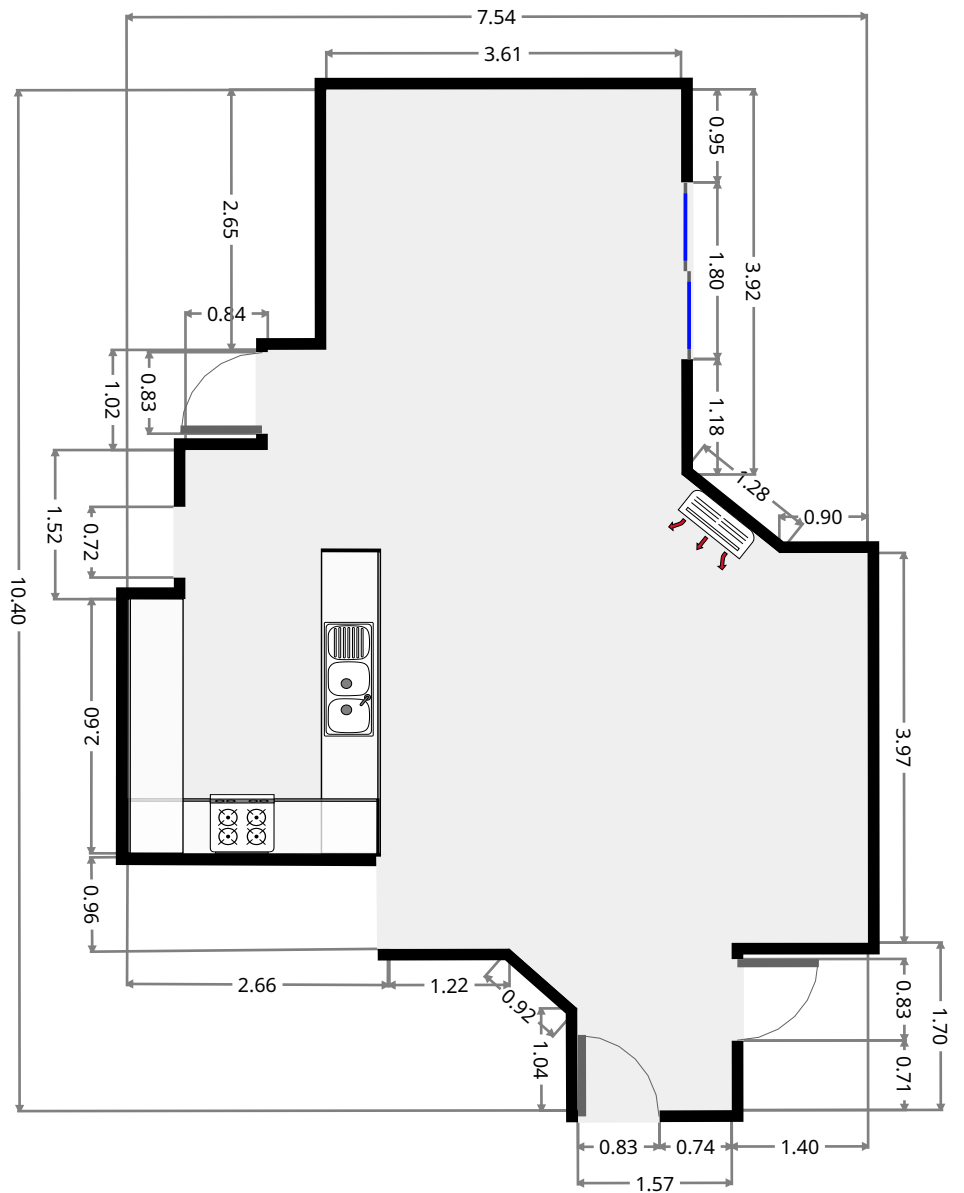
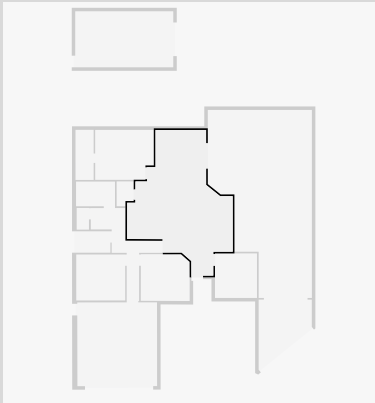

THIS FLOORPLAN IS PROVIDED WITHOUT WARRANTY OF ANY KIND. SENSOPIA DISCLAIMS ANY WARRANTY INCLUDING, WITHOUT LIMITATION, SATISFACTORY QUALITY OR ACCURACY OF DIMENSIONS.

20 Lilydale Close

Pantry

Width: 1.22 m
 Length: 1.77 m
 Area: 1.95 m²
 Perimeter: 5.98 m

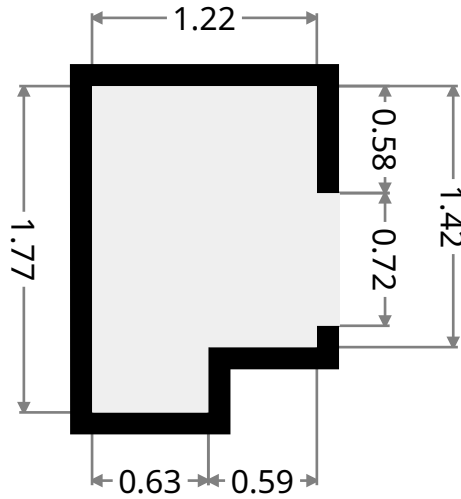
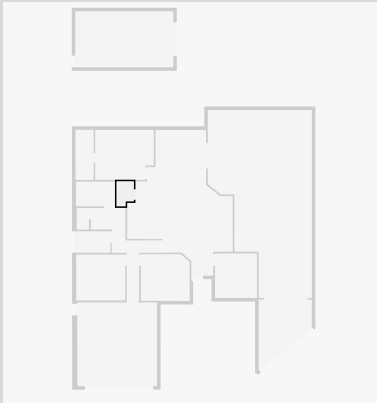

Study

Width: 3.00 m
 Length: 3.18 m
 Area: 9.54 m²
 Perimeter: 12.36 m

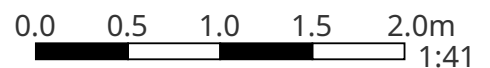
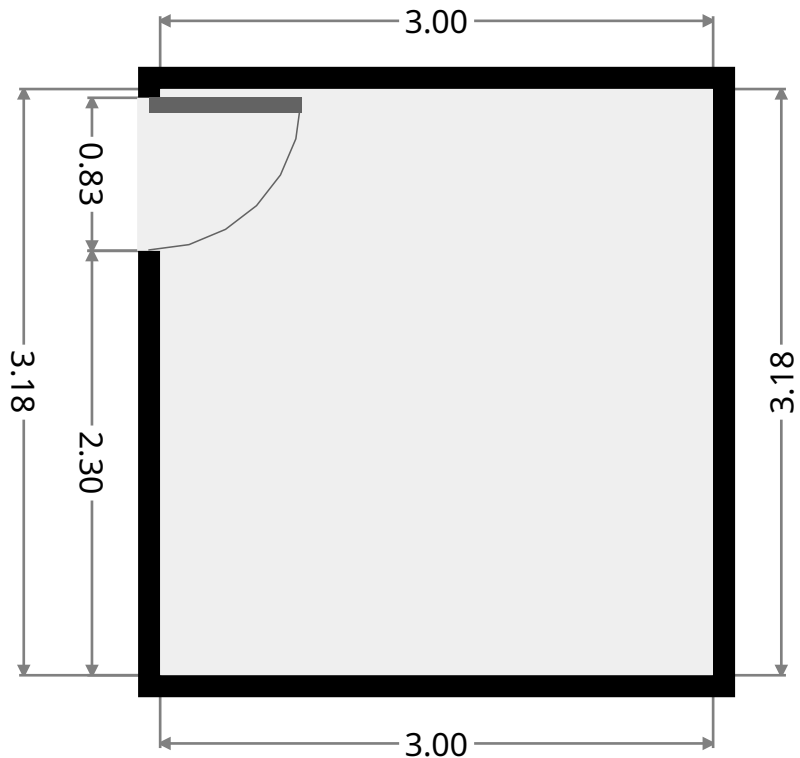
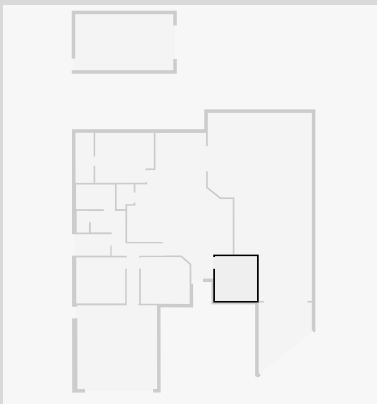

20 Lilydale Close

Hall

Width: 3.20 m
 Length: 5.14 m
 Area: 7.78 m²
 Perimeter: 16.67 m

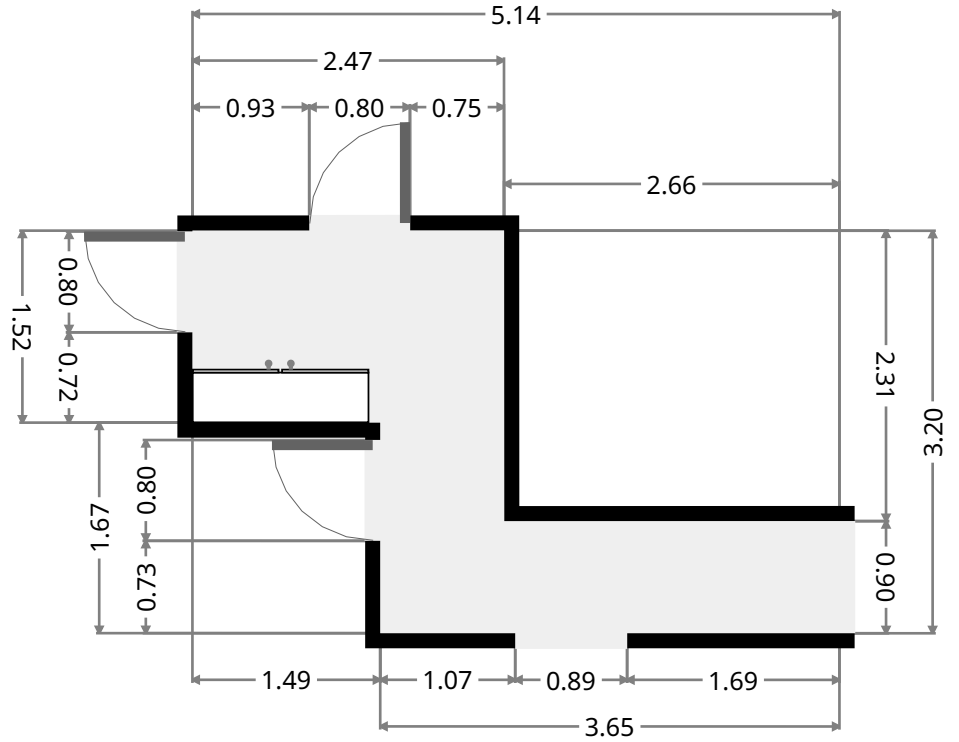
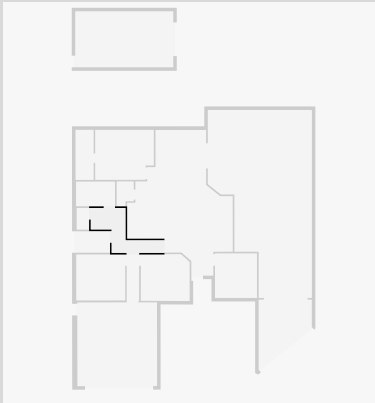

Toilet

Width: 0.88 m
 Length: 1.55 m
 Area: 1.36 m²
 Perimeter: 4.85 m

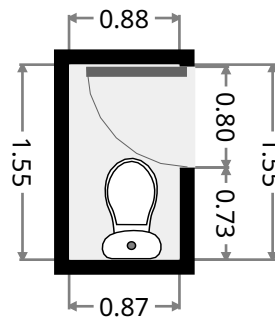
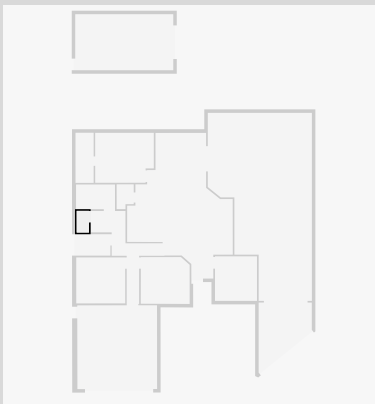

20 Lilydale Close

Bathroom

Width: 1.76 m
 Length: 2.78 m
 Area: 4.90 m²
 Perimeter: 9.08 m

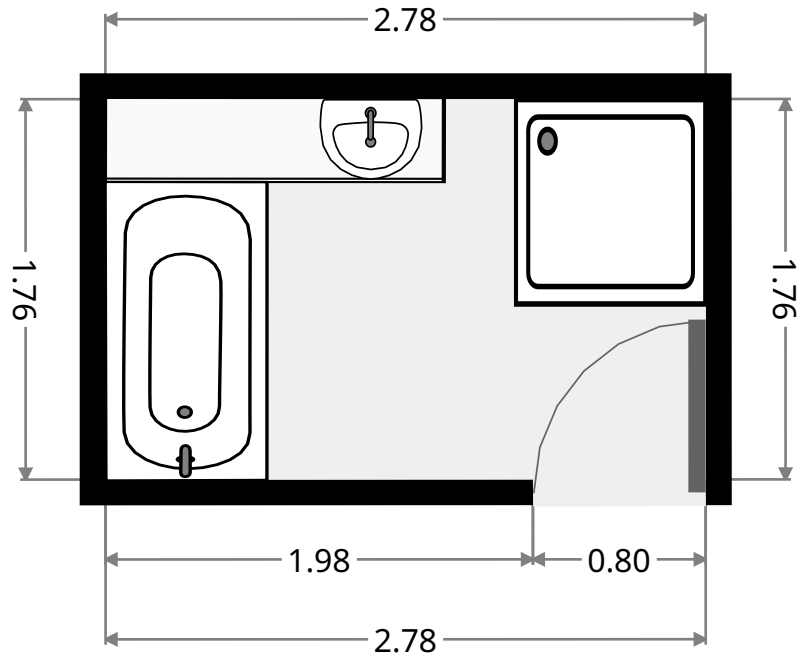
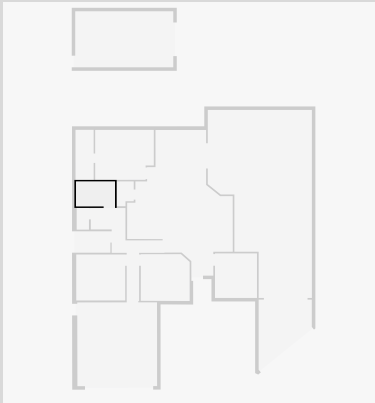

Laundry Room

Width: 1.52 m
 Length: 2.46 m
 Area: 3.75 m²
 Perimeter: 7.97 m

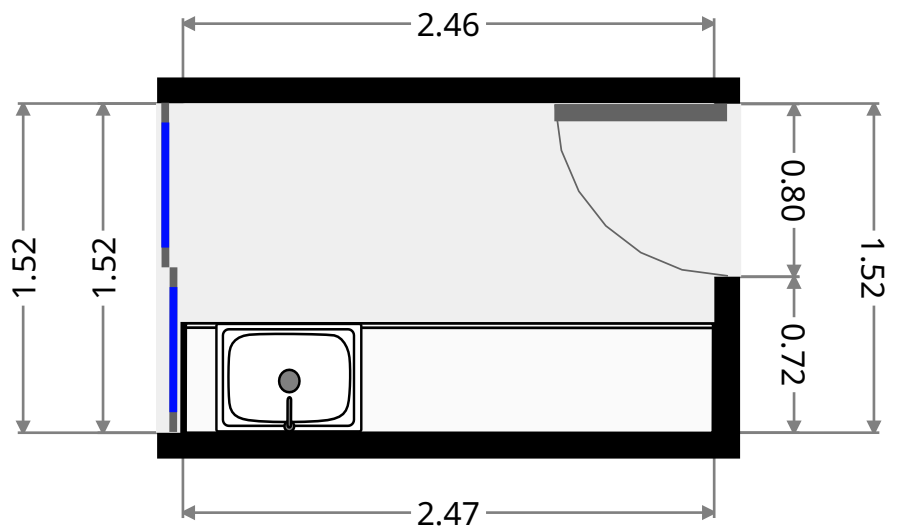
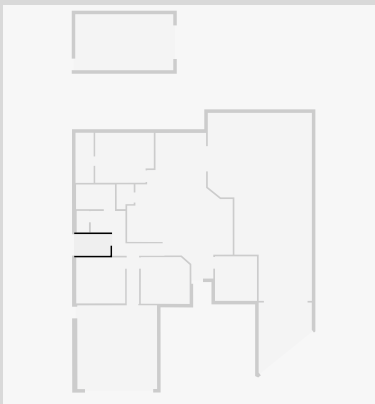

THIS FLOORPLAN IS PROVIDED WITHOUT WARRANTY OF ANY KIND. SENSOPIA DISCLAIMS ANY WARRANTY INCLUDING, WITHOUT LIMITATION, SATISFACTORY QUALITY OR ACCURACY OF DIMENSIONS.

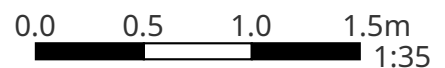

20 Lilydale Close

Hall

Width: 0.89 m
 Length: 3.39 m
 Area: 3.00 m²
 Perimeter: 8.54 m

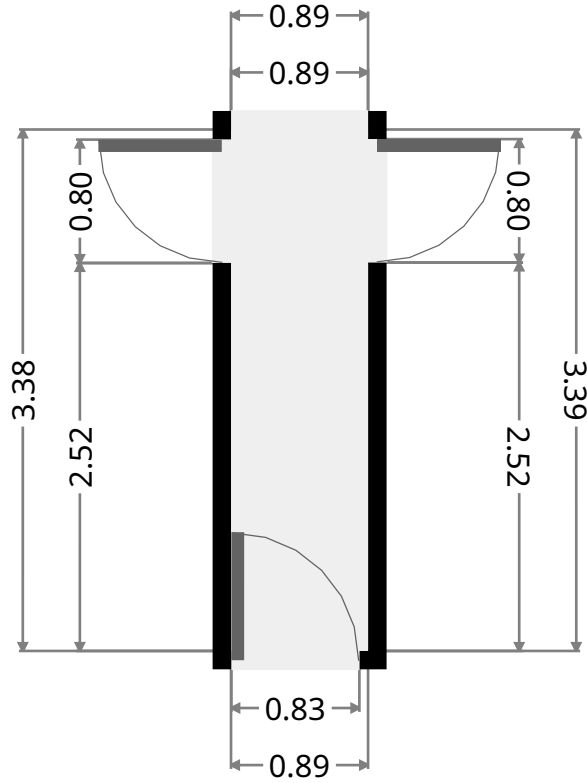
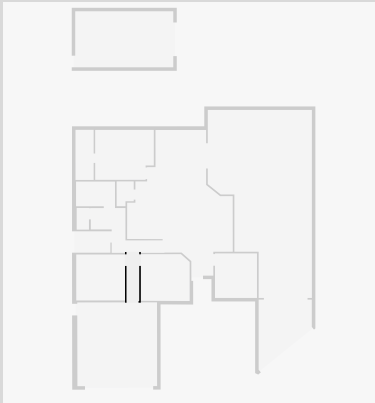

Bedroom

Width: 3.27 m
 Length: 3.50 m
 Area: 11.47 m²
 Perimeter: 13.55 m

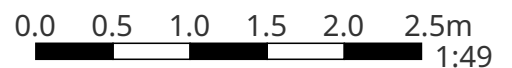
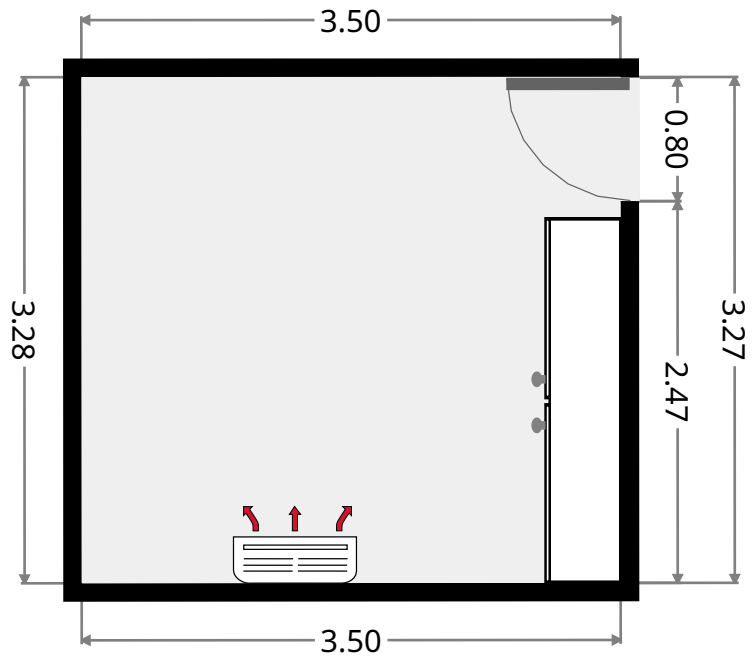
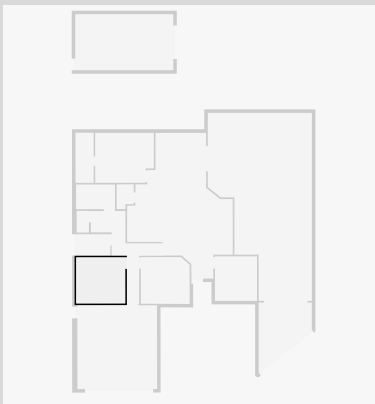

THIS FLOORPLAN IS PROVIDED WITHOUT WARRANTY OF ANY KIND. SENSOPIA DISCLAIMS ANY WARRANTY INCLUDING, WITHOUT LIMITATION, SATISFACTORY QUALITY OR ACCURACY OF DIMENSIONS.

20 Lilydale Close

Bedroom

Width: 3.34 m
 Length: 3.49 m
 Area: 11.46 m²
 Perimeter: 13.30 m

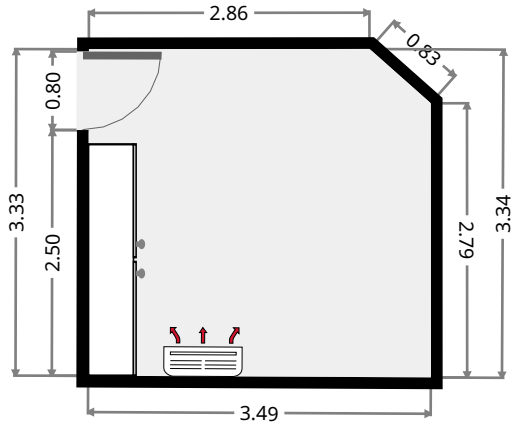
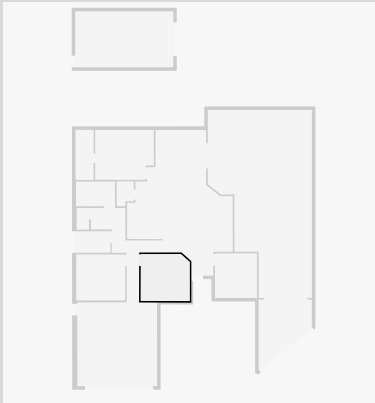

Garage

Width: 5.68 m
 Length: 5.98 m
 Area: 34.04 m²
 Perimeter: 23.34 m

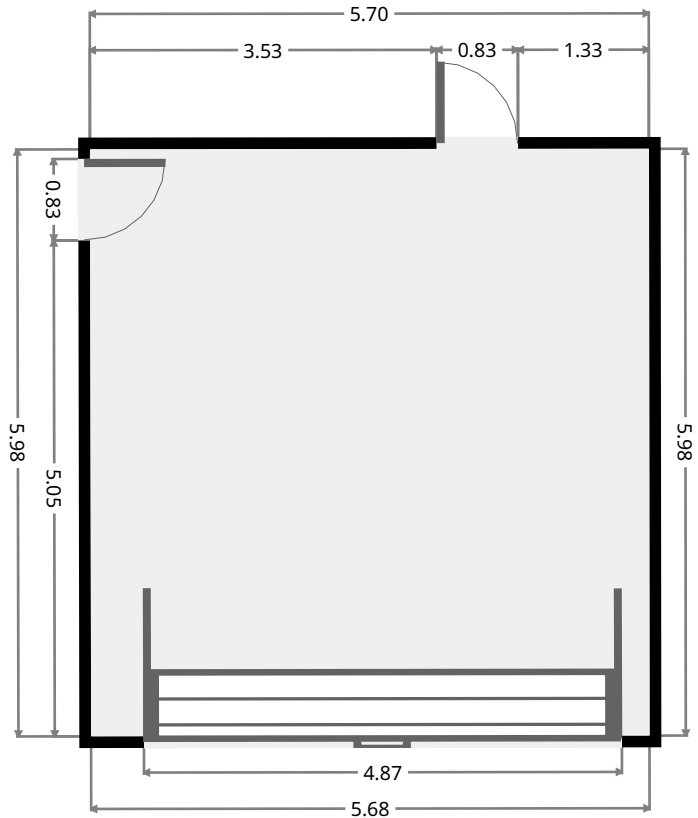
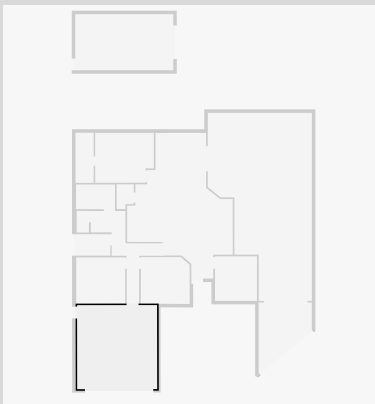

THIS FLOORPLAN IS PROVIDED WITHOUT WARRANTY OF ANY KIND. SENSOPIA DISCLAIMS ANY WARRANTY INCLUDING, WITHOUT LIMITATION, SATISFACTORY QUALITY OR ACCURACY OF DIMENSIONS.

20 Lilydale Close

Outdoor Area

Width: 7.43 m
Length: 13.43 m
Area: 79.70 m²
Perimeter: 41.24 m

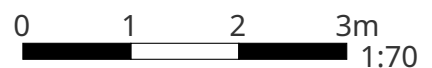
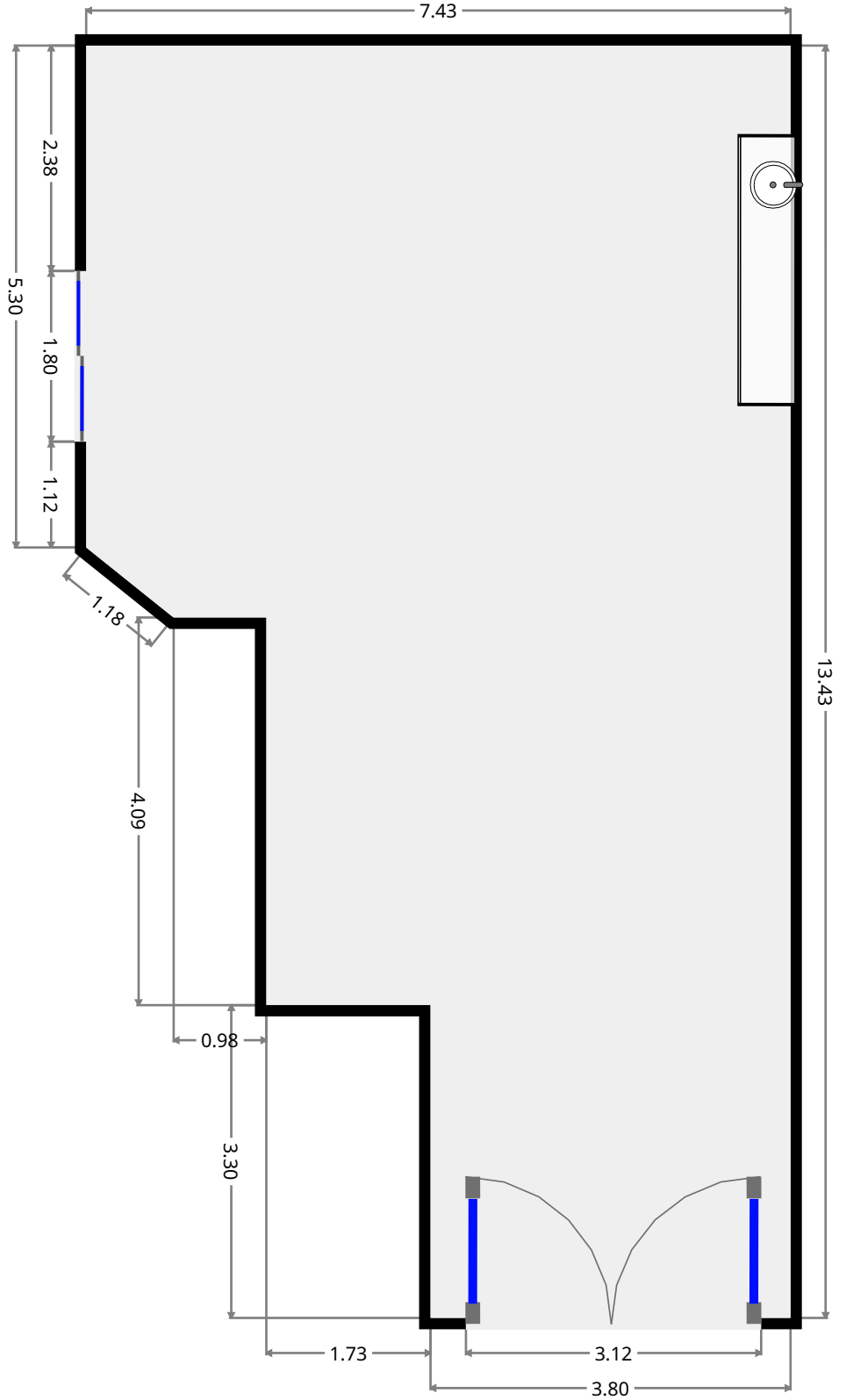
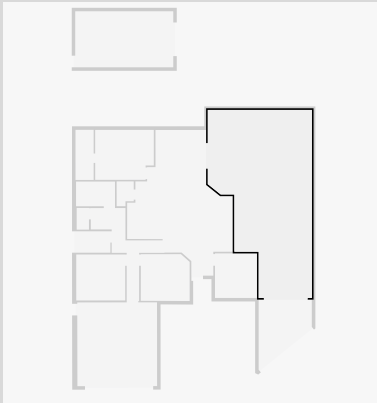

THIS FLOORPLAN IS PROVIDED WITHOUT WARRANTY OF ANY KIND. SENSOPIA DISCLAIMS ANY WARRANTY INCLUDING, WITHOUT LIMITATION, SATISFACTORY QUALITY OR ACCURACY OF DIMENSIONS.

20 Lilydale Close

•
 Width: 3.79 m
 Length: 5.00 m
 Area: 13.17 m²
 Perimeter: 15.61 m

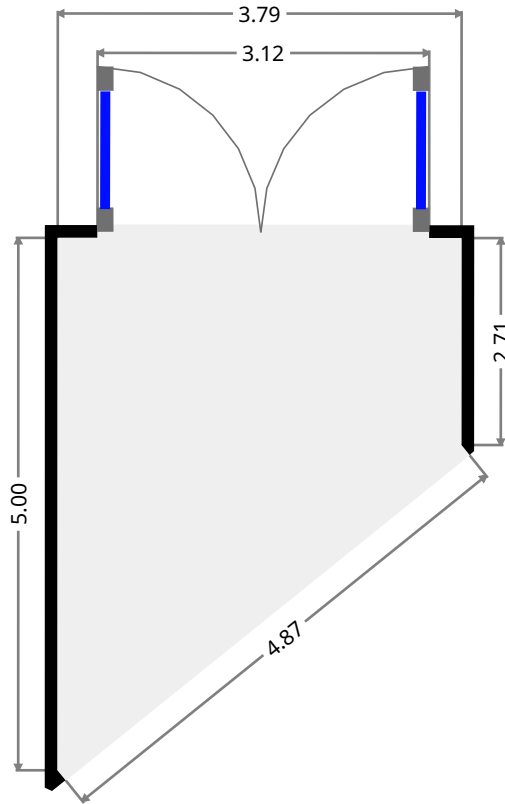
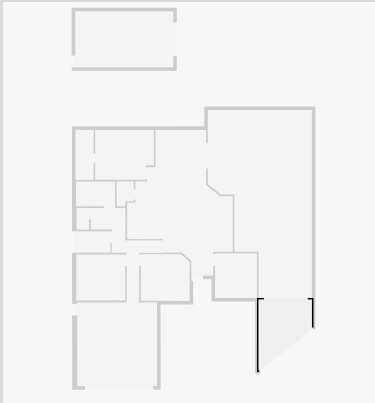

Shed

Width: 4.00 m
 Length: 7.00 m
 Area: 28.00 m²
 Perimeter: 22.00 m

