

# 20 Donovan Crescent

**SUBMITTED BY**

Ray White Rockhampton Casey  
stockers@cqoz.com

---

**CREATED ON**

2022-07-12

---

**Floors**

1

---

## ▼ Ground Floor



▼ Bathroom  
Ground Floor

WIDTH: 2.09 m • LENGTH: 1.80 m  
AREA: 3.76 m<sup>2</sup> • PERIMETER: 7.78 m

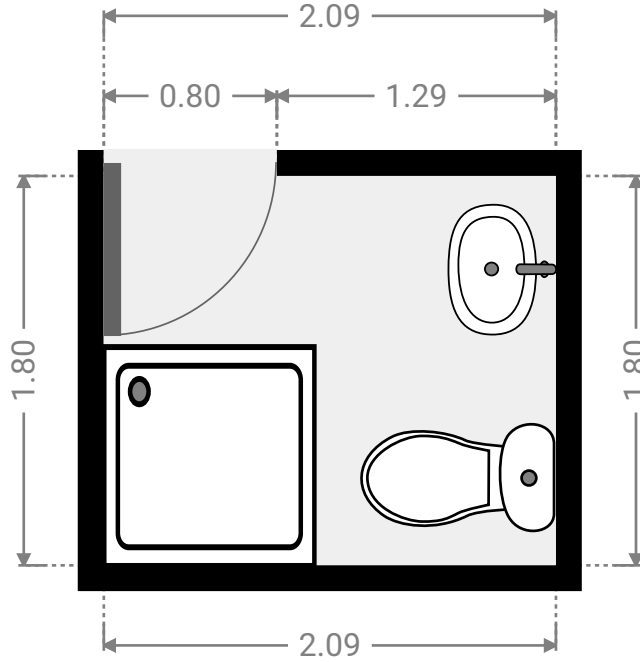
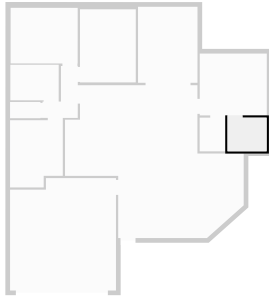

▼ Bathroom  
Ground Floor

WIDTH: 2.58 m • LENGTH: 1.90 m  
AREA: 4.90 m<sup>2</sup> • PERIMETER: 8.96 m

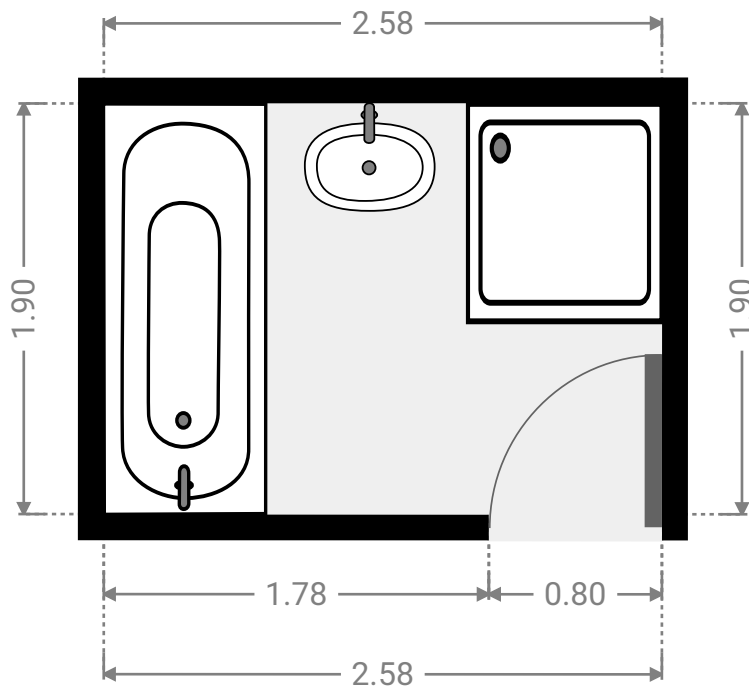
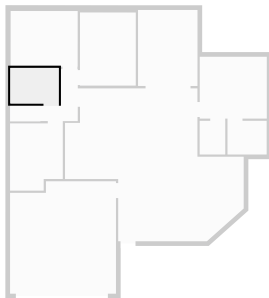

FLOORS: 1

▼ **Bedroom**  
Ground Floor

WIDTH: 2.82 m • LENGTH: 3.59 m  
AREA: 9.47 m<sup>2</sup> • PERIMETER: 12.81 m

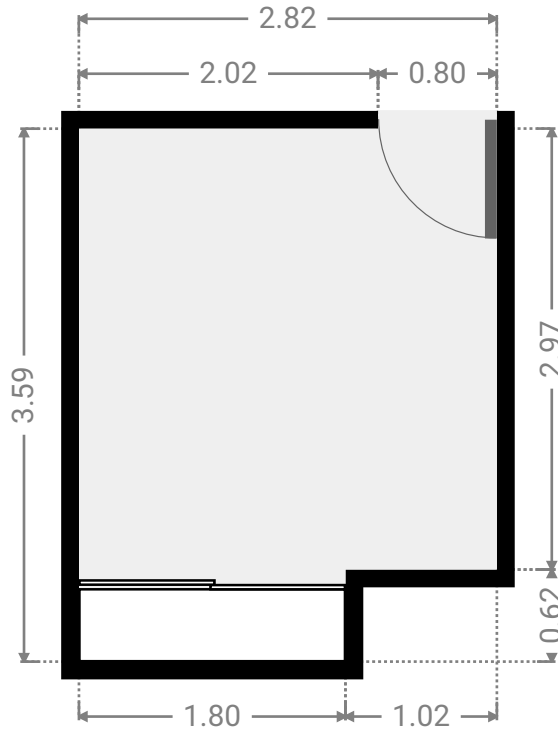
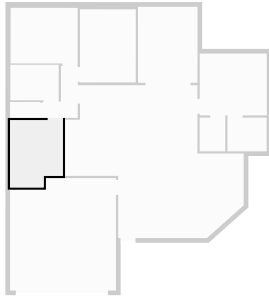

▼ **Bedroom**  
Ground Floor

WIDTH: 3.58 m • LENGTH: 2.97 m  
AREA: 10.63 m<sup>2</sup> • PERIMETER: 13.10 m

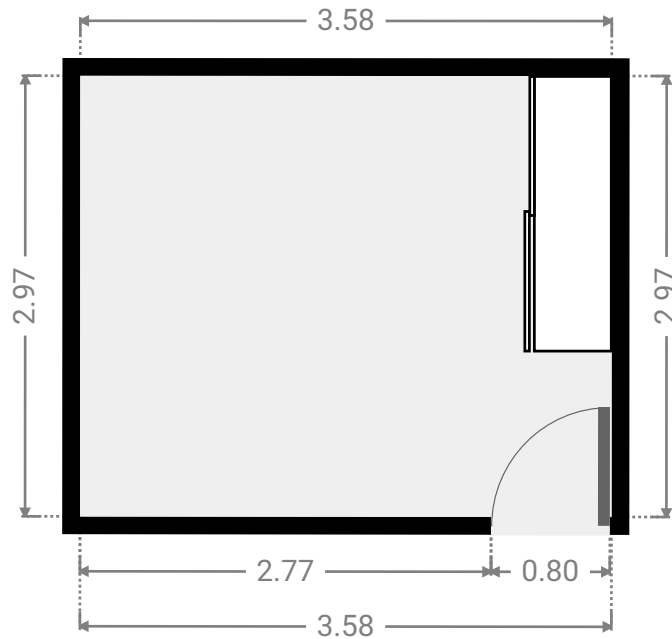
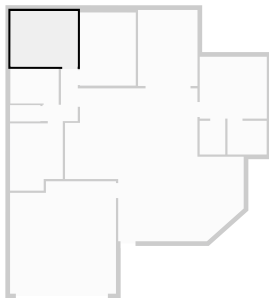

FLOORS: 1

▼ **Bedroom**  
Ground Floor

WIDTH: 2.98 m • LENGTH: 3.90 m  
AREA: 11.63 m<sup>2</sup> • PERIMETER: 13.76 m

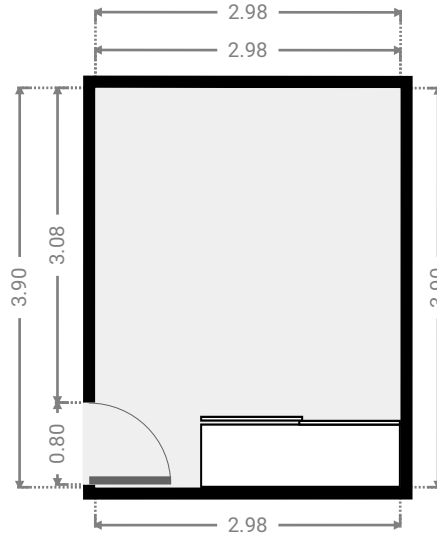
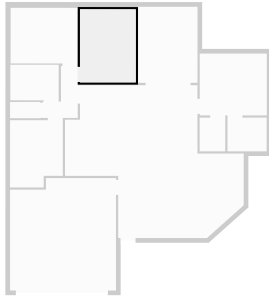

▼ **Garage**  
Ground Floor

WIDTH: 5.65 m • LENGTH: 6.00 m  
AREA: 32.74 m<sup>2</sup> • PERIMETER: 23.31 m

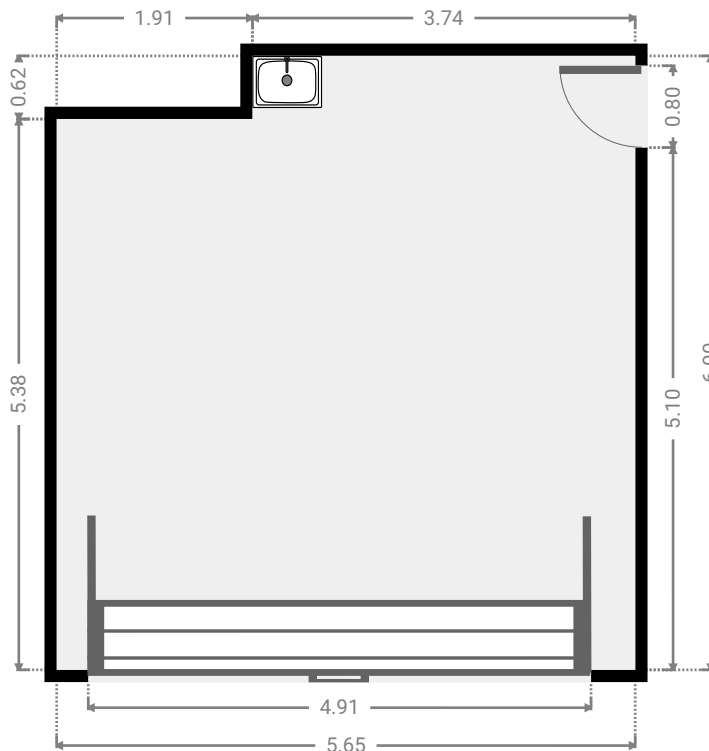
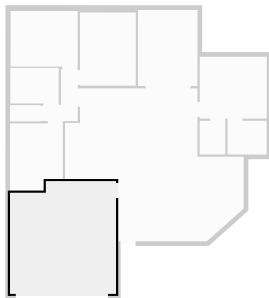

FLOORS: 1

▼ **Hall**  
Ground Floor

WIDTH: 1.88 m • LENGTH: 2.78 m  
AREA: 3.35 m<sup>2</sup> • PERIMETER: 9.31 m

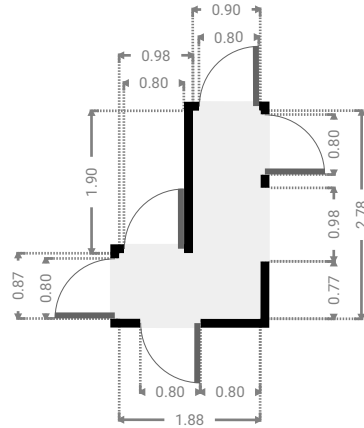
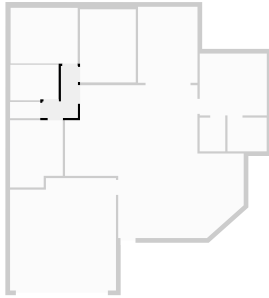

▼ **Living Room**  
Ground Floor

WIDTH: 9.54 m • LENGTH: 8.16 m  
AREA: 56.22 m<sup>2</sup> • PERIMETER: 34.32 m

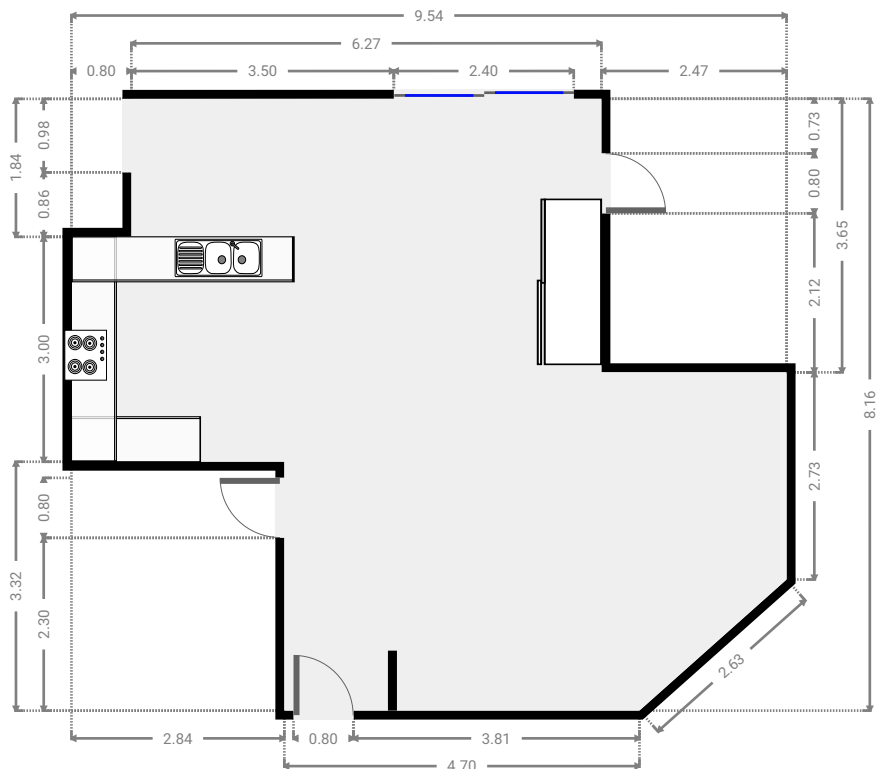
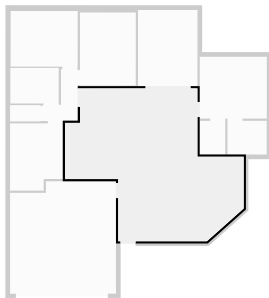

FLOORS: 1

▼ **Other**  
Ground Floor

WIDTH: 3.18 m • LENGTH: 4.06 m  
AREA: 12.88 m<sup>2</sup> • PERIMETER: 14.46 m

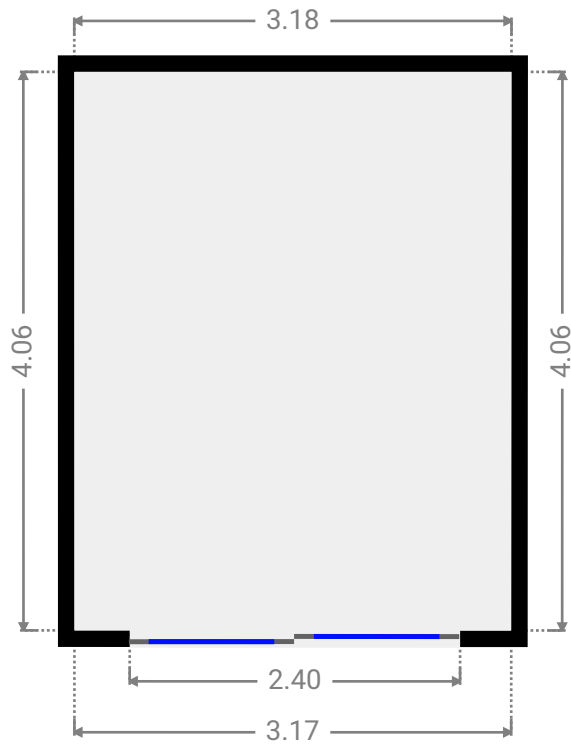
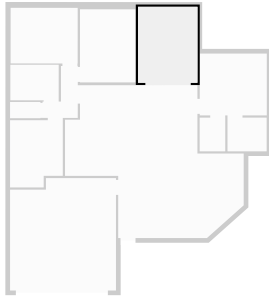

▼ **Primary Bedroom**  
Ground Floor

WIDTH: 3.58 m • LENGTH: 3.30 m  
AREA: 11.81 m<sup>2</sup> • PERIMETER: 13.76 m

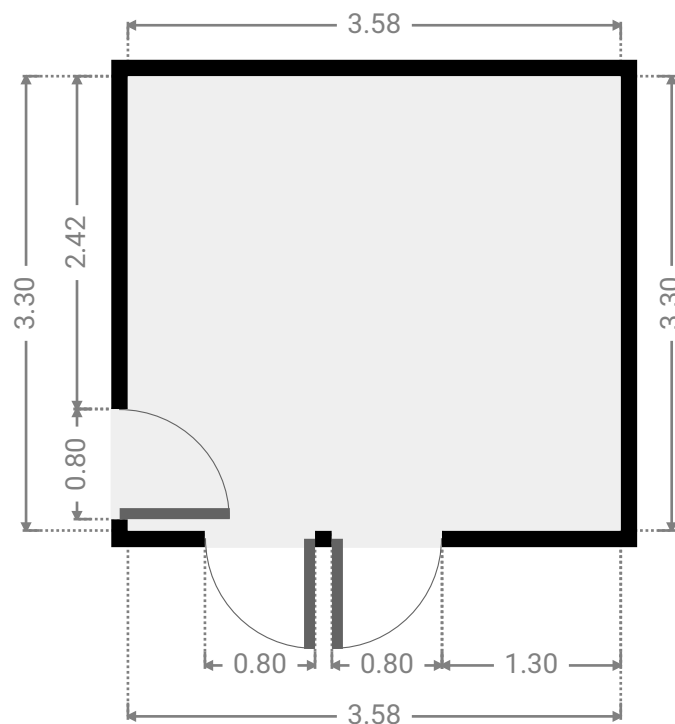
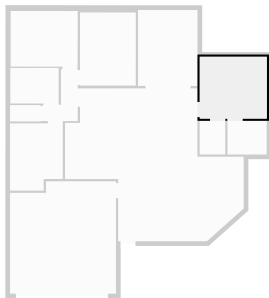

FLOORS: 1

▼ **Closet**  
Ground Floor

WIDTH: 1.37 m • LENGTH: 1.80 m  
AREA: 2.46 m<sup>2</sup> • PERIMETER: 6.33 m

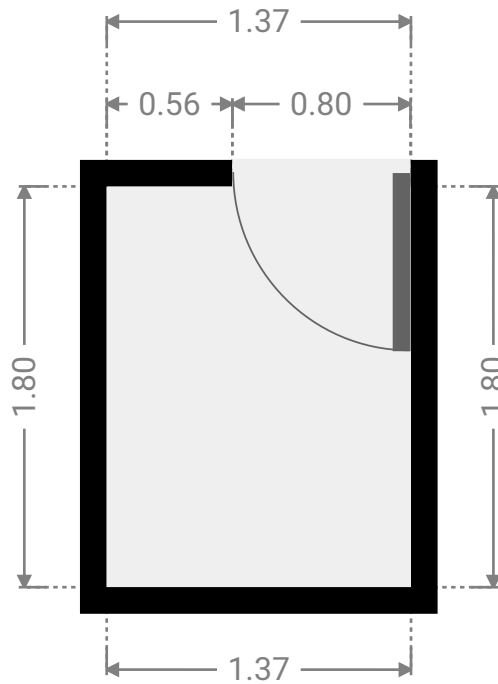
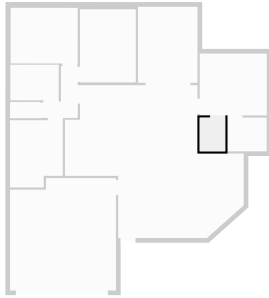

▼ **Toilet**  
Ground Floor

WIDTH: 1.62 m • LENGTH: 0.87 m  
AREA: 1.41 m<sup>2</sup> • PERIMETER: 4.98 m

