

# 3 Thomas Street

## Ground Floor

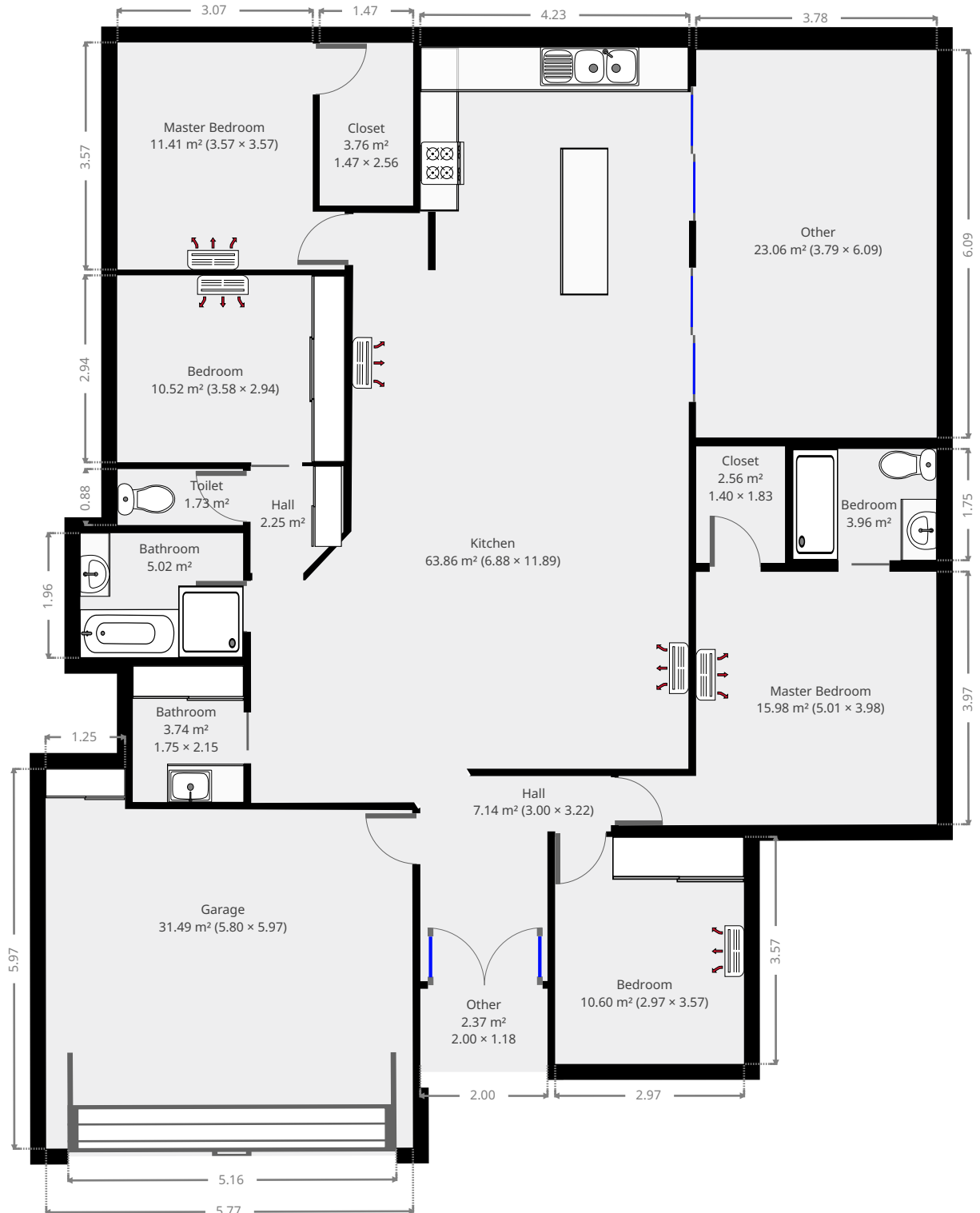

THIS FLOORPLAN IS PROVIDED WITHOUT WARRANTY OF ANY KIND. SENSOPIA DISCLAIMS ANY WARRANTY INCLUDING, WITHOUT LIMITATION, SATISFACTORY QUALITY OR ACCURACY OF DIMENSIONS.

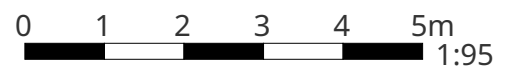

### 3 Thomas Street

#### Hall

Width: 3.00 m  
 Length: 3.22 m  
 Area: 7.14 m<sup>2</sup>  
 Perimeter: 12.11 m

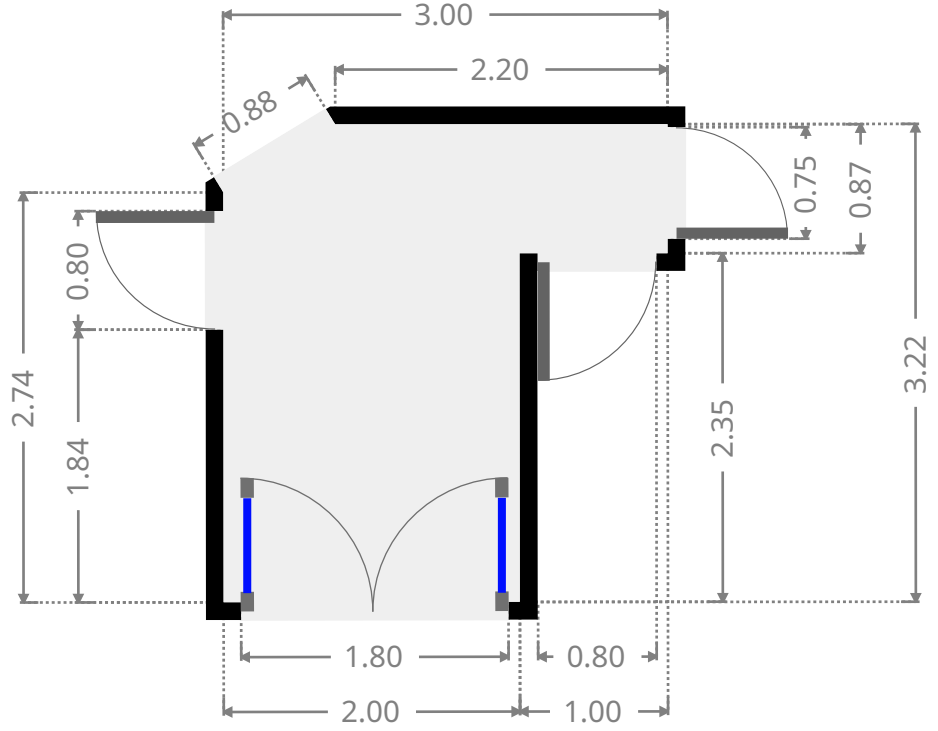
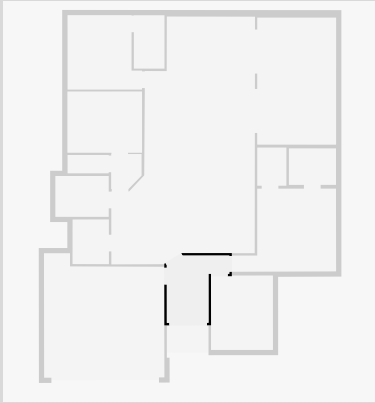

#### Bedroom

Width: 2.97 m  
 Length: 3.57 m  
 Area: 10.60 m<sup>2</sup>  
 Perimeter: 13.08 m

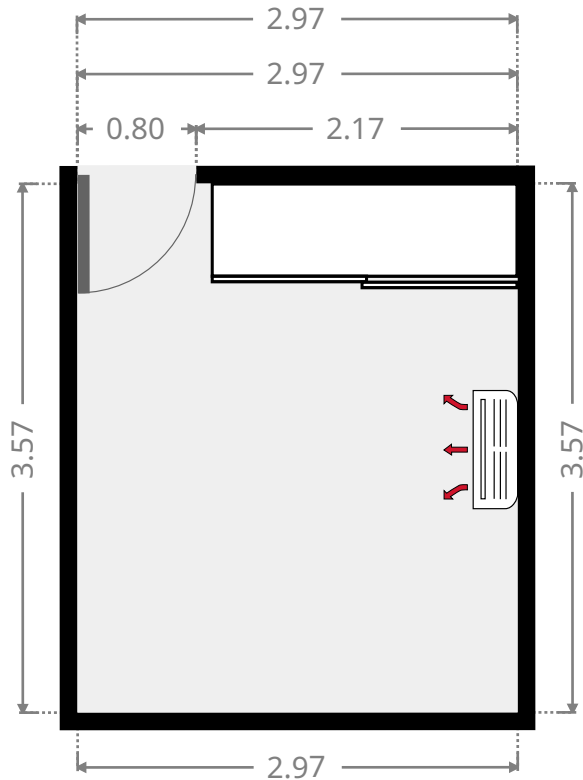
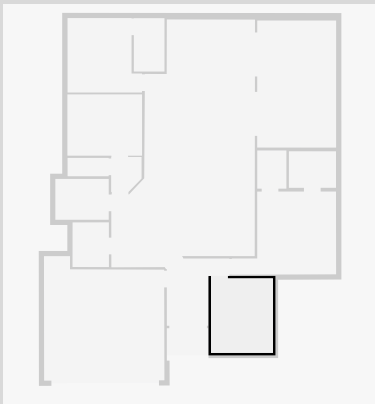

THIS FLOORPLAN IS PROVIDED WITHOUT WARRANTY OF ANY KIND. SENSOPIA DISCLAIMS ANY WARRANTY INCLUDING, WITHOUT LIMITATION, SATISFACTORY QUALITY OR ACCURACY OF DIMENSIONS.

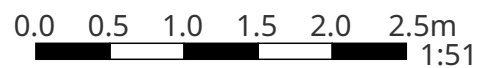

# 3 Thomas Street

## Master Bedroom

Width: 3.98 m  
 Length: 5.01 m  
 Area: 15.98 m<sup>2</sup>  
 Perimeter: 17.96 m

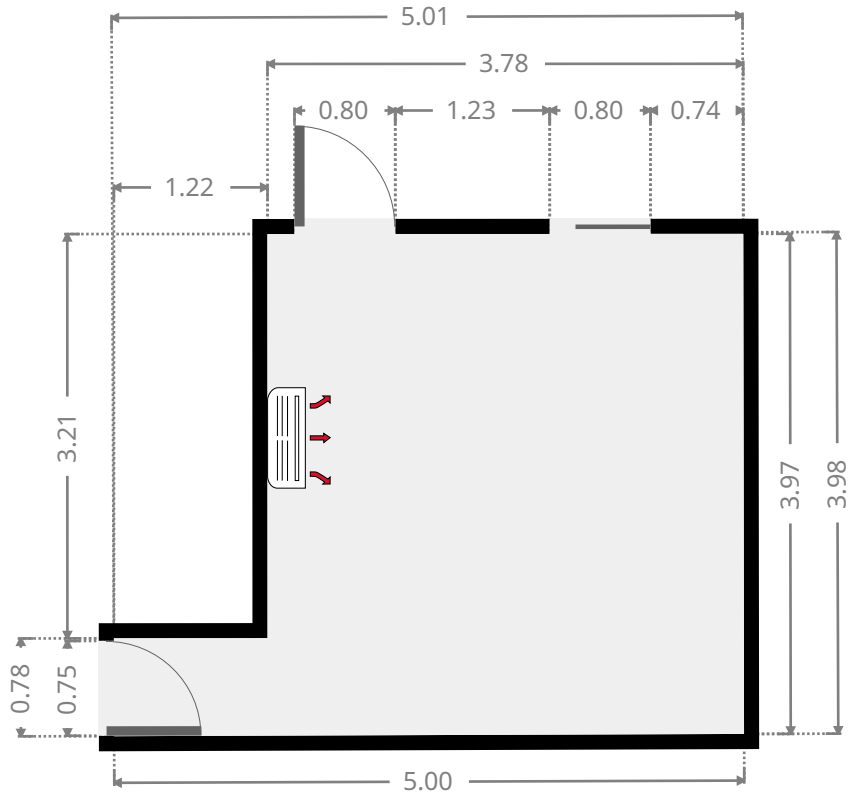
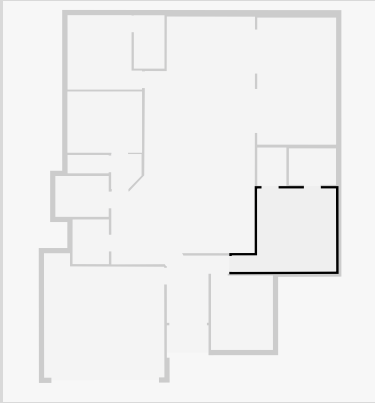

## Bedroom

Width: 1.75 m  
 Length: 2.26 m  
 Area: 3.96 m<sup>2</sup>  
 Perimeter: 8.02 m

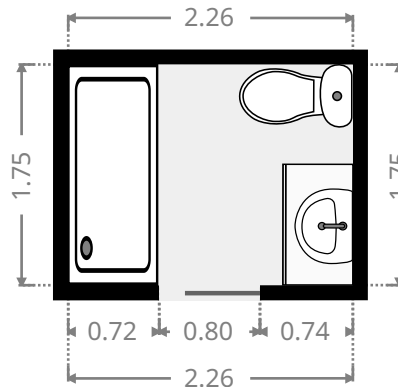
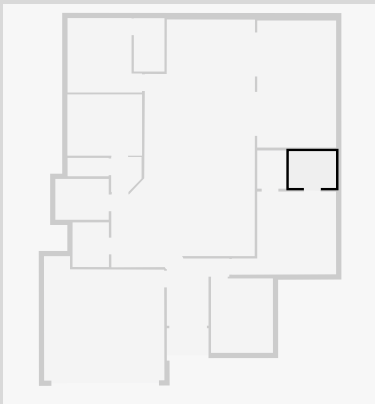

THIS FLOORPLAN IS PROVIDED WITHOUT WARRANTY OF ANY KIND. SENSOPIA DISCLAIMS ANY WARRANTY INCLUDING, WITHOUT LIMITATION, SATISFACTORY QUALITY OR ACCURACY OF DIMENSIONS.

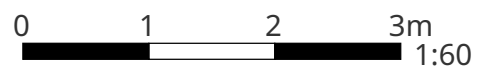

# 3 Thomas Street

## Closet

Width: 1.40 m  
 Length: 1.83 m  
 Area: 2.56 m<sup>2</sup>  
 Perimeter: 6.46 m

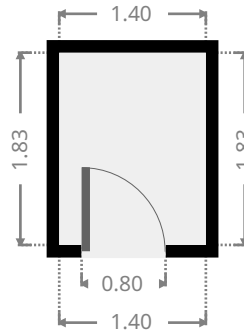
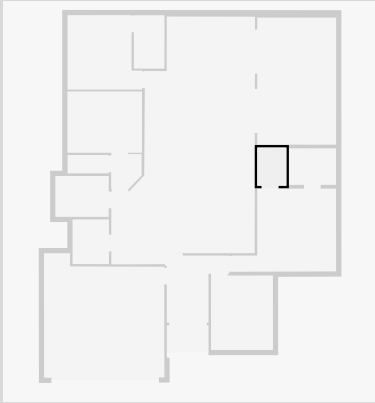

## Garage

Width: 5.80 m  
 Length: 5.97 m  
 Area: 31.49 m<sup>2</sup>  
 Perimeter: 23.44 m

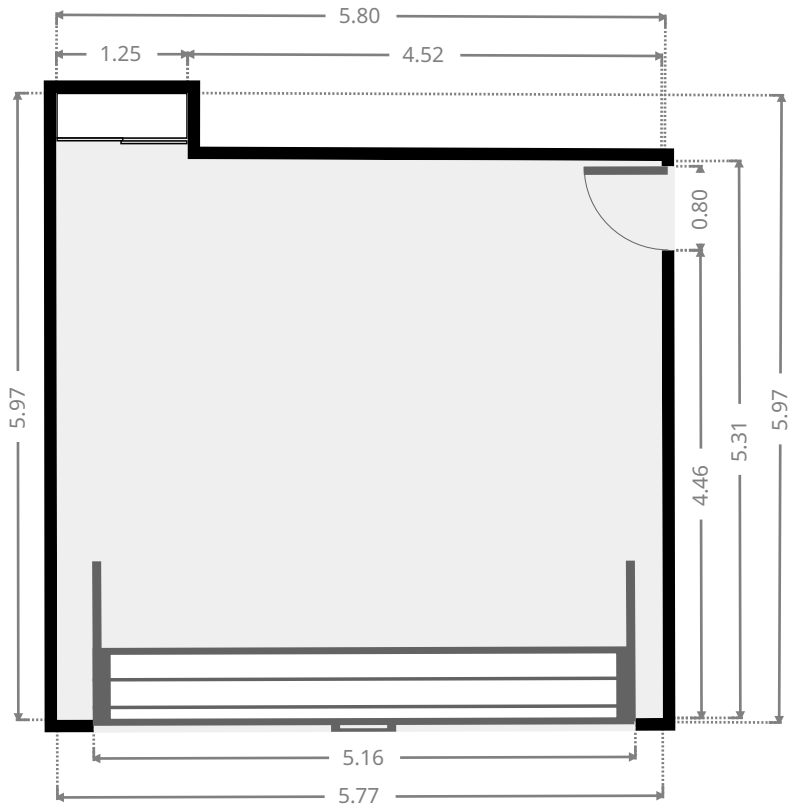
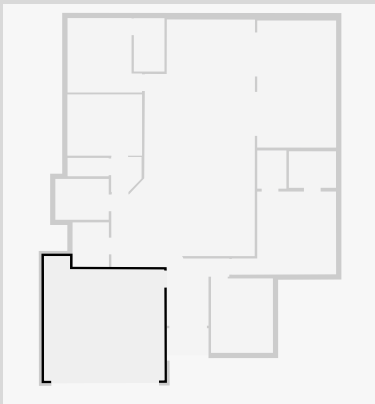

THIS FLOORPLAN IS PROVIDED WITHOUT WARRANTY OF ANY KIND. SENSOPIA DISCLAIMS ANY WARRANTY INCLUDING, WITHOUT LIMITATION, SATISFACTORY QUALITY OR ACCURACY OF DIMENSIONS.



# 3 Thomas Street

## Kitchen

Width: 6.88 m  
 Length: 11.89 m  
 Area: 63.86 m<sup>2</sup>  
 Perimeter: 36.69 m

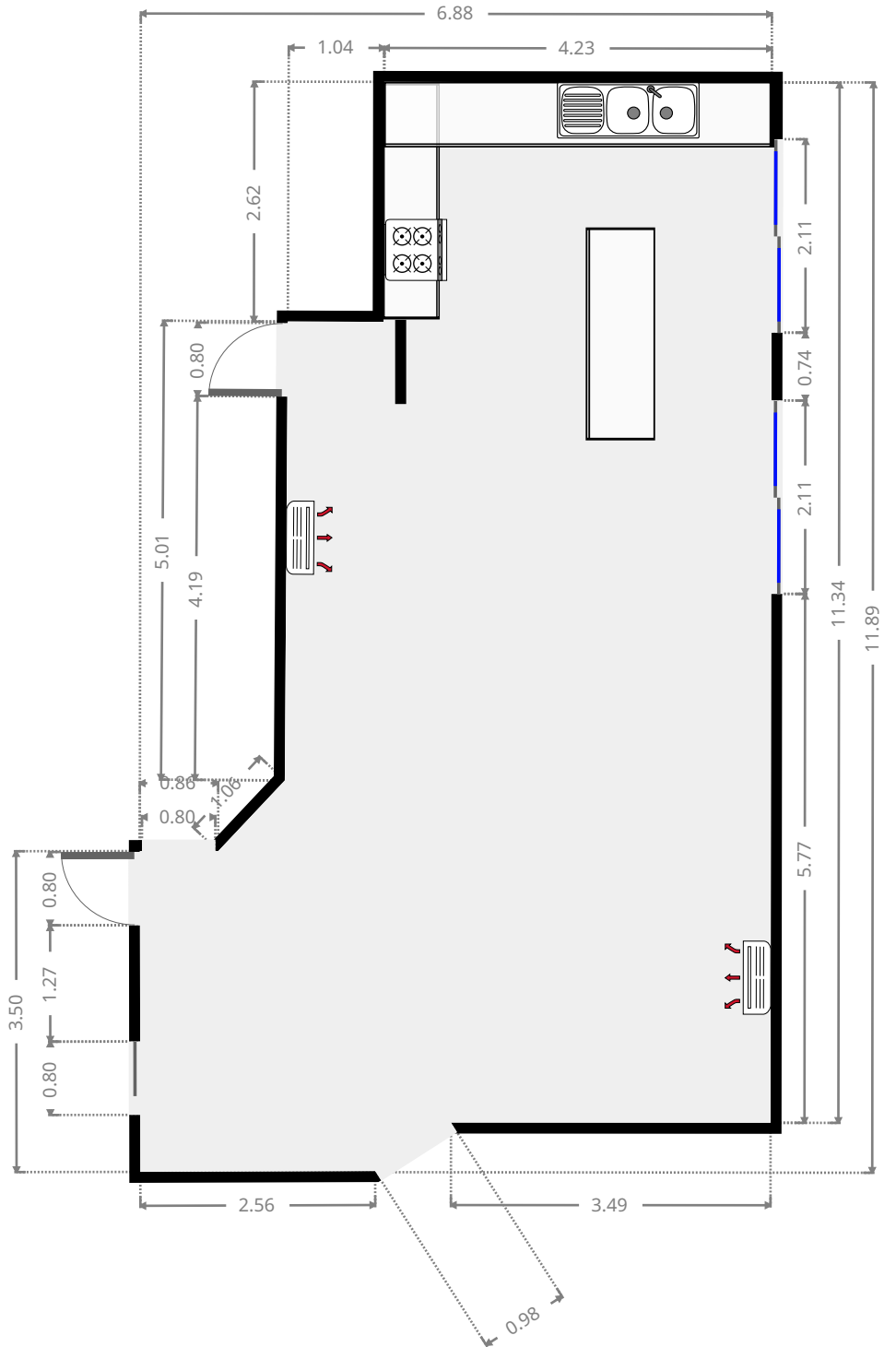
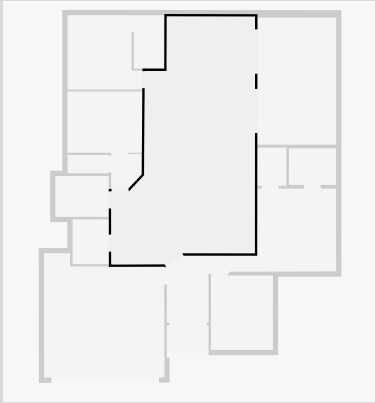

THIS FLOORPLAN IS PROVIDED WITHOUT WARRANTY OF ANY KIND. SENSOPIA DISCLAIMS ANY WARRANTY INCLUDING, WITHOUT LIMITATION, SATISFACTORY QUALITY OR ACCURACY OF DIMENSIONS.



# 3 Thomas Street

## Master Bedroom

Width: 3.57 m  
 Length: 3.57 m  
 Area: 11.41 m<sup>2</sup>  
 Perimeter: 14.28 m

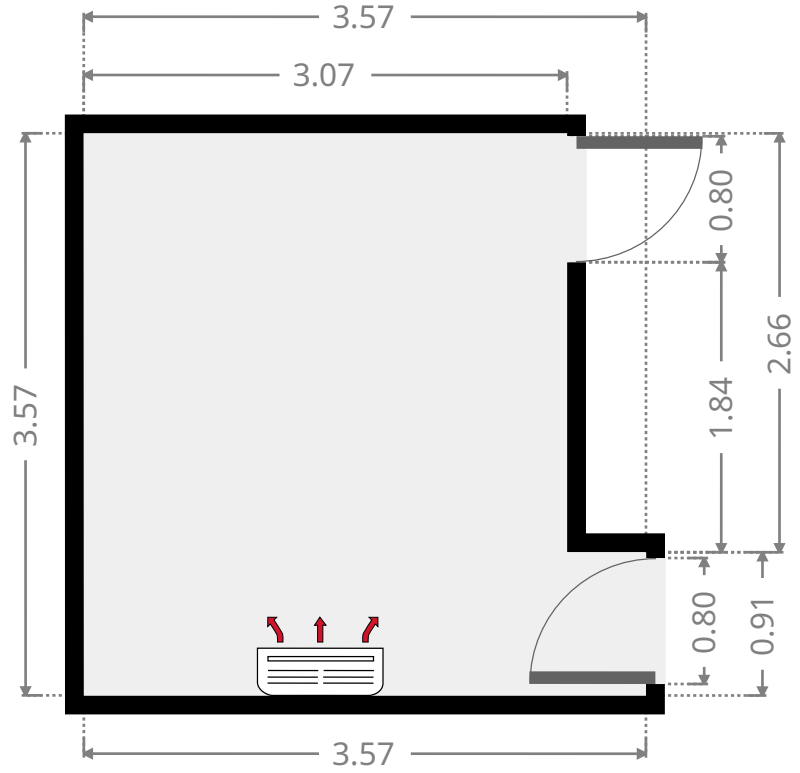
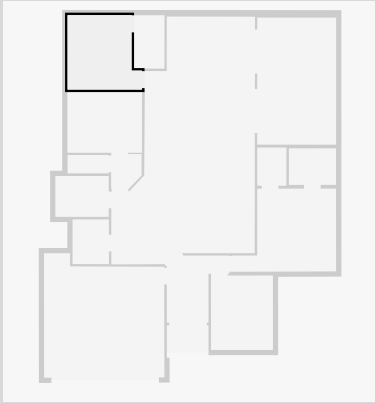

## Closet

Width: 1.47 m  
 Length: 2.56 m  
 Area: 3.76 m<sup>2</sup>  
 Perimeter: 8.06 m

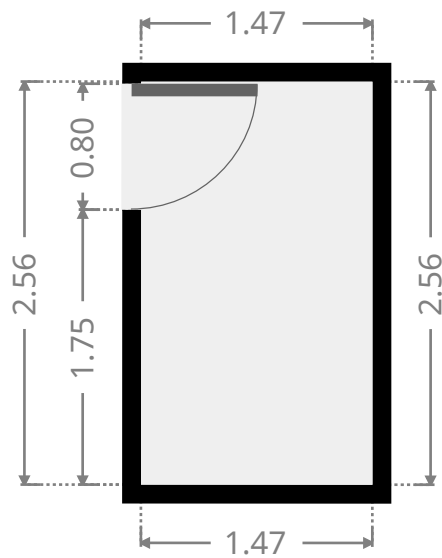
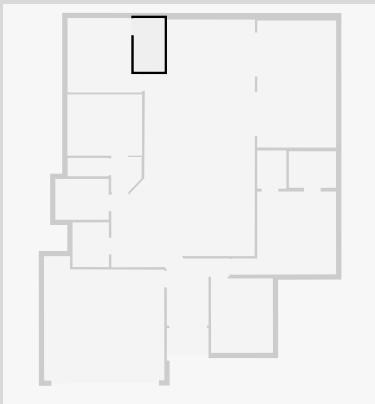

THIS FLOORPLAN IS PROVIDED WITHOUT WARRANTY OF ANY KIND. SENSOPIA DISCLAIMS ANY WARRANTY INCLUDING, WITHOUT LIMITATION, SATISFACTORY QUALITY OR ACCURACY OF DIMENSIONS.

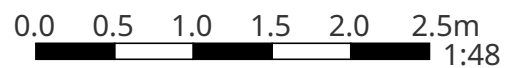

# 3 Thomas Street

## Other

Width: 3.79 m  
Length: 6.09 m  
Area: 23.06 m<sup>2</sup>  
Perimeter: 19.76 m

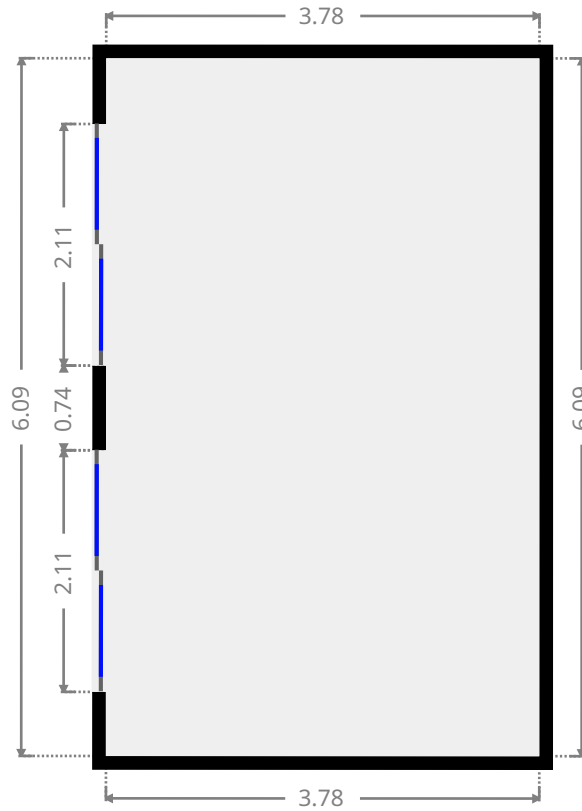
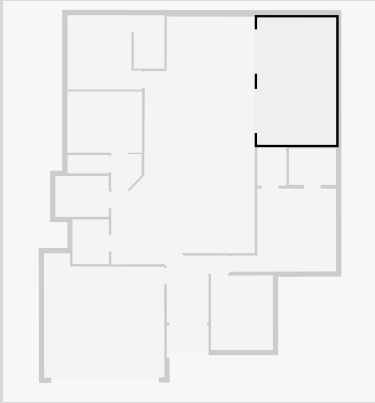

## Bedroom

Width: 2.94 m  
Length: 3.58 m  
Area: 10.52 m<sup>2</sup>  
Perimeter: 13.04 m

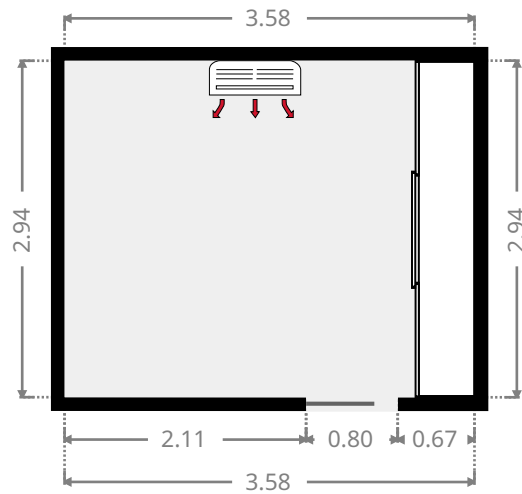
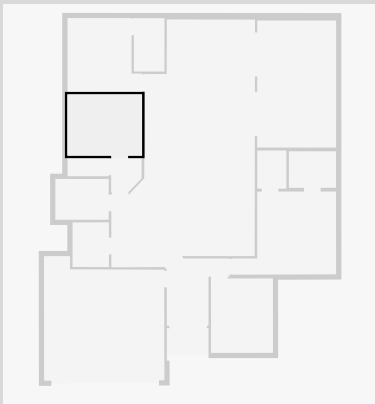

### 3 Thomas Street

#### Toilet / Half Bath

Width: 0.88 m  
Length: 1.97 m  
Area: 1.73 m<sup>2</sup>  
Perimeter: 5.70 m

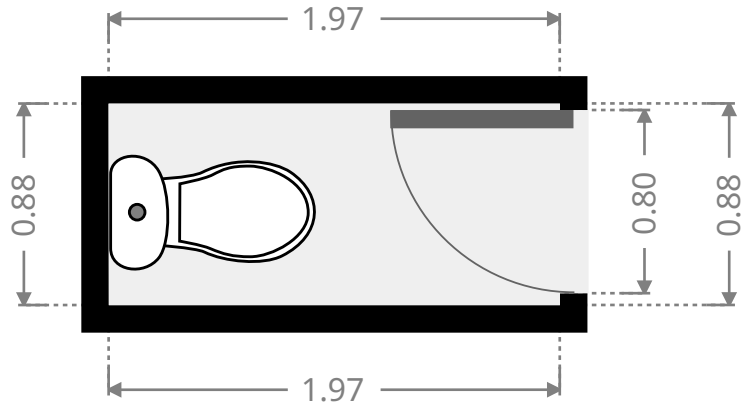
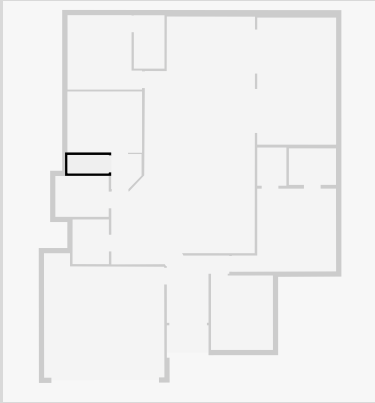

#### Bathroom

Width: 1.96 m  
Length: 2.56 m  
Area: 5.02 m<sup>2</sup>  
Perimeter: 9.04 m

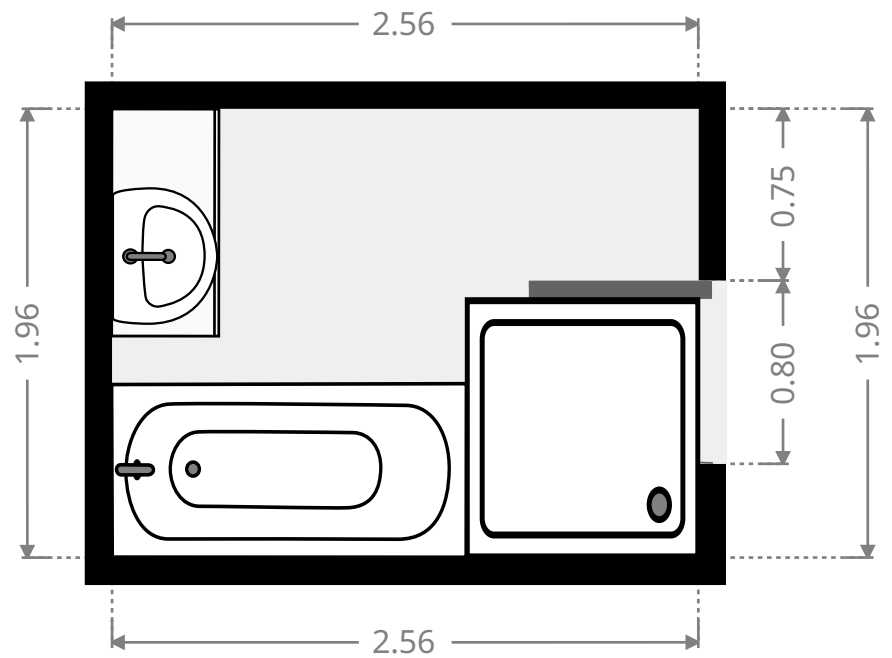
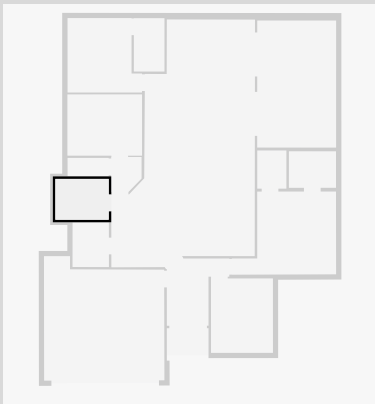

THIS FLOORPLAN IS PROVIDED WITHOUT WARRANTY OF ANY KIND. SENSOPIA DISCLAIMS ANY WARRANTY INCLUDING, WITHOUT LIMITATION, SATISFACTORY QUALITY OR ACCURACY OF DIMENSIONS.

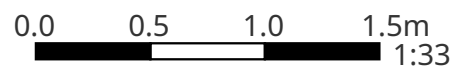



### 3 Thomas Street

#### Hall

Width: 1.46 m  
 Length: 1.68 m  
 Area: 2.25 m<sup>2</sup>  
 Perimeter: 5.90 m

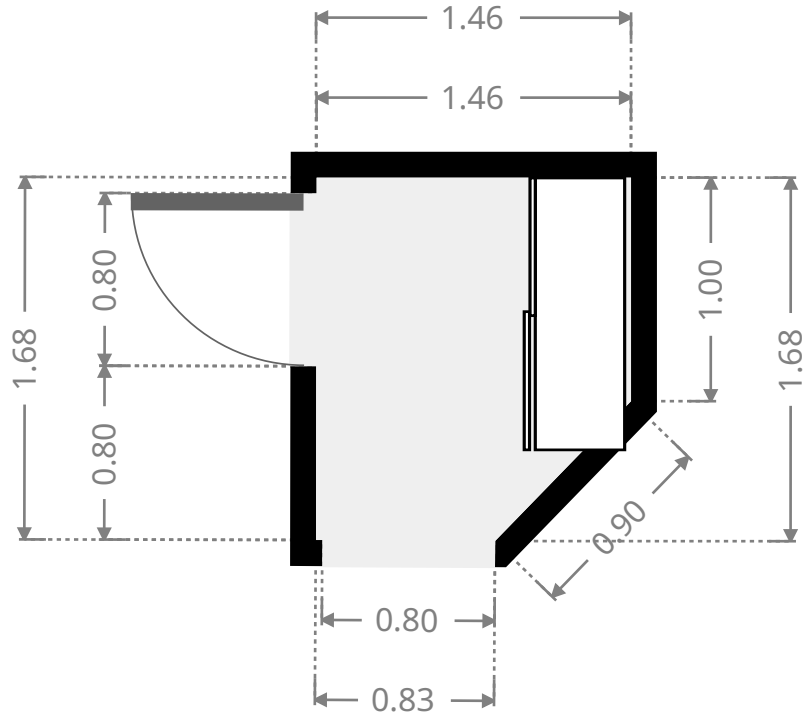
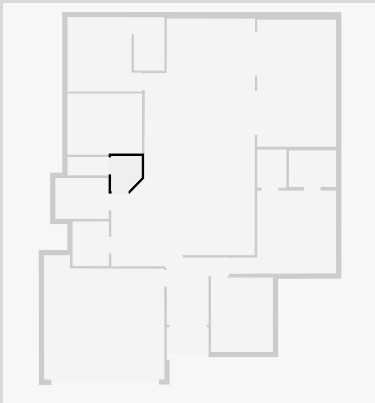

#### Bathroom

Width: 1.75 m  
 Length: 2.15 m  
 Area: 3.74 m<sup>2</sup>  
 Perimeter: 7.77 m

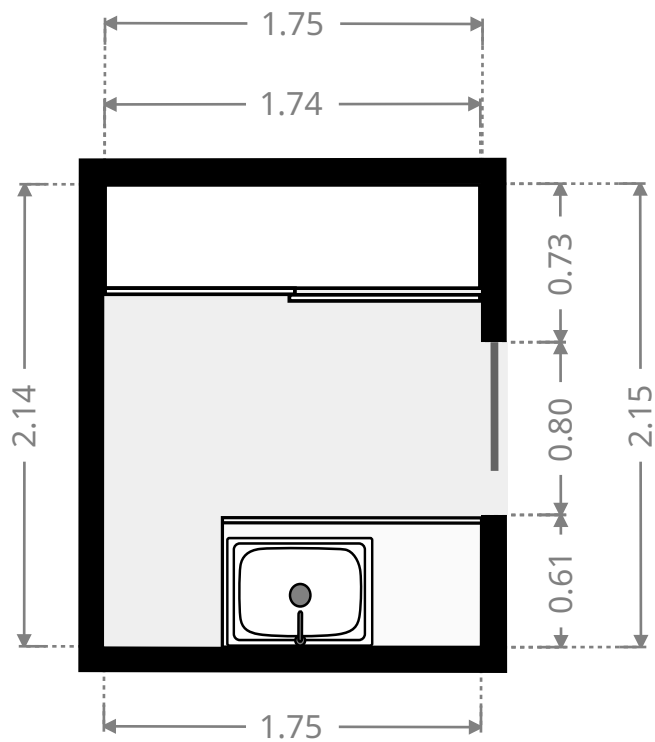
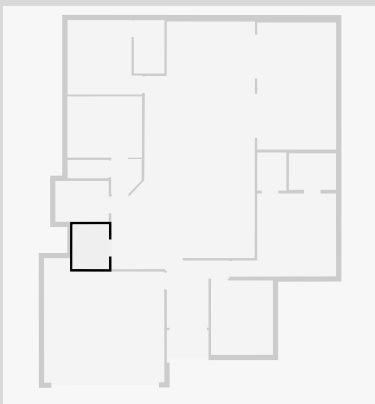

THIS FLOORPLAN IS PROVIDED WITHOUT WARRANTY OF ANY KIND. SENSOPIA DISCLAIMS ANY WARRANTY INCLUDING, WITHOUT LIMITATION, SATISFACTORY QUALITY OR ACCURACY OF DIMENSIONS.

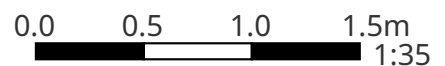

# 3 Thomas Street

## Other

Width: 1.18 m  
Length: 2.00 m  
Area: 2.37 m<sup>2</sup>  
Perimeter: 6.37 m

