

2 Scully Street

Created on
2020-12-22

Floors
1

▼ Ground Floor

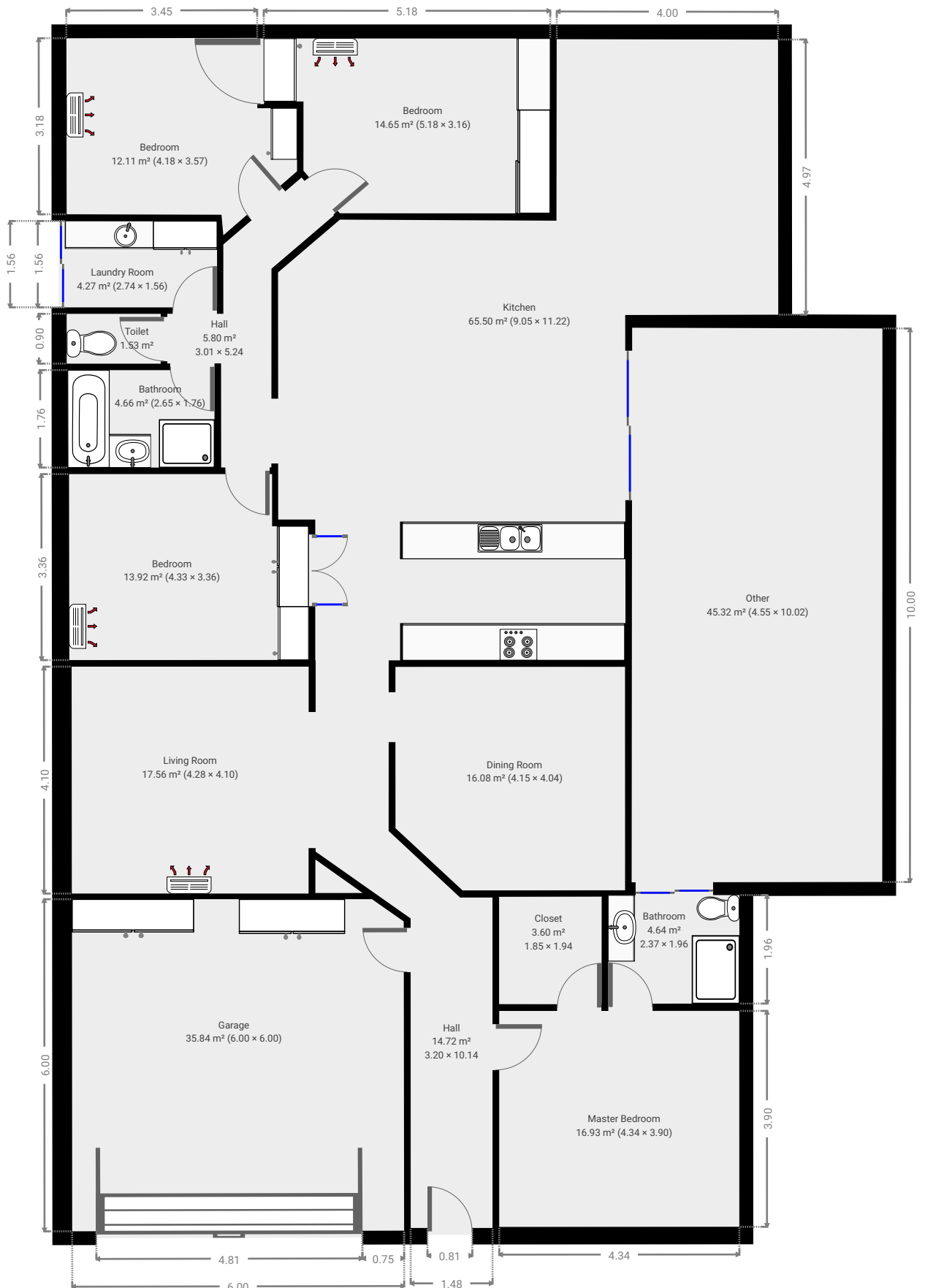

▼ Hall Ground Floor

WIDTH:3.20 m · LENGTH:10.14 m
AREA:14.72 m² · PERIMETER:25.11 m

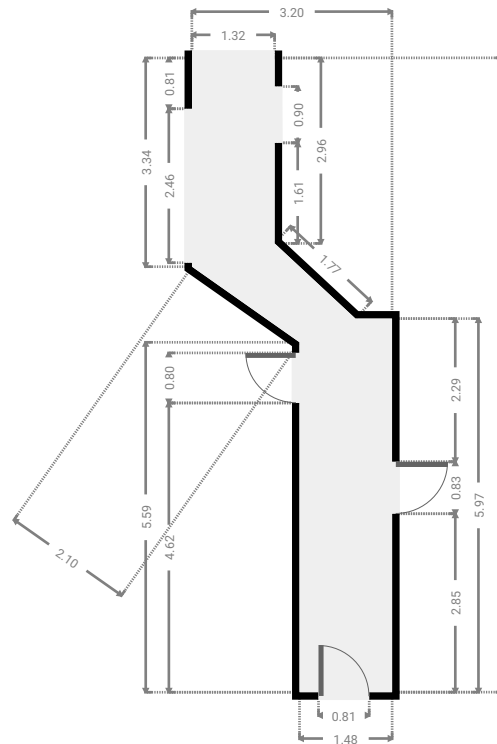
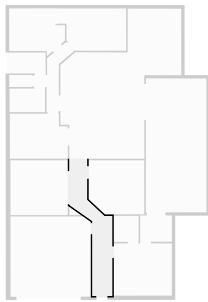

▼ Master Bedroom Ground Floor

WIDTH:4.34 m · LENGTH:3.90 m
AREA:16.93 m² · PERIMETER:16.48 m

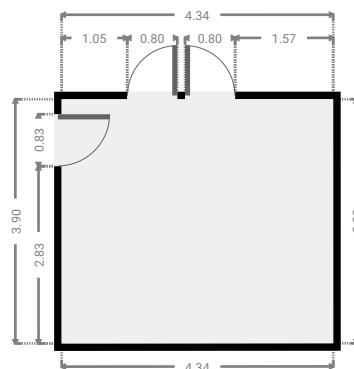
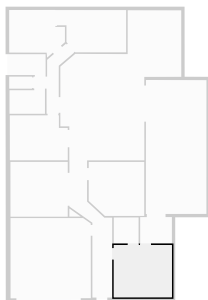

▼ **Bathroom**
Ground Floor

WIDTH:2.37 m · LENGTH:1.96 m
AREA:4.64 m² · PERIMETER:8.66 m

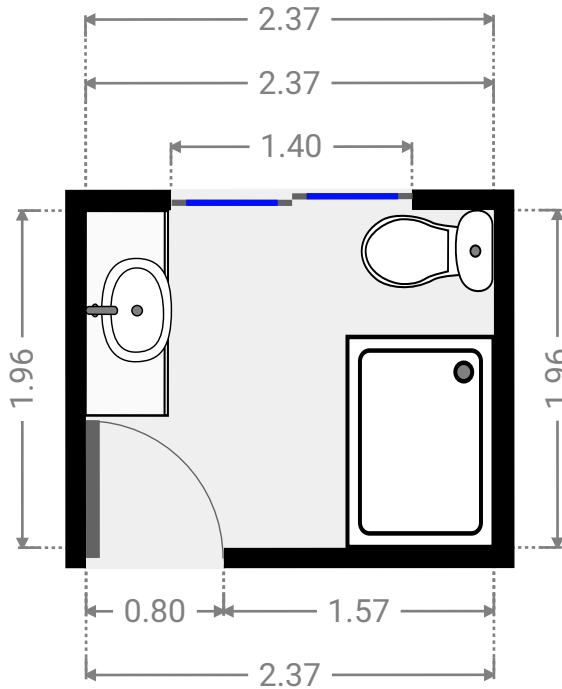
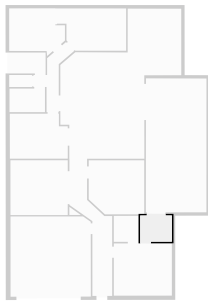

▼ **Closet**
Ground Floor

WIDTH:1.85 m · LENGTH:1.94 m
AREA:3.60 m² · PERIMETER:7.59 m

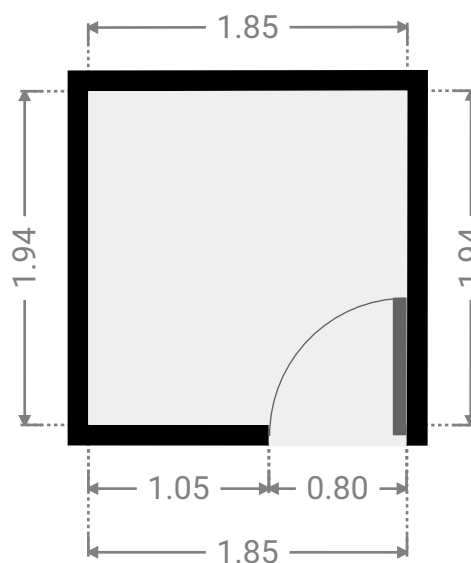
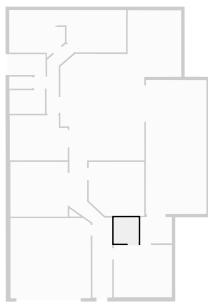

▼ **Garage**
Ground Floor

WIDTH:6.00 m · LENGTH:6.00 m
AREA:35.84 m² · PERIMETER:23.71 m

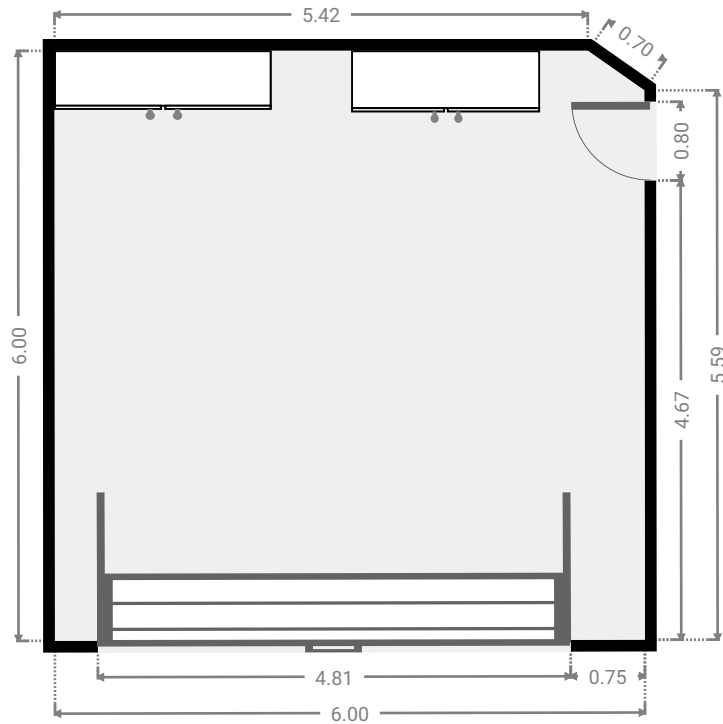
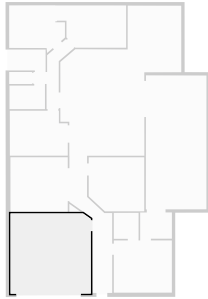

▼ **Living Room**
Ground Floor

WIDTH:4.28 m · LENGTH:4.10 m
AREA:17.56 m² · PERIMETER:16.76 m

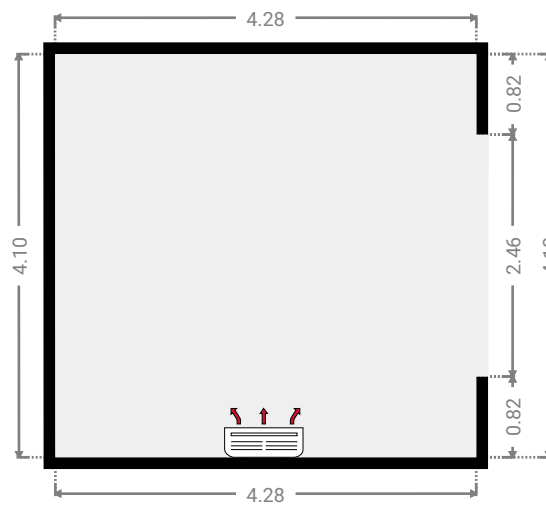
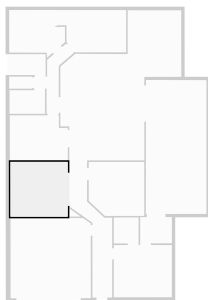

▼ Dining Room Ground Floor

WIDTH:4.15 m · LENGTH:4.04 m
AREA:16.08 m² · PERIMETER:15.69 m

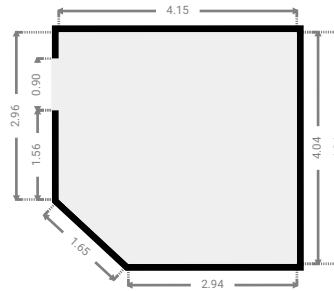
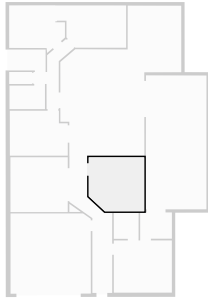

▼ Kitchen Ground Floor

WIDTH:9.05 m · LENGTH:11.22 m
AREA:65.50 m² · PERIMETER:39.93 m

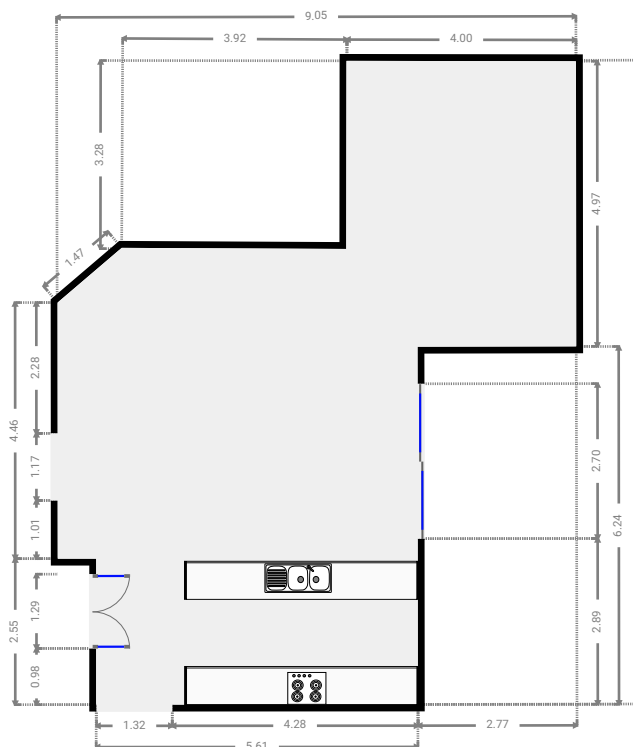
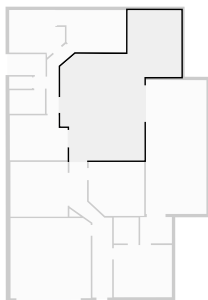

▼ Bedroom

Ground Floor

WIDTH:4.33 m · LENGTH:3.36 m
 AREA:13.92 m² · PERIMETER:15.38 m

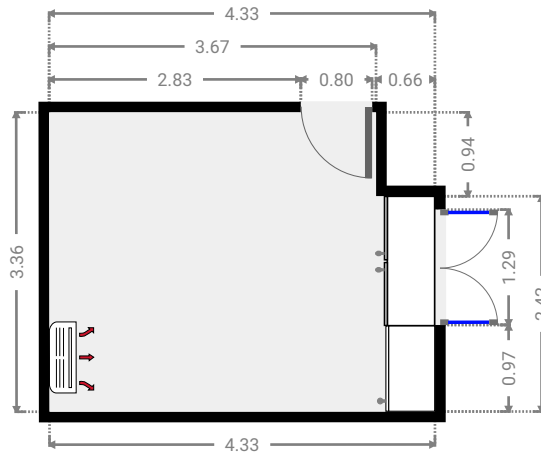
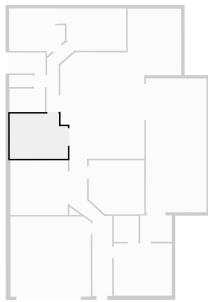

▼ Hall

Ground Floor

WIDTH:3.01 m · LENGTH:5.24 m
 AREA:5.80 m² · PERIMETER:14.76 m

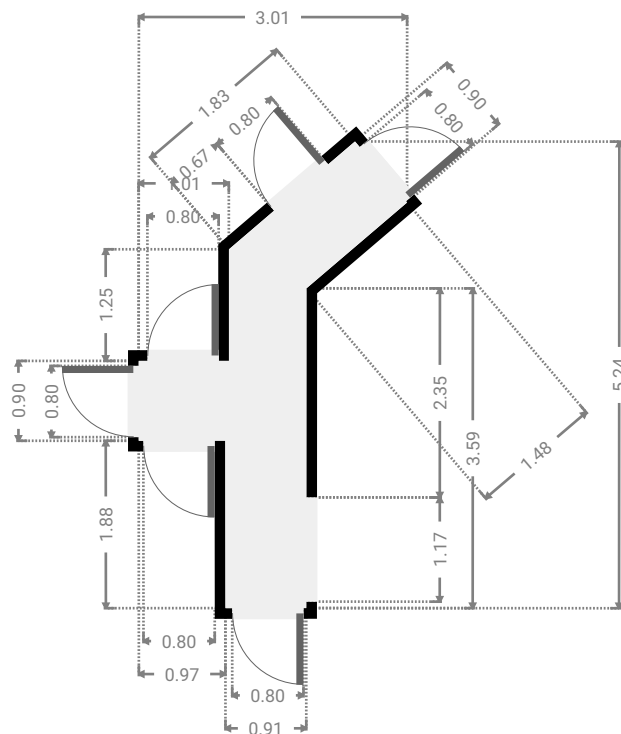
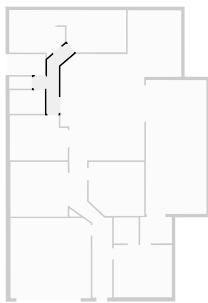

▼ **Bathroom**
Ground Floor

WIDTH:2.65 m · LENGTH:1.76 m
AREA:4.66 m² · PERIMETER:8.82 m

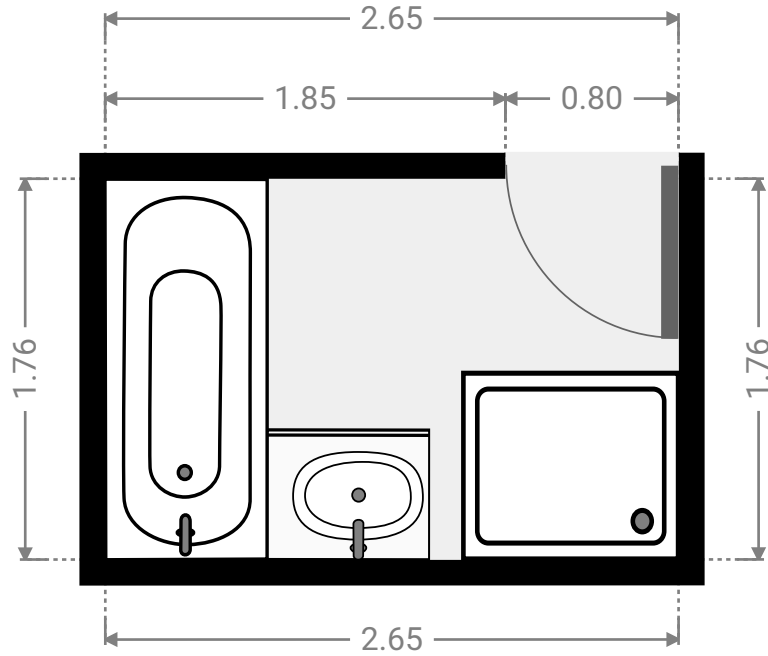
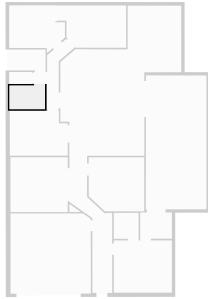

▼ **Toilet**
Ground Floor

WIDTH:1.70 m · LENGTH:0.90 m
AREA:1.53 m² · PERIMETER:5.20 m

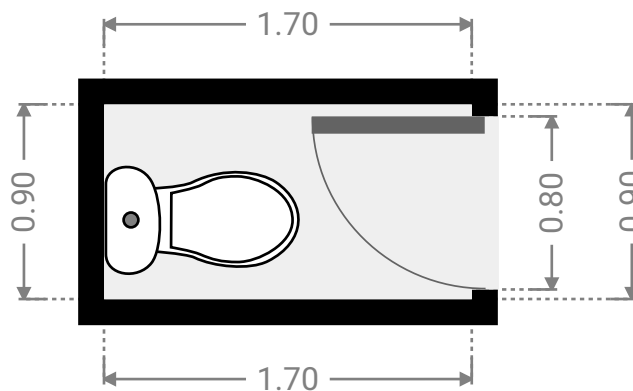
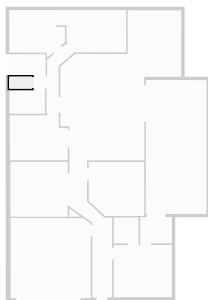

▼ Laundry Room
Ground Floor

WIDTH:2.74 m · LENGTH:1.56 m
AREA:4.27 m² · PERIMETER:8.60 m

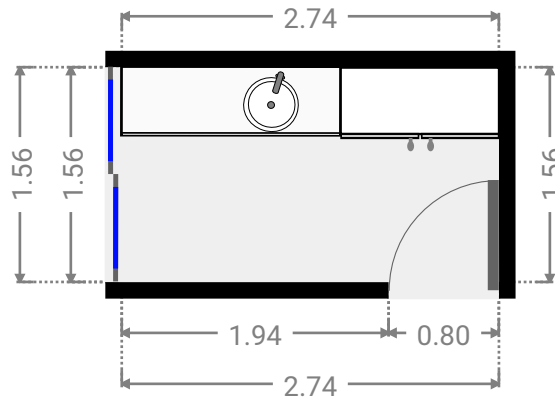
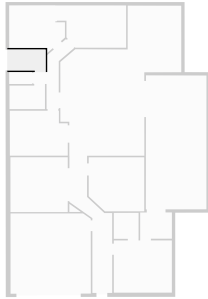

▼ Bedroom
Ground Floor

WIDTH:4.18 m · LENGTH:3.57 m
AREA:12.11 m² · PERIMETER:14.69 m

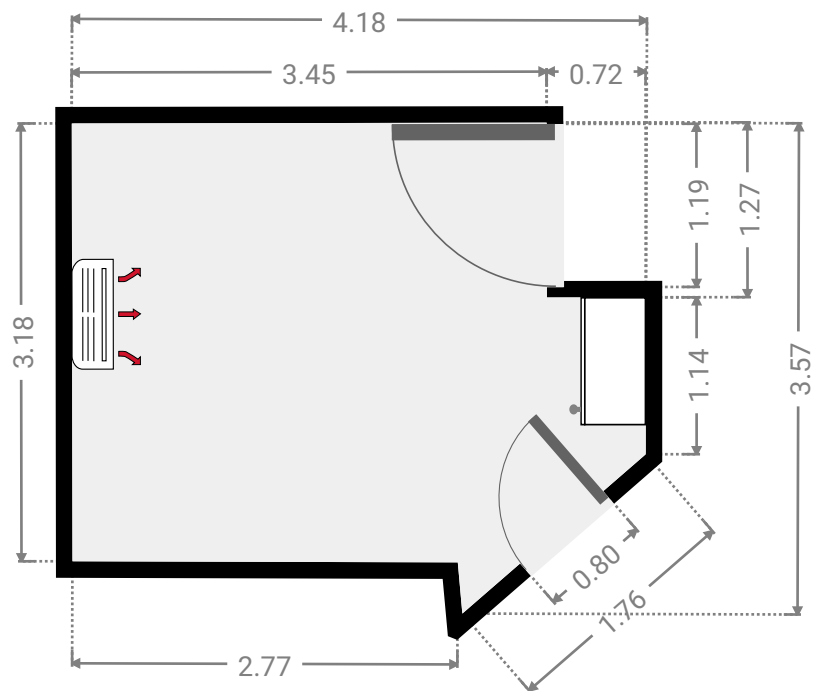
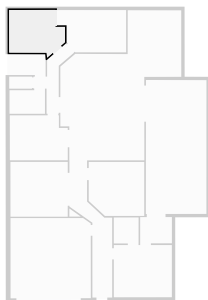

▼ Bedroom

Ground Floor

WIDTH:5.18 m · LENGTH:3.16 m
AREA:14.65 m² · PERIMETER:16.26 m

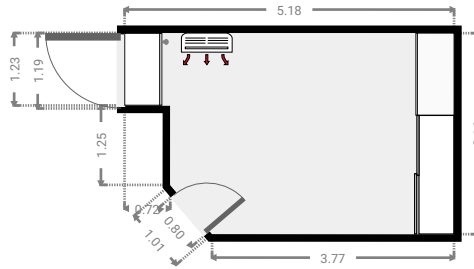
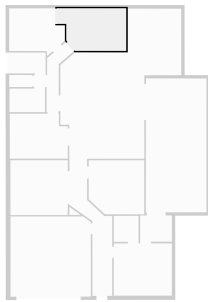

▼ Other

Ground Floor

WIDTH:4.55 m · LENGTH:10.02 m
AREA:45.32 m² · PERIMETER:29.07 m

