

2 Maddison Avenue

Ground Floor

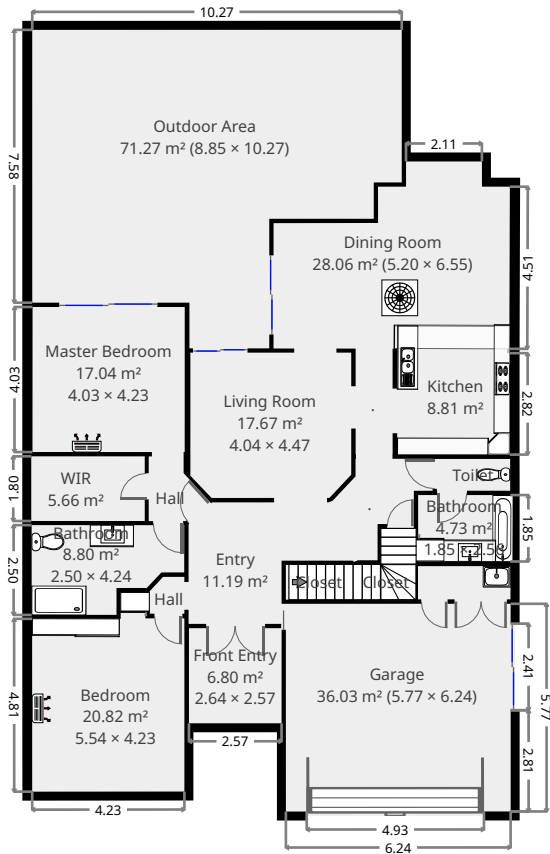
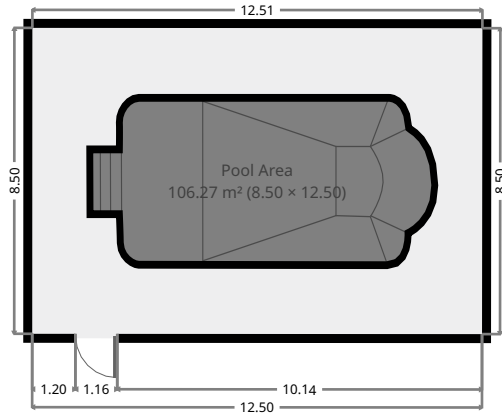
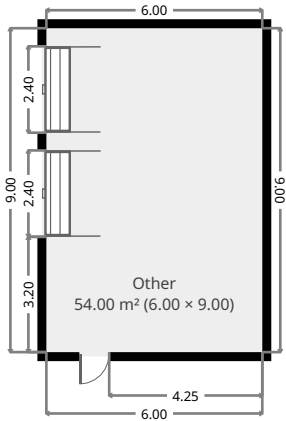

THIS FLOORPLAN IS PROVIDED WITHOUT WARRANTY OF ANY KIND. SENSOPIA DISCLAIMS ANY WARRANTY INCLUDING, WITHOUT LIMITATION, SATISFACTORY QUALITY OR ACCURACY OF DIMENSIONS.

2 Maddison Avenue

Kitchen

Width: 2.82 m
Length: 3.12 m
Area: 8.81 m²
Perimeter: 11.89 m

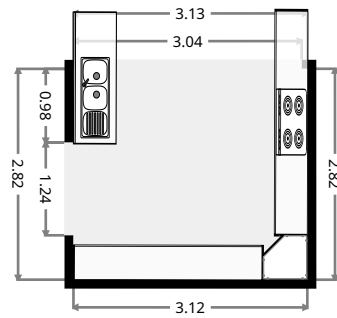
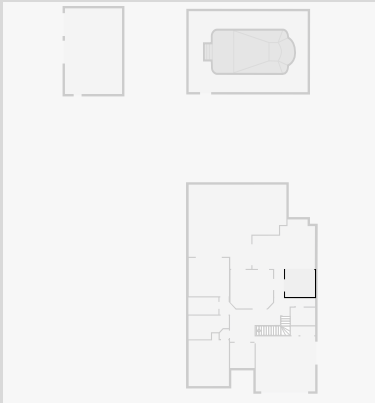

Other

Width: 6.00 m
Length: 9.00 m
Area: 54.00 m²
Perimeter: 30.00 m

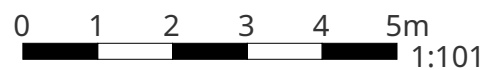
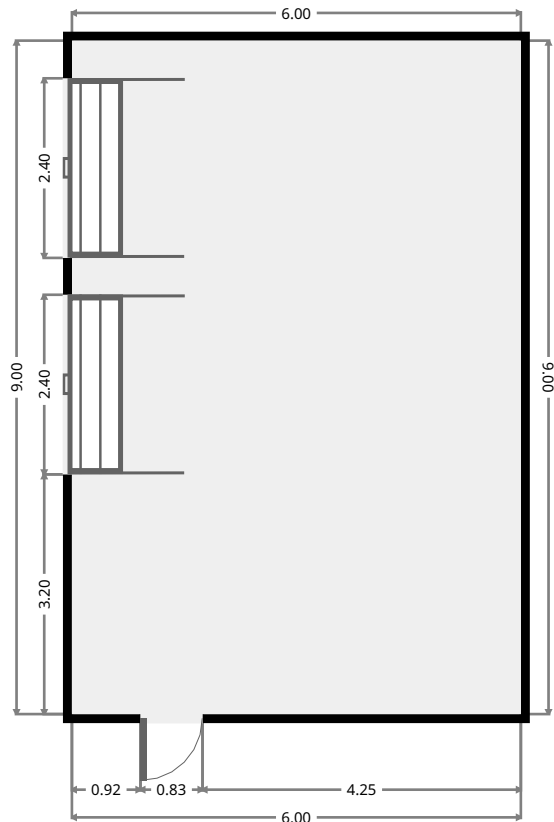
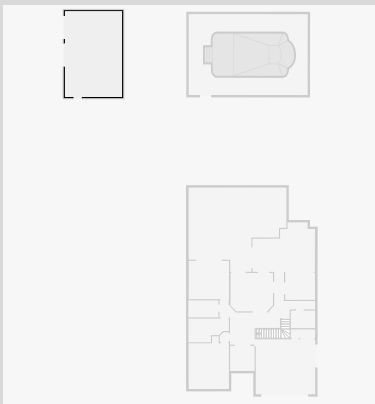

2 Maddison Avenue

Pool Area

Width: 8.50 m
Length: 12.50 m
Area: 106.27 m²
Perimeter: 42.01 m
Ceiling Height: 2.17 m

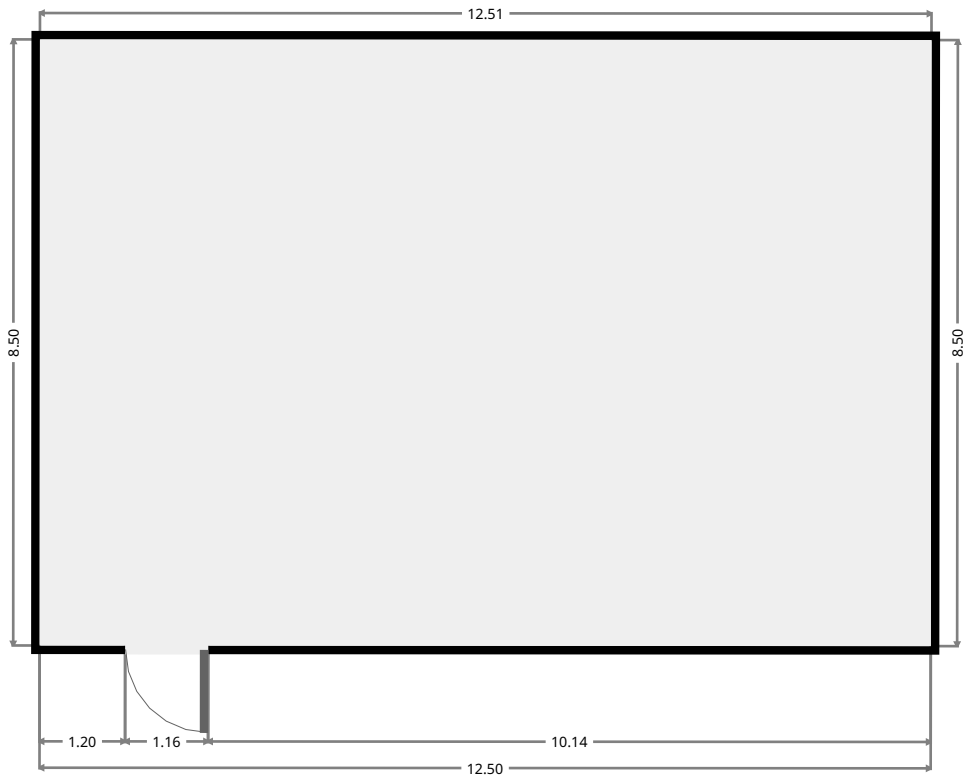
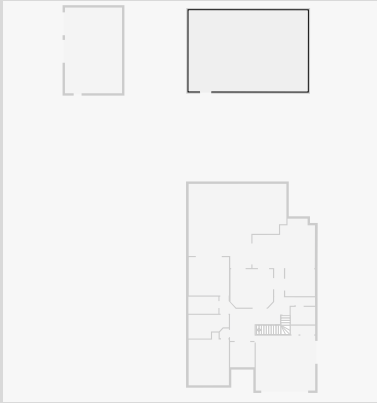

2 Maddison Avenue

Outdoor Area

Width: 8.85 m
Length: 10.27 m
Area: 71.27 m²
Perimeter: 38.23 m
Ceiling Height: 2.17 m

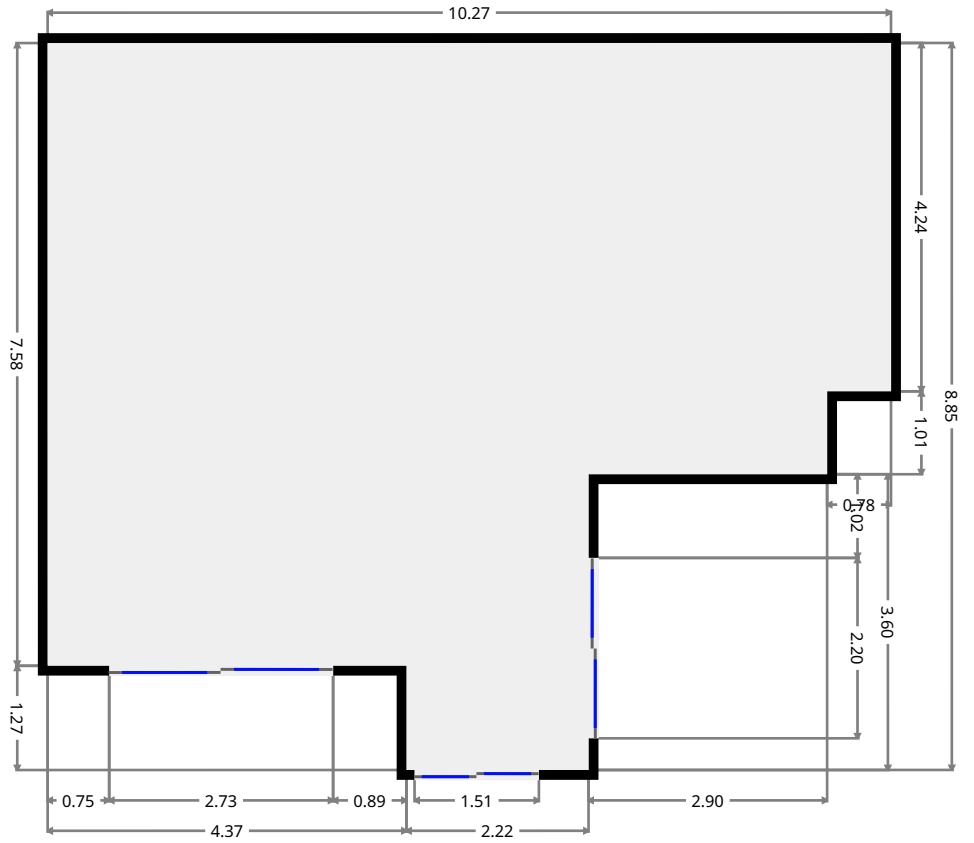
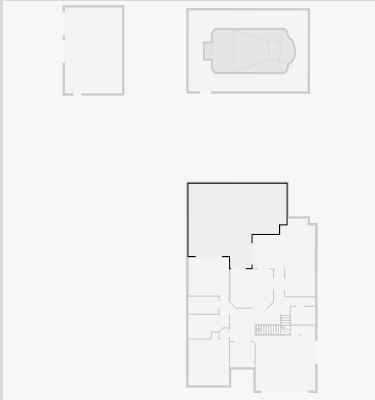

THIS FLOORPLAN IS PROVIDED WITHOUT WARRANTY OF ANY KIND. SENSOPIA DISCLAIMS ANY WARRANTY INCLUDING, WITHOUT LIMITATION, SATISFACTORY QUALITY OR ACCURACY OF DIMENSIONS.



2 Maddison Avenue

Front Entry

Width: 2.57 m
Length: 2.64 m
Area: 6.80 m²
Perimeter: 10.43 m

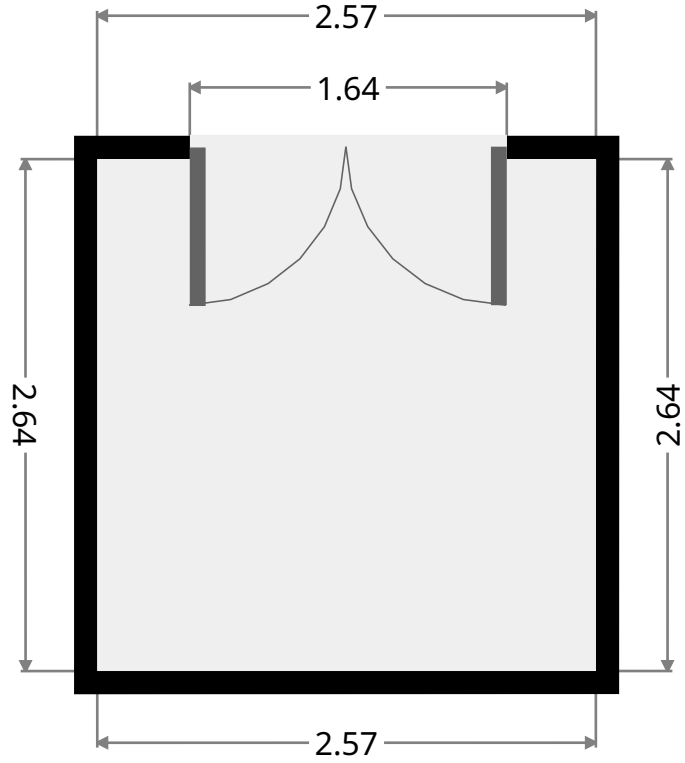
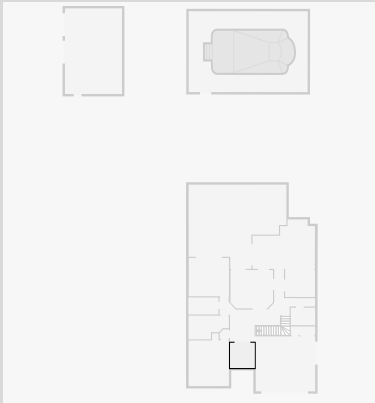

Closet

Width: 0.97 m
Length: 1.90 m
Area: 1.84 m²
Perimeter: 5.74 m

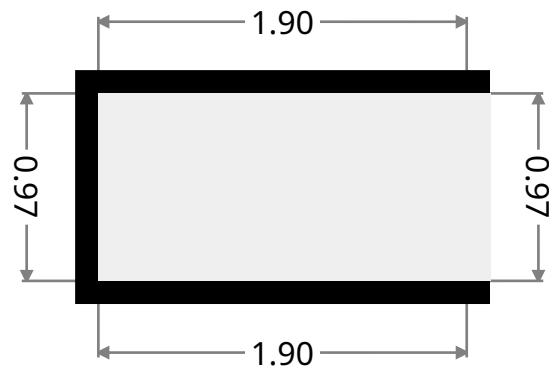
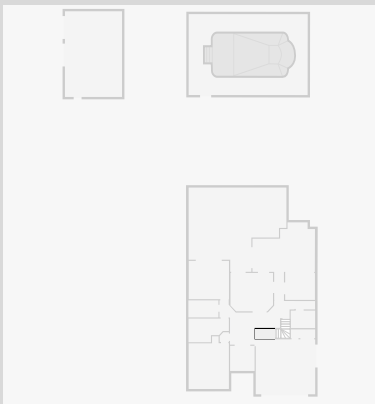

2 Maddison Avenue

Closet

Width: 1.53 m
 Length: 2.00 m
 Area: 2.40 m²
 Perimeter: 7.05 m

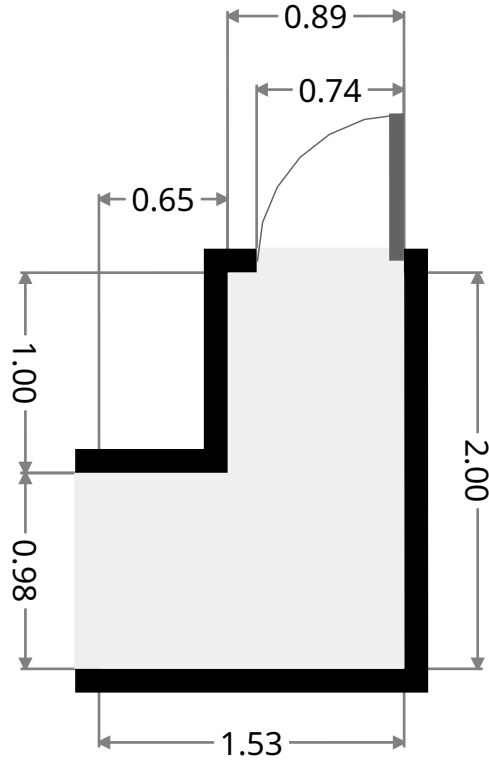
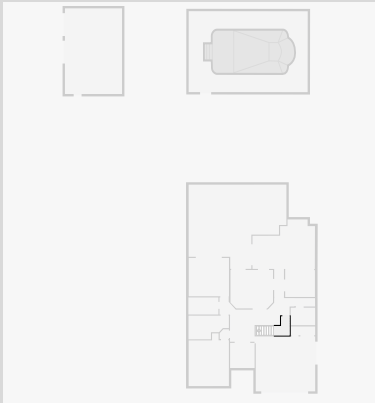

Bathroom

Width: 1.85 m
 Length: 2.56 m
 Area: 4.73 m²
 Perimeter: 8.82 m

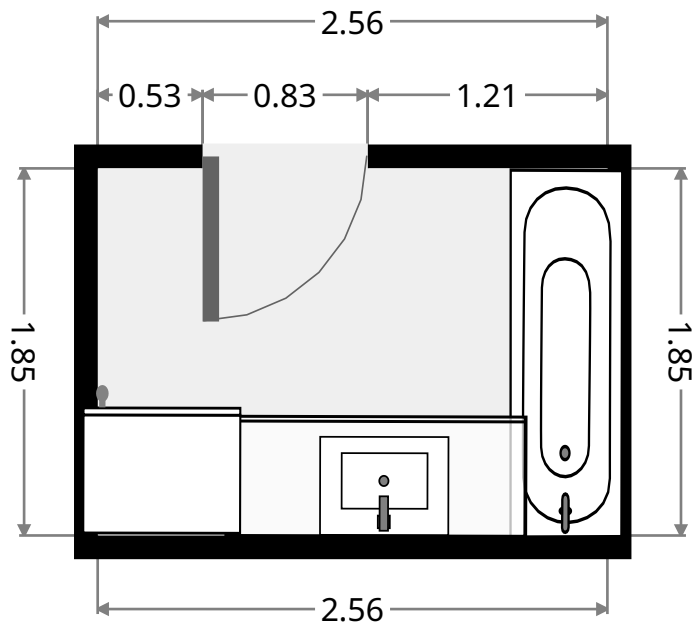
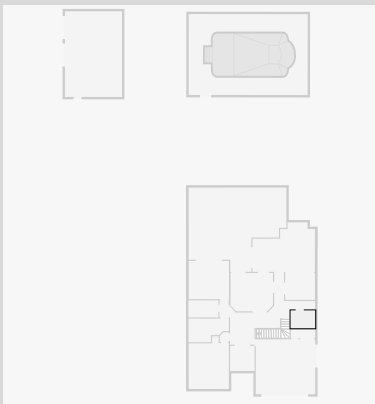

THIS FLOORPLAN IS PROVIDED WITHOUT WARRANTY OF ANY KIND. SENSOPIA DISCLAIMS ANY WARRANTY INCLUDING, WITHOUT LIMITATION, SATISFACTORY QUALITY OR ACCURACY OF DIMENSIONS.

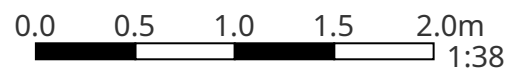

2 Maddison Avenue

Toilet

Width: 0.88 m
 Length: 2.03 m
 Area: 1.80 m²
 Perimeter: 5.83 m

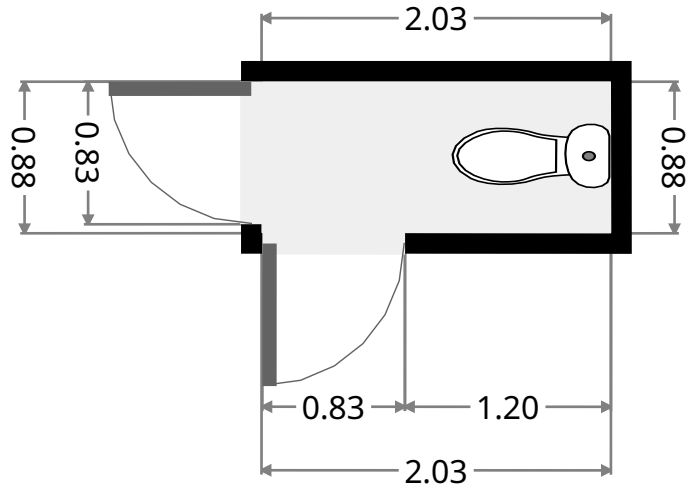
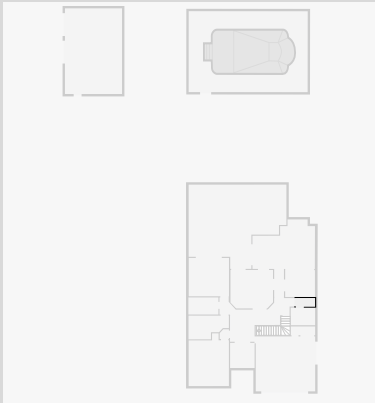

Width: 2.14 m
 Length: 2.82 m
 Area: 4.71 m²
 Perimeter: 10.26 m
 Ceiling Height: 2.17 m

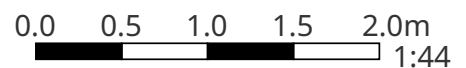
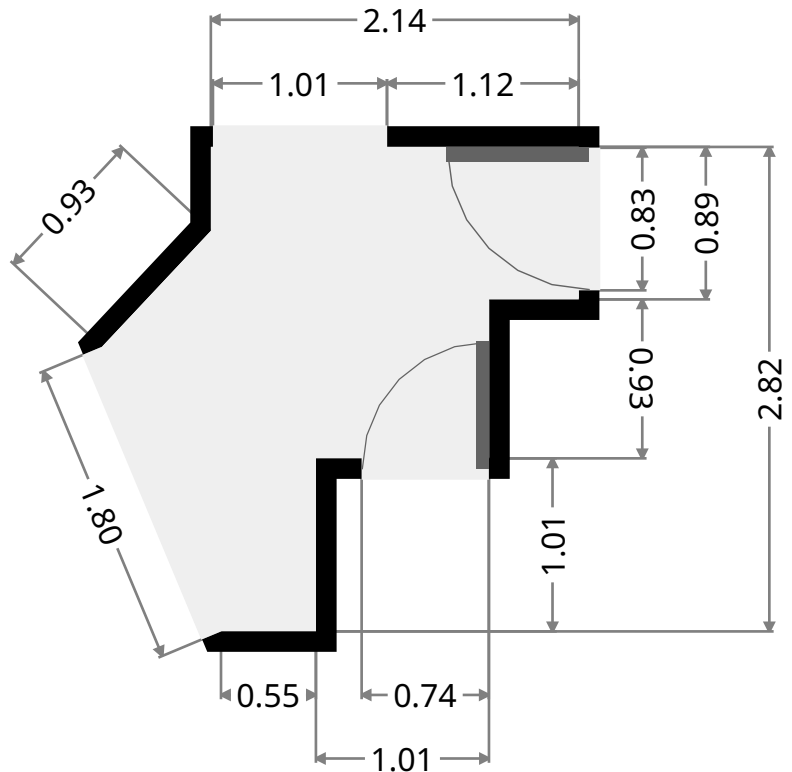
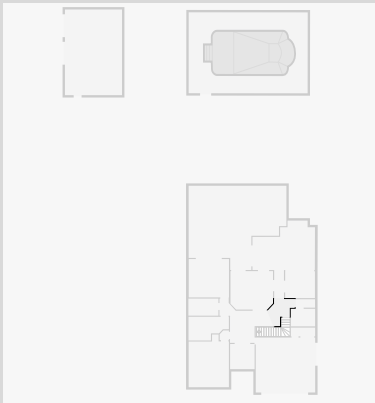

THIS FLOORPLAN IS PROVIDED WITHOUT WARRANTY OF ANY KIND. SENSOPIA DISCLAIMS ANY WARRANTY INCLUDING, WITHOUT LIMITATION, SATISFACTORY QUALITY OR ACCURACY OF DIMENSIONS.

2 Maddison Avenue

Width: 1.02 m
 Length: 2.82 m
 Area: 2.89 m²
 Perimeter: 7.69 m

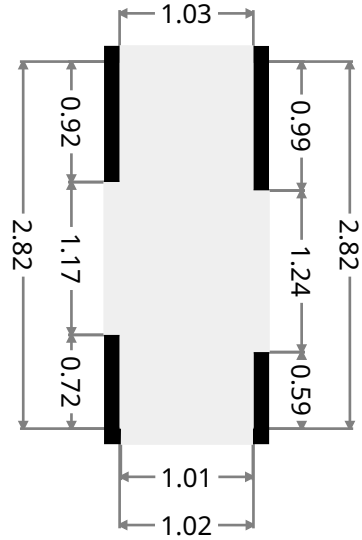
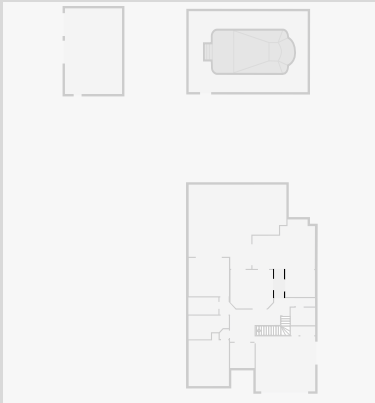

Entry

Width: 3.38 m
 Length: 4.57 m
 Area: 11.19 m²
 Perimeter: 14.99 m
 Ceiling Height: 2.17 m

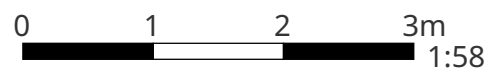
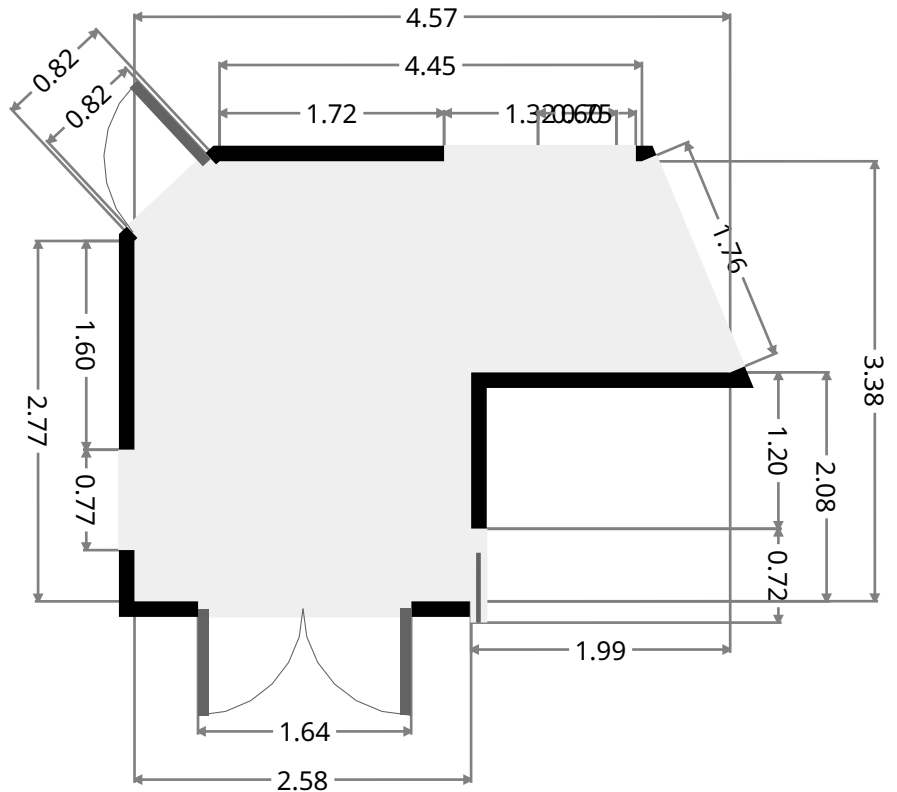
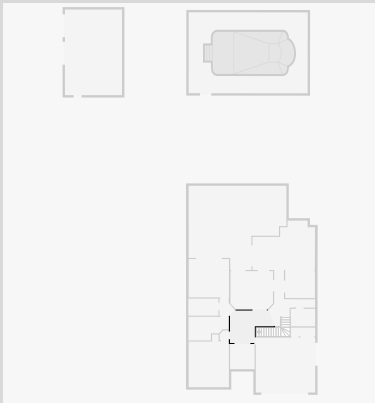

THIS FLOORPLAN IS PROVIDED WITHOUT WARRANTY OF ANY KIND. SENSOPIA DISCLAIMS ANY WARRANTY INCLUDING, WITHOUT LIMITATION, SATISFACTORY QUALITY OR ACCURACY OF DIMENSIONS.

2 Maddison Avenue

Dining Room

Width: 5.20 m
 Length: 6.55 m
 Area: 28.06 m²
 Perimeter: 23.52 m
 Ceiling Height: 2.17 m

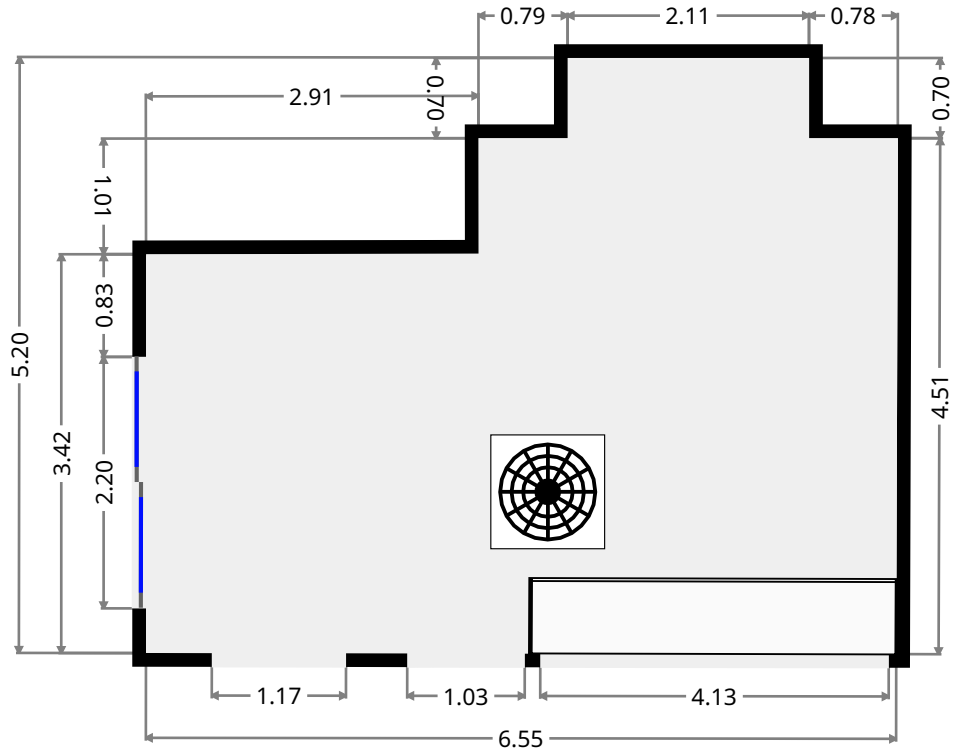
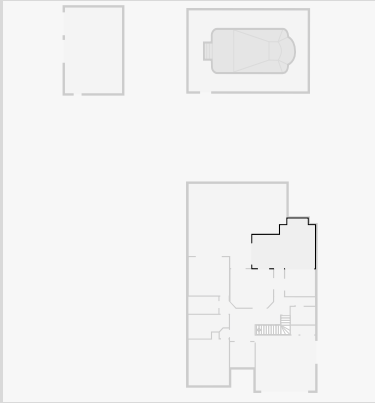

Living Room

Width: 4.04 m
 Length: 4.47 m
 Area: 17.67 m²
 Perimeter: 16.29 m
 Ceiling Height: 2.17 m

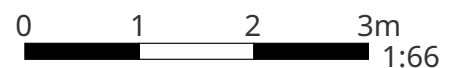
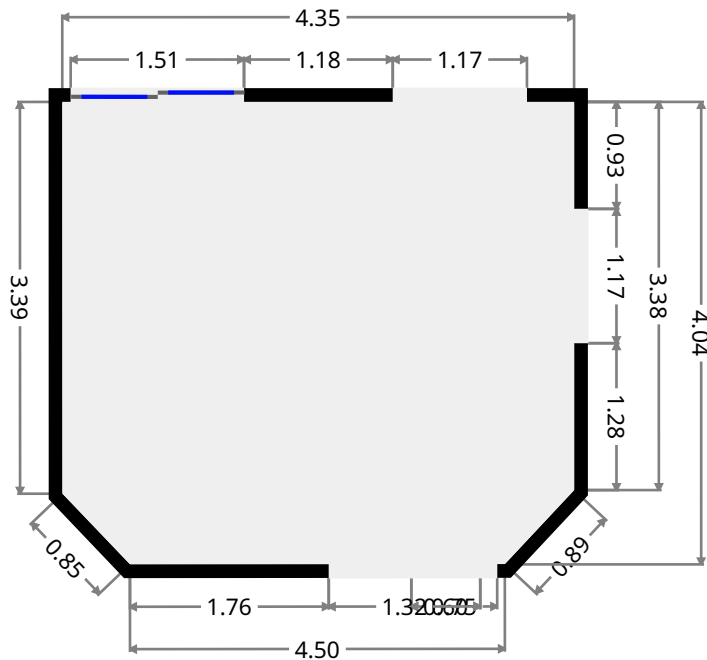
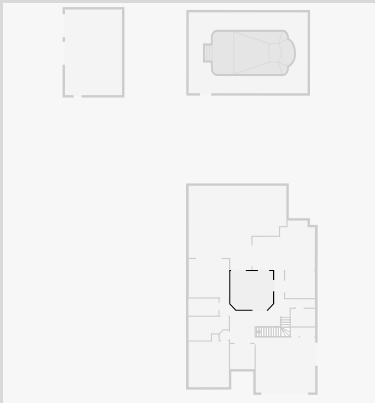

THIS FLOORPLAN IS PROVIDED WITHOUT WARRANTY OF ANY KIND. SENSOPIA DISCLAIMS ANY WARRANTY INCLUDING, WITHOUT LIMITATION, SATISFACTORY QUALITY OR ACCURACY OF DIMENSIONS.

2 Maddison Avenue

Bathroom

Width: 2.50 m
 Length: 4.24 m
 Area: 8.80 m²
 Perimeter: 13.22 m
 Ceiling Height: 2.17 m

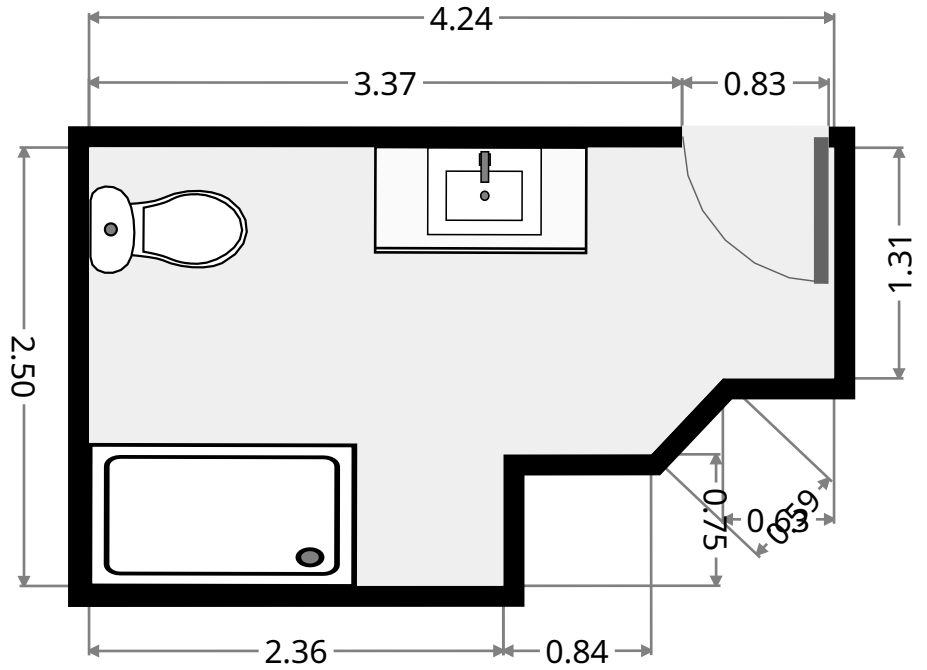
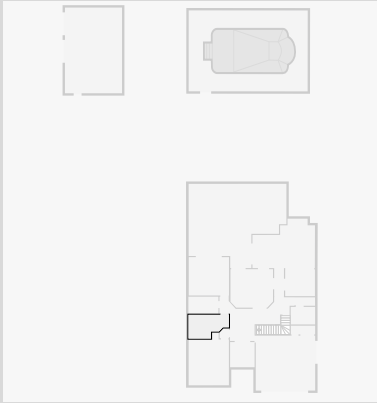

WIR

Width: 1.80 m
 Length: 3.16 m
 Area: 5.66 m²
 Perimeter: 9.90 m

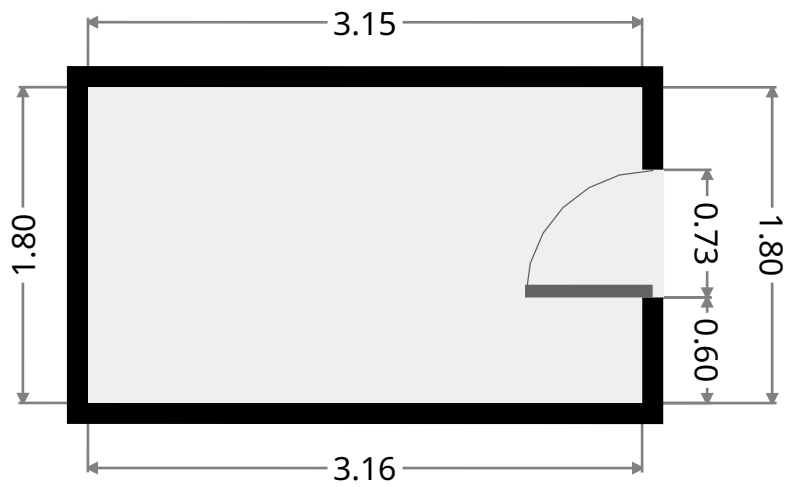
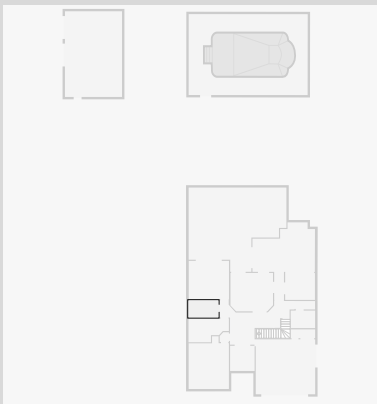

2 Maddison Avenue

Master Bedroom

Width: 4.03 m
 Length: 4.23 m
 Area: 17.04 m²
 Perimeter: 16.52 m

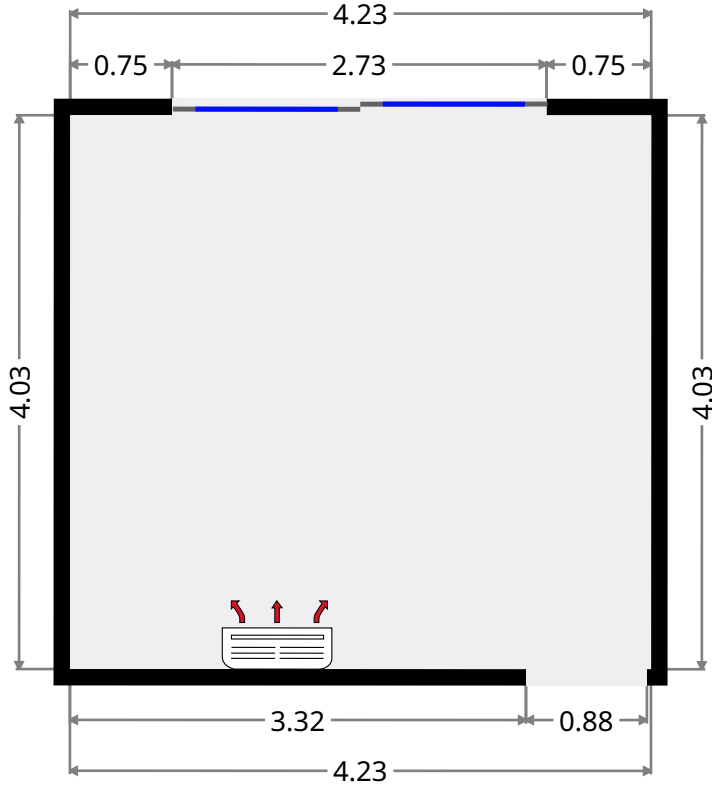
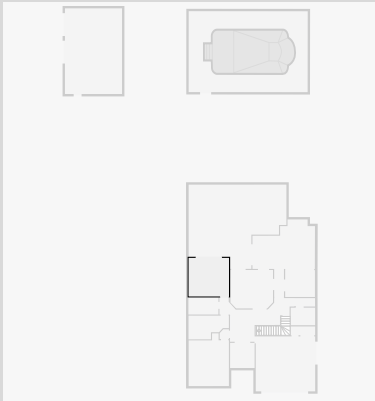

Hall

Width: 0.98 m
 Length: 1.80 m
 Area: 2.22 m²
 Perimeter: 6.13 m
 Ceiling Height: 2.17 m

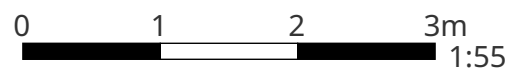
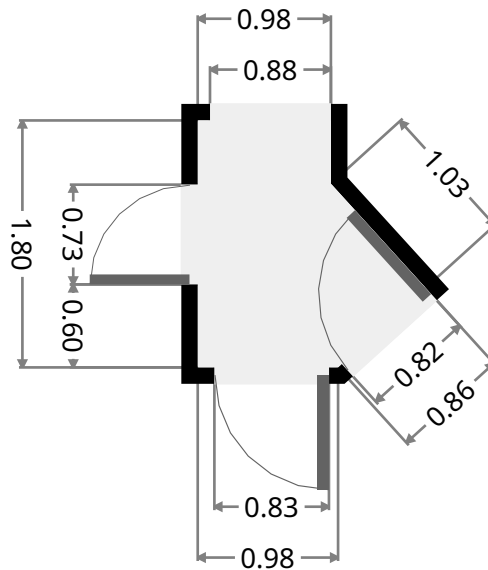
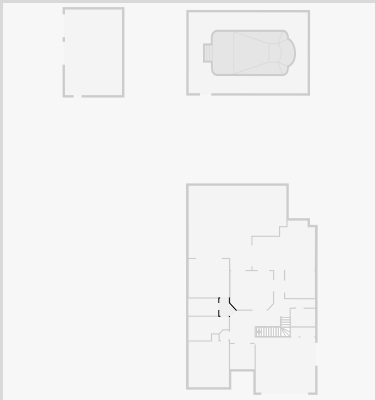

THIS FLOORPLAN IS PROVIDED WITHOUT WARRANTY OF ANY KIND. SENSOPIA DISCLAIMS ANY WARRANTY INCLUDING, WITHOUT LIMITATION, SATISFACTORY QUALITY OR ACCURACY OF DIMENSIONS.

2 Maddison Avenue

Bedroom

Width: 4.23 m
 Length: 5.54 m
 Area: 20.82 m²
 Perimeter: 19.54 m
 Ceiling Height: 2.17 m

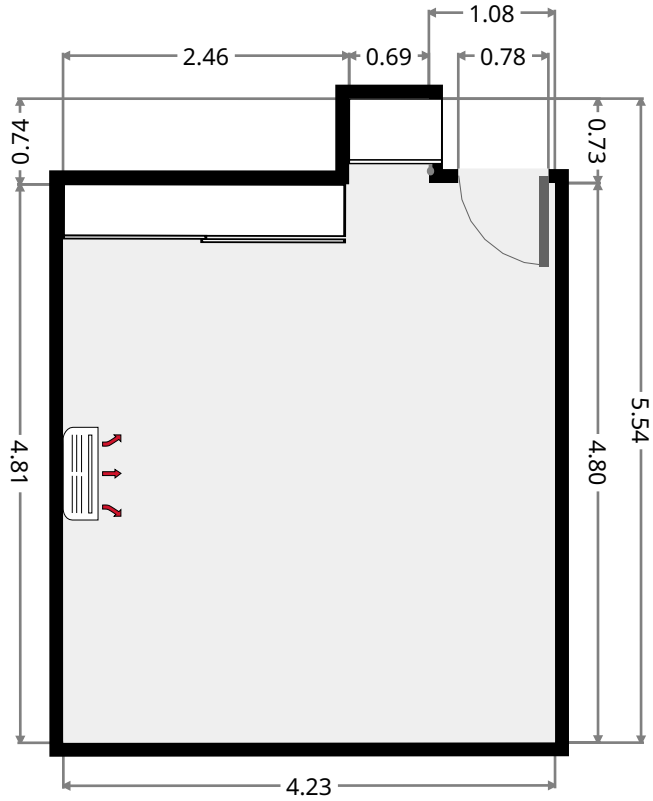
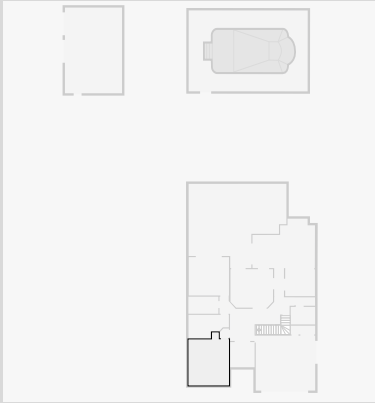

Hall

Width: 0.96 m
 Length: 1.02 m
 Area: 0.91 m²
 Perimeter: 3.75 m
 Ceiling Height: 2.17 m

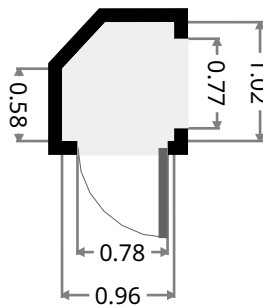
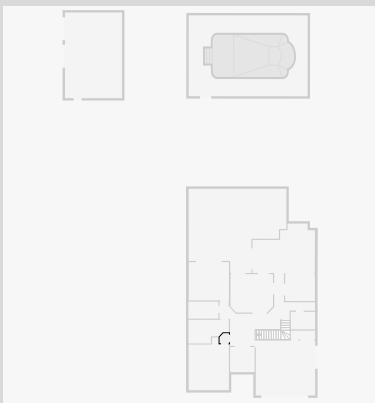

2 Maddison Avenue

Laundry Room

Width: 0.92 m
 Length: 2.57 m
 Area: 2.37 m²
 Perimeter: 6.99 m

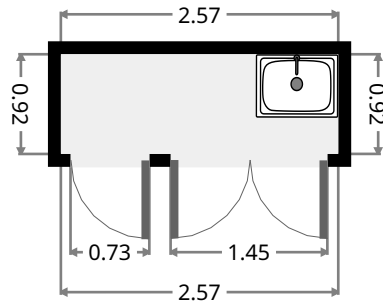
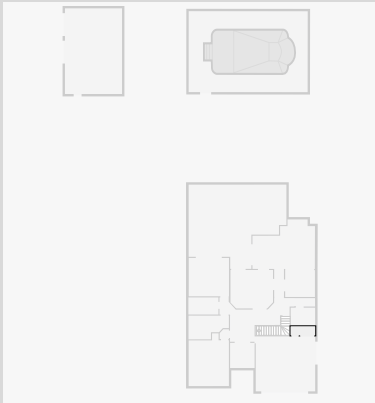

Garage

Width: 5.77 m
 Length: 6.24 m
 Area: 36.03 m²
 Perimeter: 24.03 m

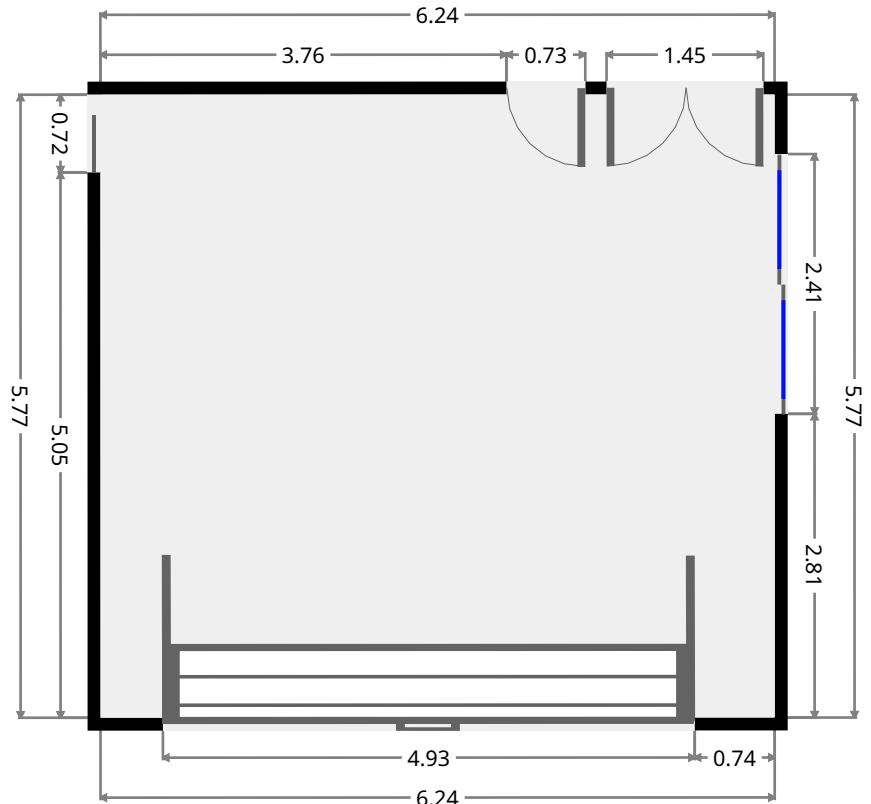
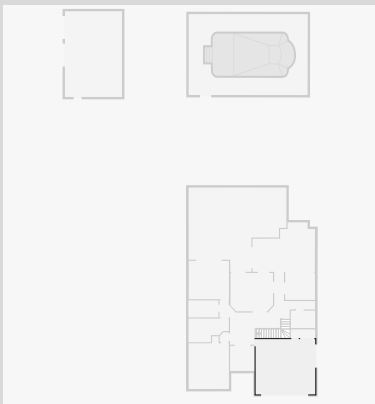

THIS FLOORPLAN IS PROVIDED WITHOUT WARRANTY OF ANY KIND. SENSOPIA DISCLAIMS ANY WARRANTY INCLUDING, WITHOUT LIMITATION, SATISFACTORY QUALITY OR ACCURACY OF DIMENSIONS.

2 Maddison Avenue

1st Floor

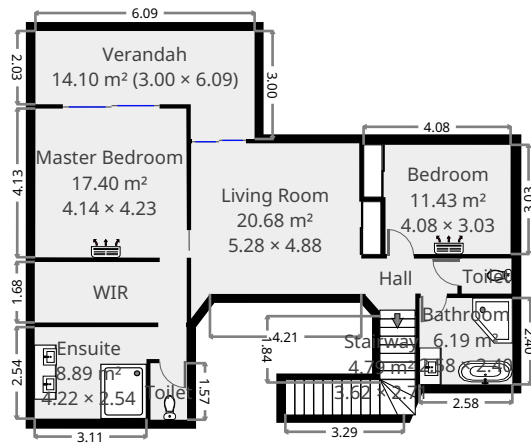

THIS FLOORPLAN IS PROVIDED WITHOUT WARRANTY OF ANY KIND. SENSOPIA DISCLAIMS ANY WARRANTY INCLUDING, WITHOUT LIMITATION, SATISFACTORY QUALITY OR ACCURACY OF DIMENSIONS.



2 Maddison Avenue

Master Bedroom

Width: 4.14 m
 Length: 4.23 m
 Area: 17.40 m²
 Perimeter: 16.68 m

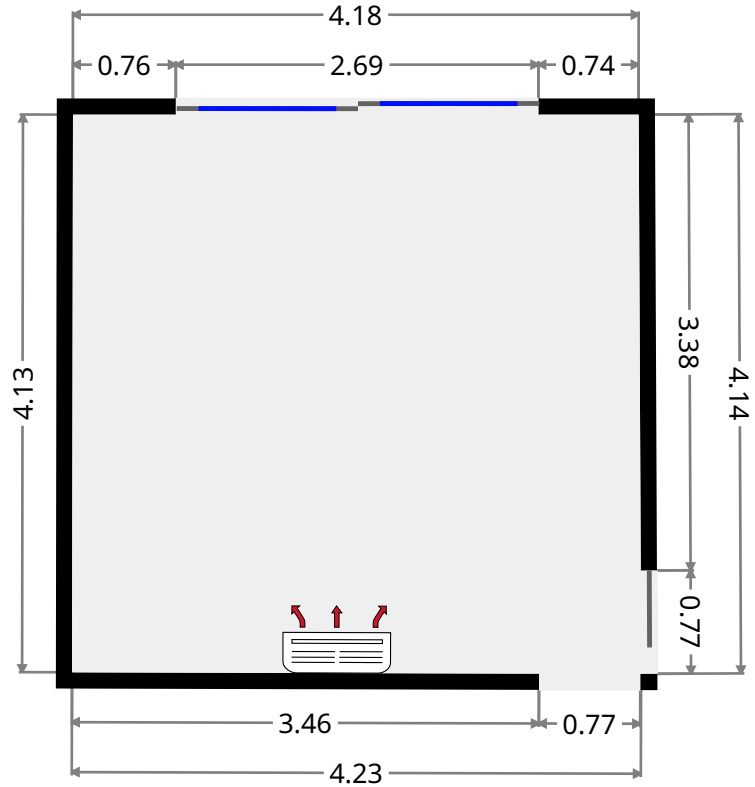
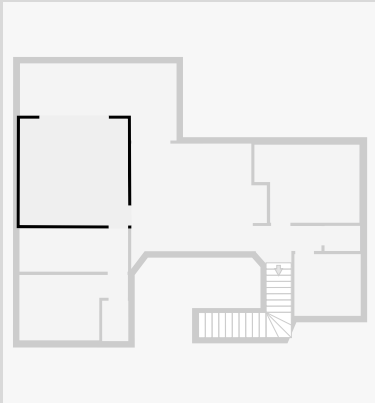

WIR

Width: 1.68 m
 Length: 4.22 m
 Area: 7.10 m²
 Perimeter: 11.81 m

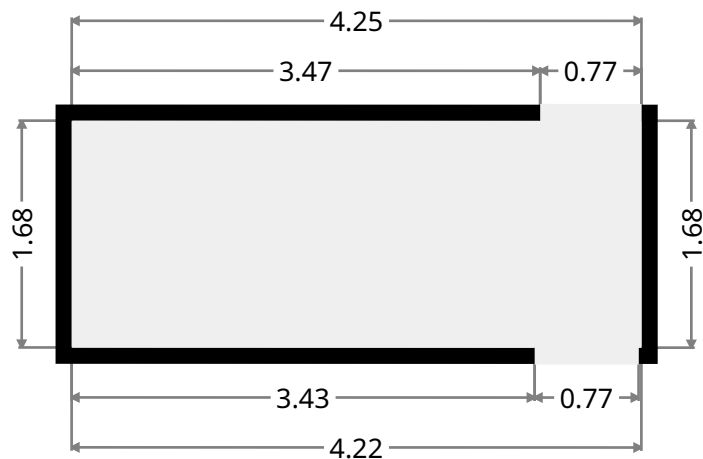
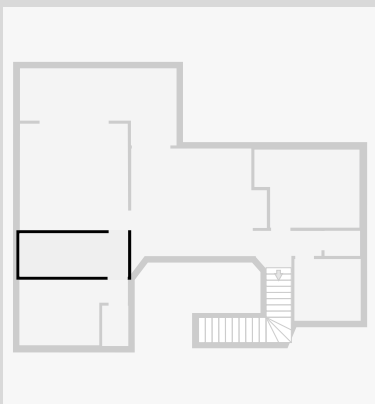

2 Maddison Avenue

Toilet

Width: 1.02 m
 Length: 1.57 m
 Area: 1.60 m²
 Perimeter: 5.17 m

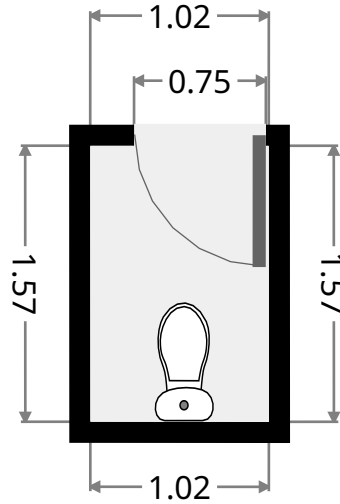
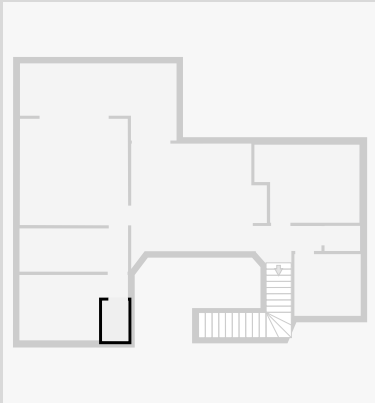

Ensuite

Width: 2.54 m
 Length: 4.22 m
 Area: 8.89 m²
 Perimeter: 13.52 m

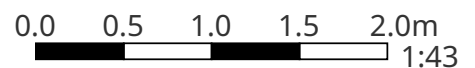
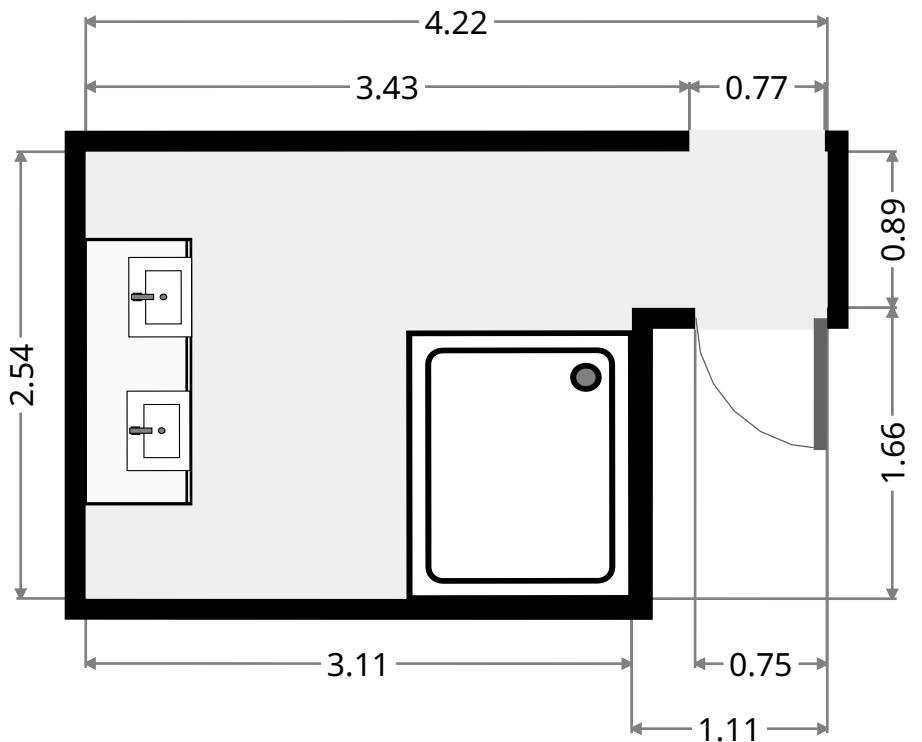
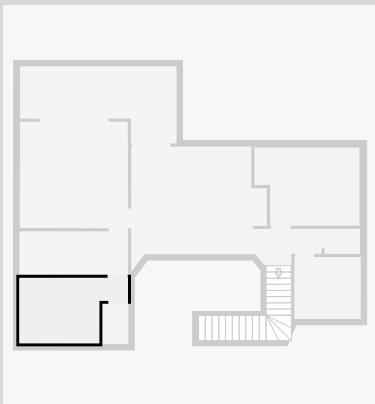

THIS FLOORPLAN IS PROVIDED WITHOUT WARRANTY OF ANY KIND. SENSOPIA DISCLAIMS ANY WARRANTY INCLUDING, WITHOUT LIMITATION, SATISFACTORY QUALITY OR ACCURACY OF DIMENSIONS.

2 Maddison Avenue

Living Room

Width: 4.88 m
 Length: 5.28 m
 Area: 20.68 m²
 Perimeter: 19.95 m

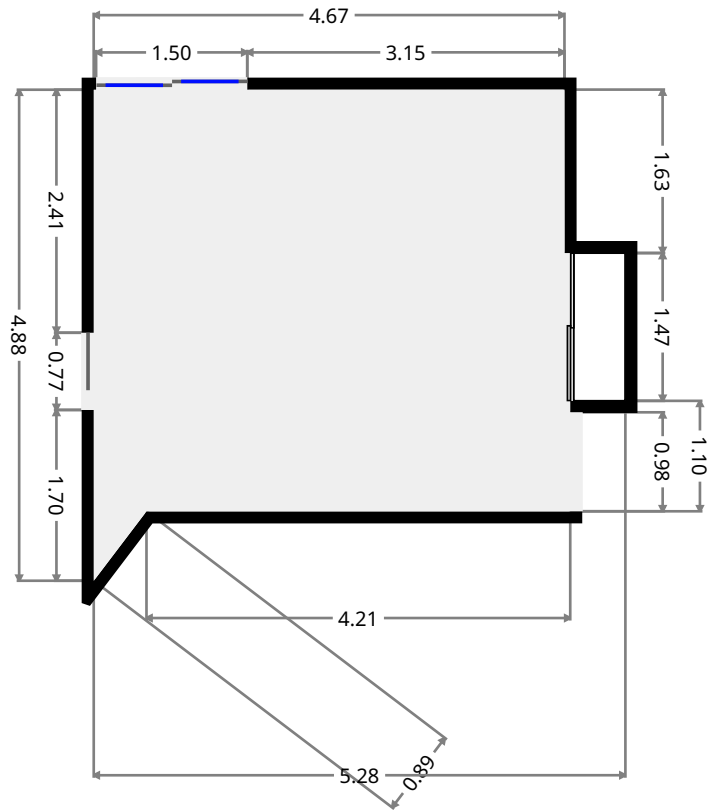
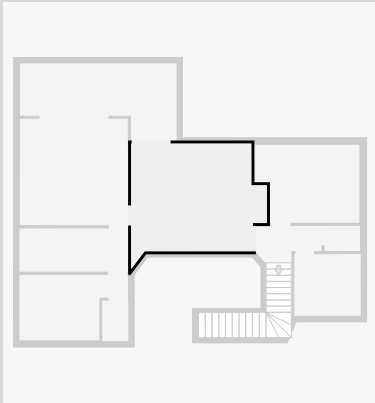

Hall

Width: 1.48 m
 Length: 2.55 m
 Area: 3.09 m²
 Perimeter: 7.81 m
 Ceiling Height: 2.17 m

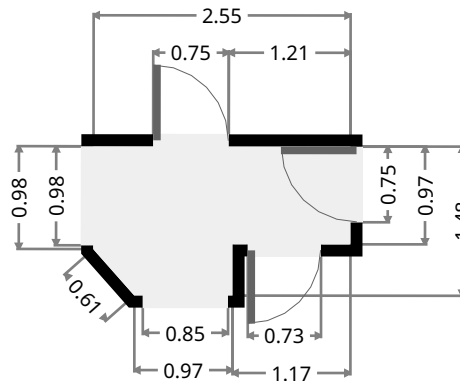
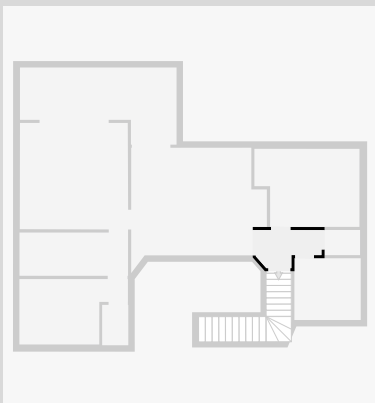

2 Maddison Avenue

Bedroom

Width: 3.03 m
 Length: 4.08 m
 Area: 11.43 m²
 Perimeter: 14.24 m

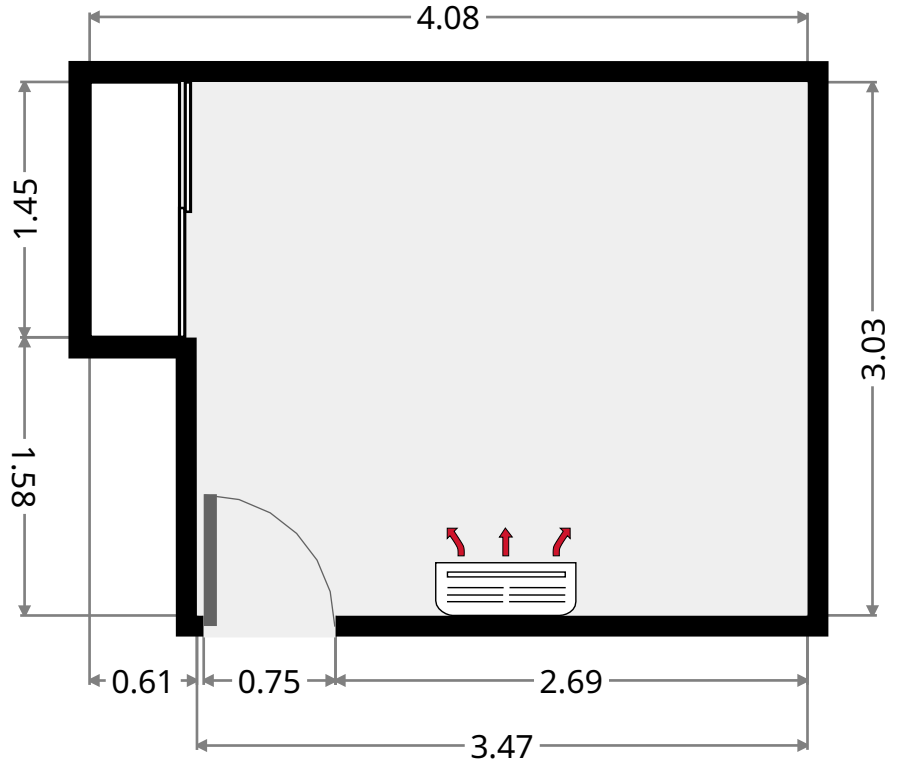
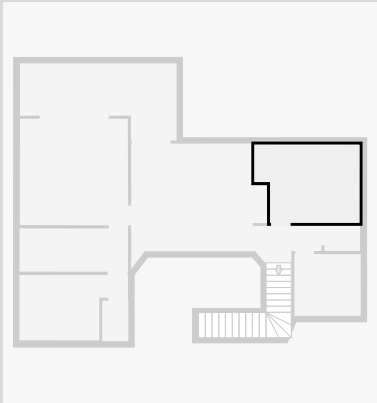

Toilet

Width: 0.98 m
 Length: 1.38 m
 Area: 1.35 m²
 Perimeter: 4.72 m

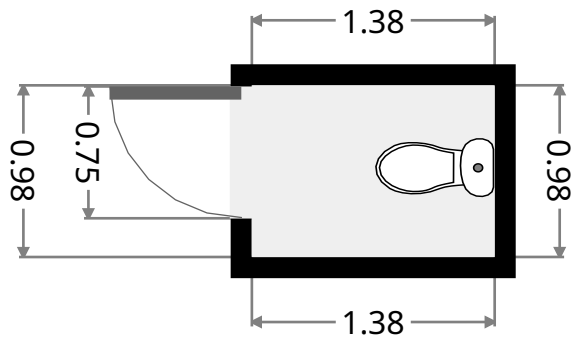
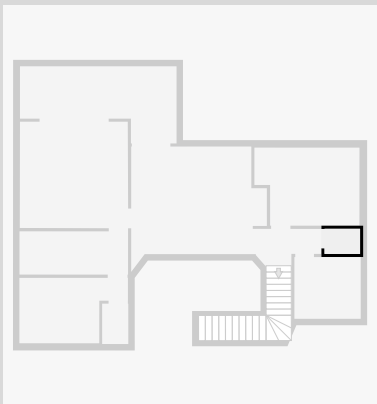

2 Maddison Avenue

Bathroom

Width: 2.40 m
 Length: 2.58 m
 Area: 6.19 m²
 Perimeter: 9.96 m

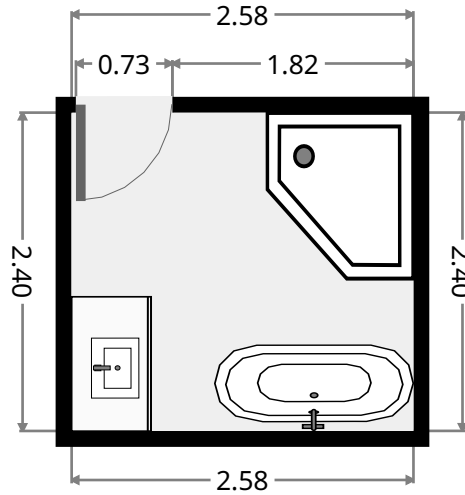
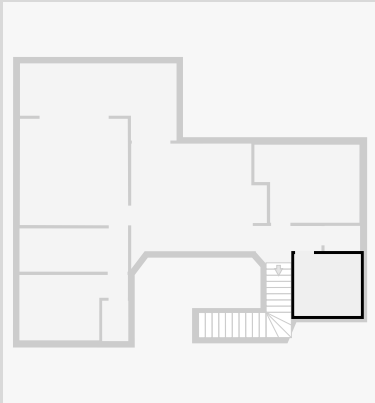

Verandah

Width: 3.00 m
 Length: 6.09 m
 Area: 14.10 m²
 Perimeter: 18.18 m
 Ceiling Height: 2.17 m

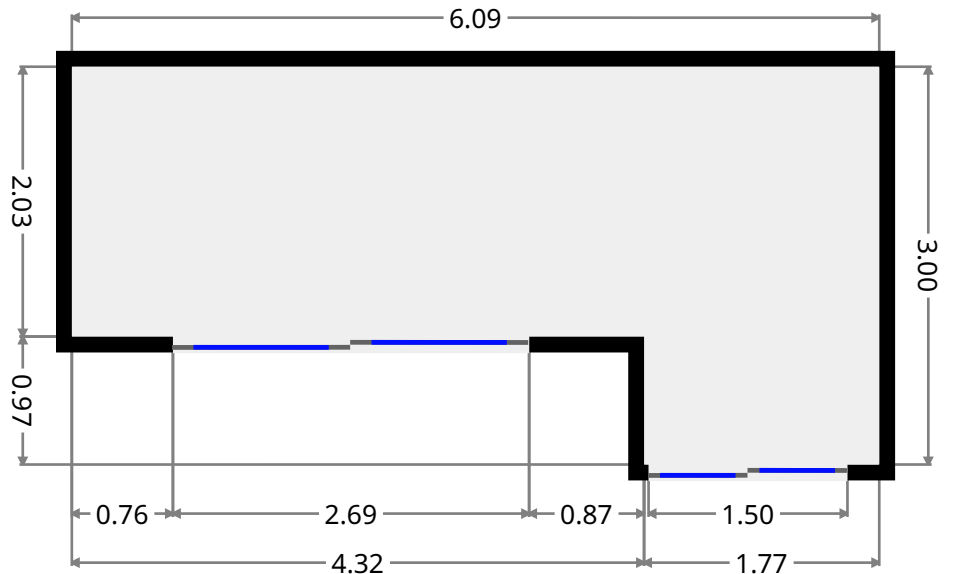
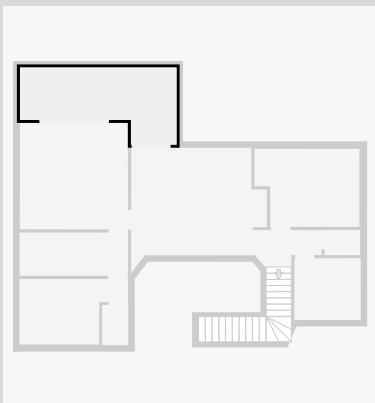

THIS FLOORPLAN IS PROVIDED WITHOUT WARRANTY OF ANY KIND. SENSOPIA DISCLAIMS ANY WARRANTY INCLUDING, WITHOUT LIMITATION, SATISFACTORY QUALITY OR ACCURACY OF DIMENSIONS.

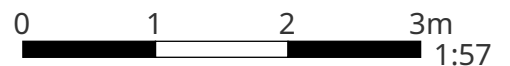

2 Maddison Avenue

Stairway

Width: 2.71 m
Length: 3.62 m
Area: 4.79 m²
Perimeter: 12.40 m

