

2 Aimee Court

SUBMITTED BY

Ray White Rockhampton Casey
stockers@cqoz.com

CREATED ON

2021-11-25

Floors

1

▼ Ground Floor

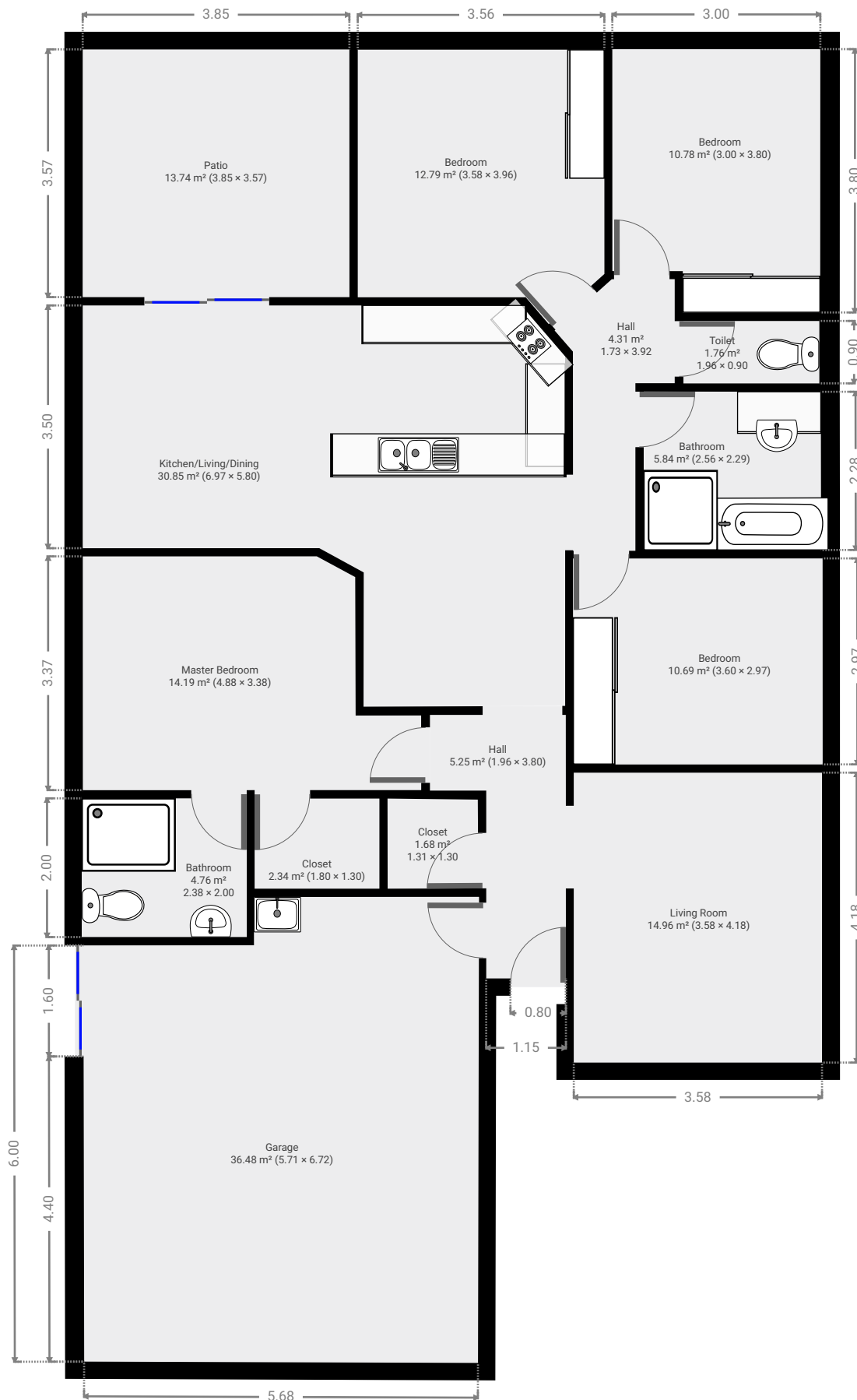

2 Aimee Court

FLOORS: 1

▼ Hall Ground Floor

WIDTH: 1.96 m • LENGTH: 3.80 m
AREA: 5.25 m² • PERIMETER: 11.52 m

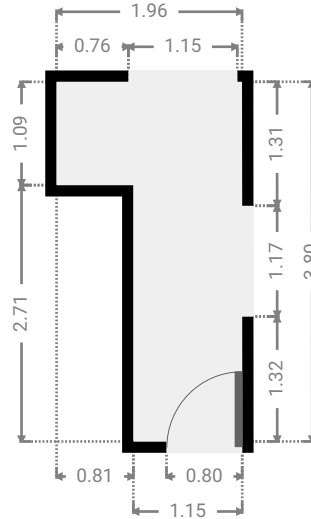
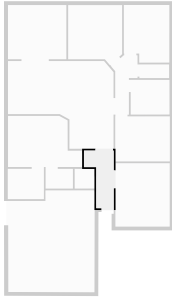

▼ Garage Ground Floor

WIDTH: 5.71 m • LENGTH: 6.72 m
AREA: 36.48 m² • PERIMETER: 24.80 m

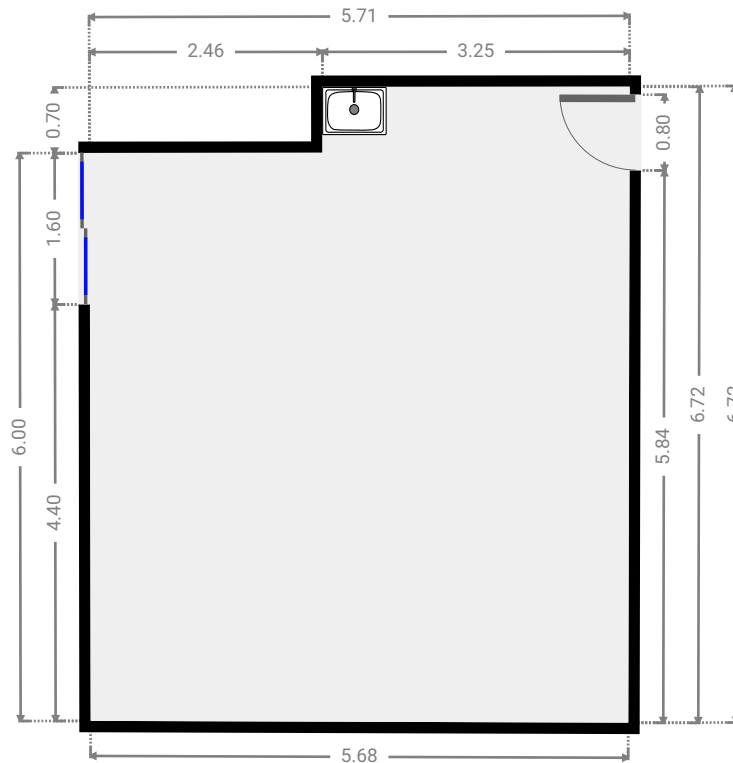
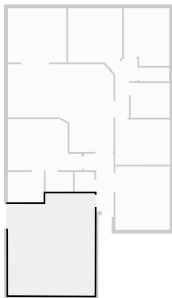

▼ Living Room Ground Floor

WIDTH: 3.58 m • LENGTH: 4.18 m
AREA: 14.96 m² • PERIMETER: 15.52 m

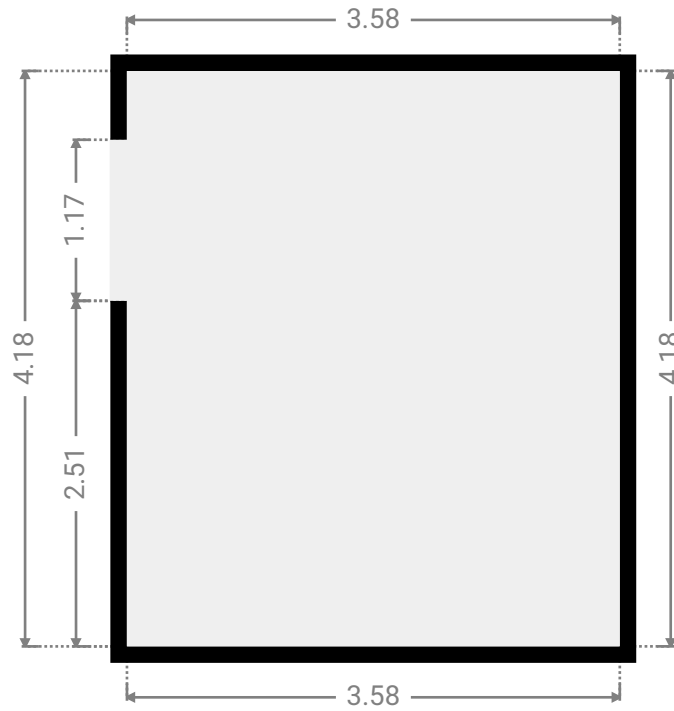
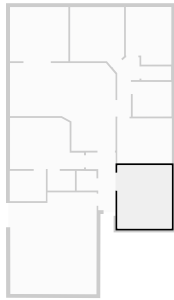

▼ Master Bedroom Ground Floor

WIDTH: 4.88 m • LENGTH: 3.38 m
AREA: 14.19 m² • PERIMETER: 16.27 m

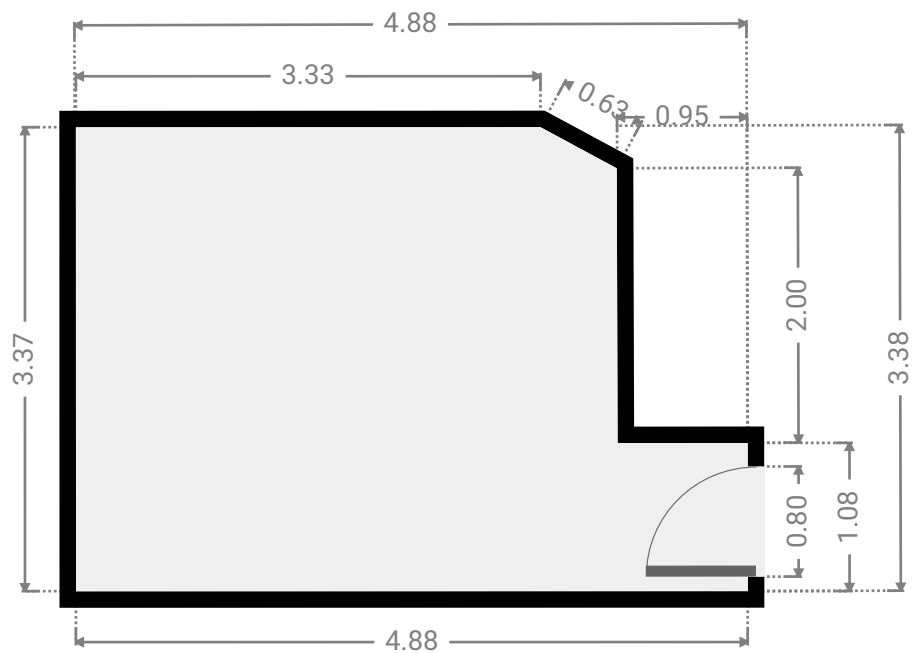
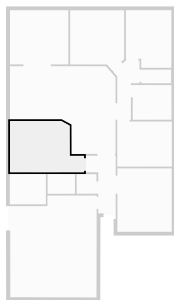

▼ Bathroom Ground Floor

WIDTH: 2.38 m • LENGTH: 2.00 m
AREA: 4.76 m² • PERIMETER: 8.76 m

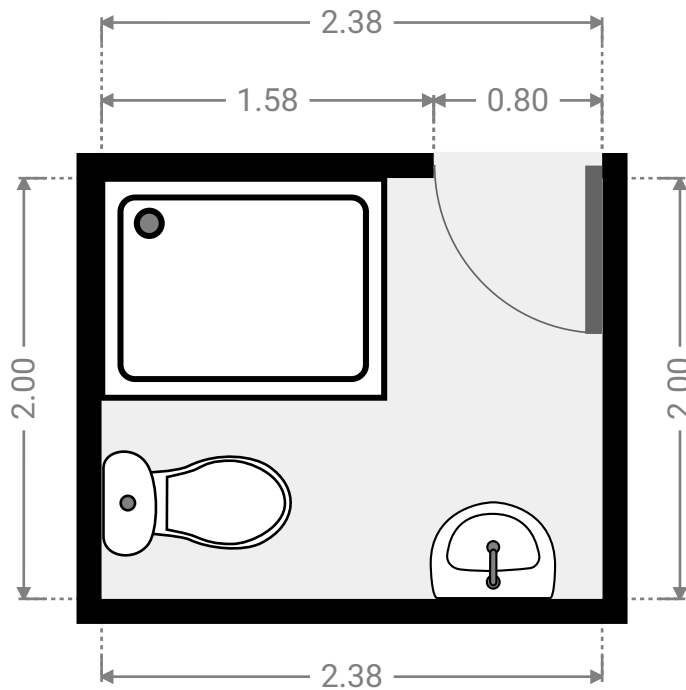
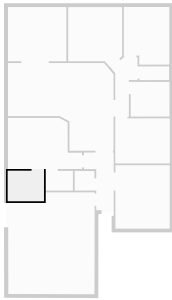

▼ Closet Ground Floor

WIDTH: 1.80 m • LENGTH: 1.30 m
AREA: 2.34 m² • PERIMETER: 6.20 m

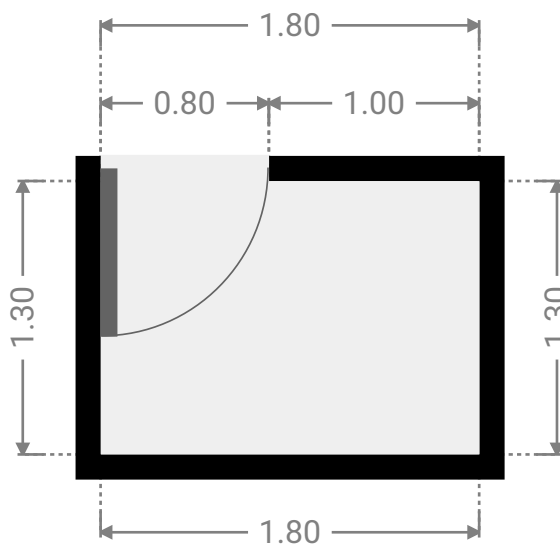
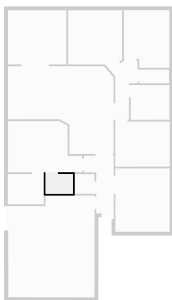

▼ **Closet**
Ground Floor

WIDTH: 1.31 m • LENGTH: 1.30 m
AREA: 1.68 m² • PERIMETER: 5.19 m

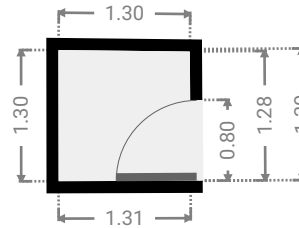
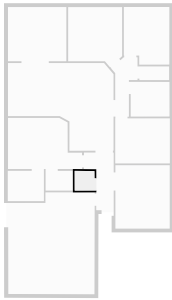

▼ **Kitchen/Living/Dining**
Ground Floor

WIDTH: 6.97 m • LENGTH: 5.80 m
AREA: 30.85 m² • PERIMETER: 24.82 m

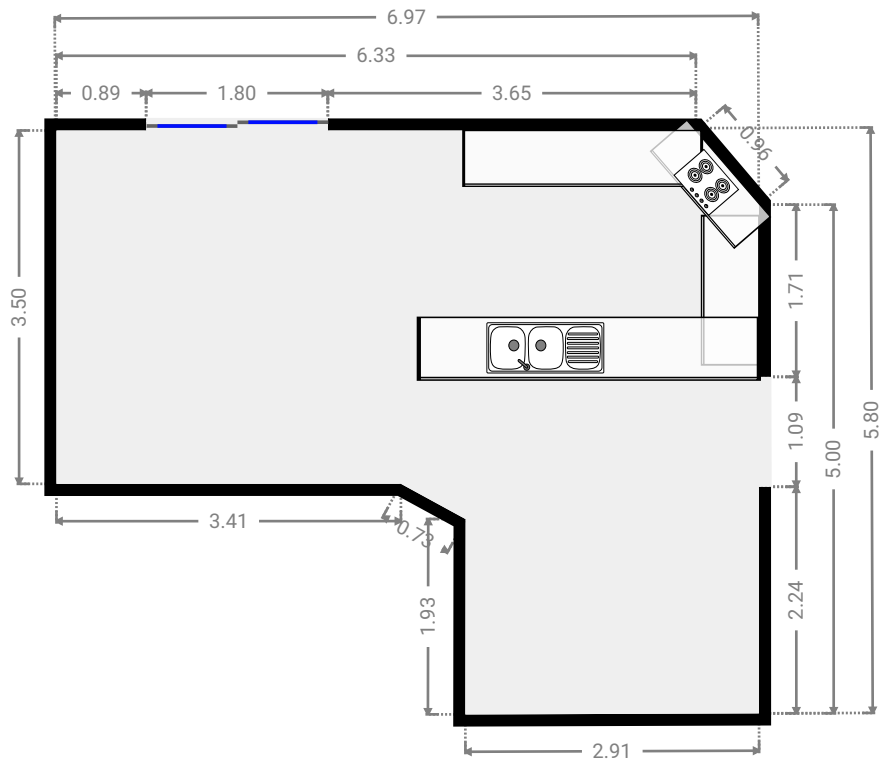
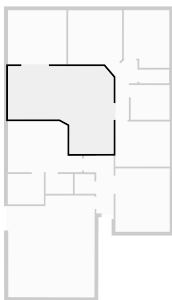

▼ Hall Ground Floor

WIDTH: 1.73 m • LENGTH: 3.92 m
AREA: 4.31 m² • PERIMETER: 10.67 m

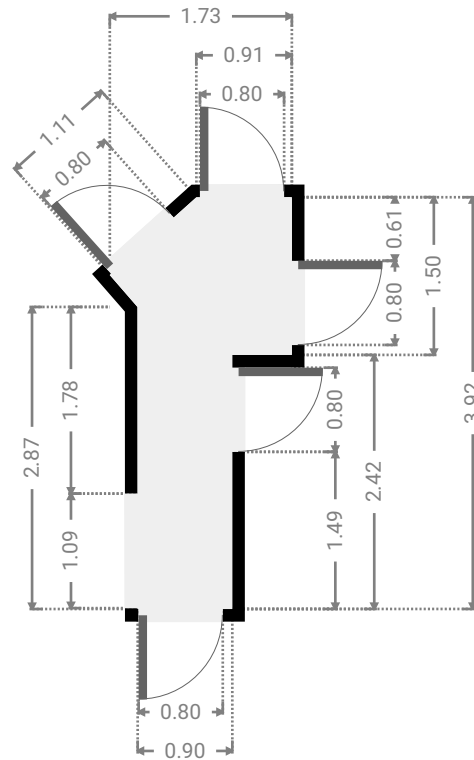
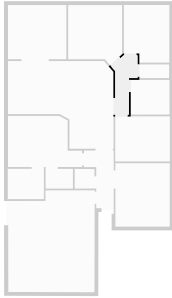

▼ Bedroom Ground Floor

WIDTH: 3.60 m • LENGTH: 2.97 m
AREA: 10.69 m² • PERIMETER: 13.14 m

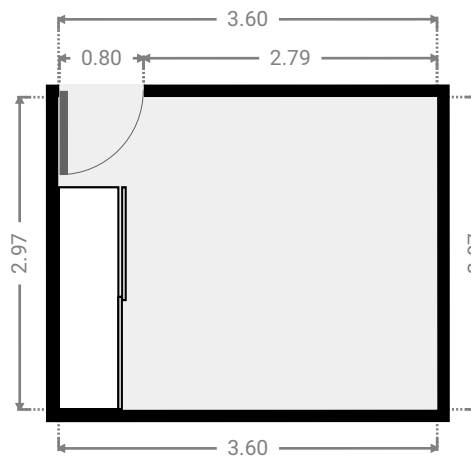
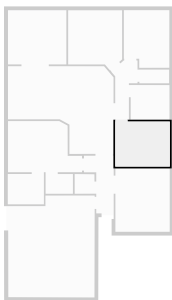

▼ Bathroom Ground Floor

WIDTH: 2.56 m • LENGTH: 2.29 m
AREA: 5.84 m² • PERIMETER: 9.68 m

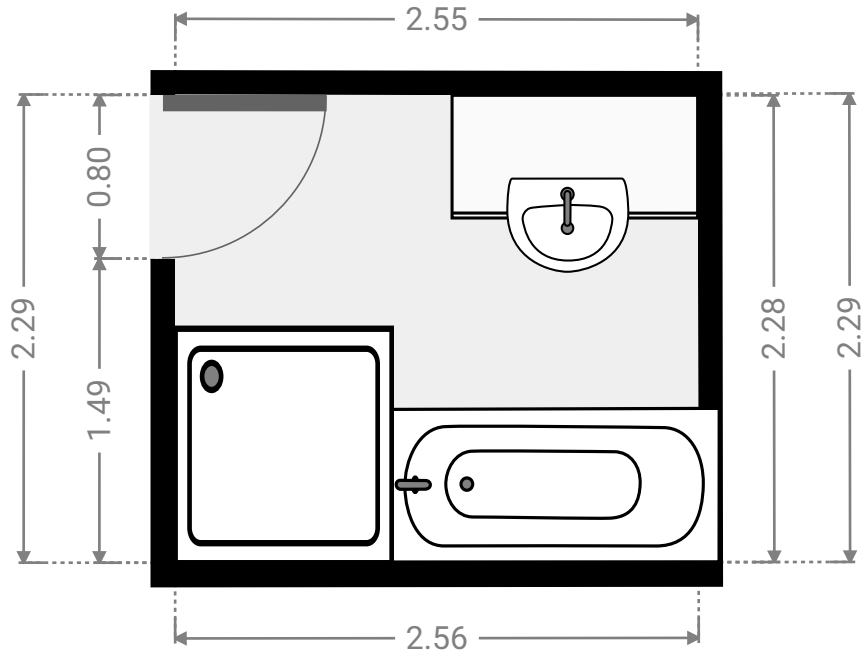
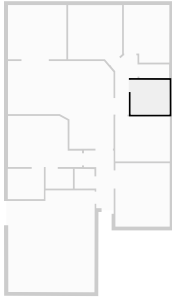

▼ Toilet Ground Floor

WIDTH: 1.96 m • LENGTH: 0.90 m
AREA: 1.76 m² • PERIMETER: 5.72 m

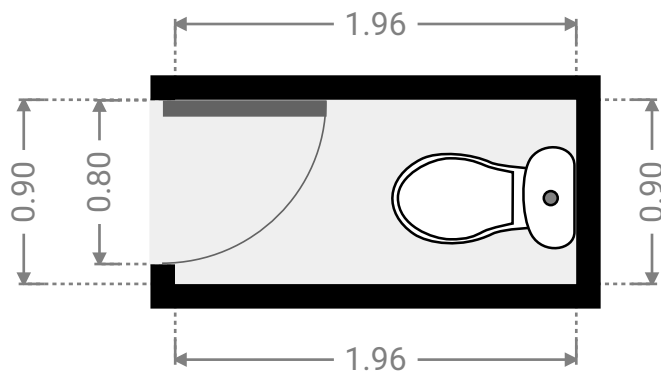
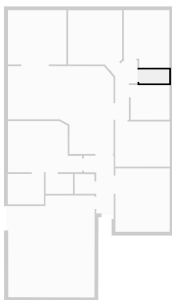

▼ Bedroom Ground Floor

WIDTH: 3.00 m • LENGTH: 3.80 m
AREA: 10.78 m² • PERIMETER: 13.59 m

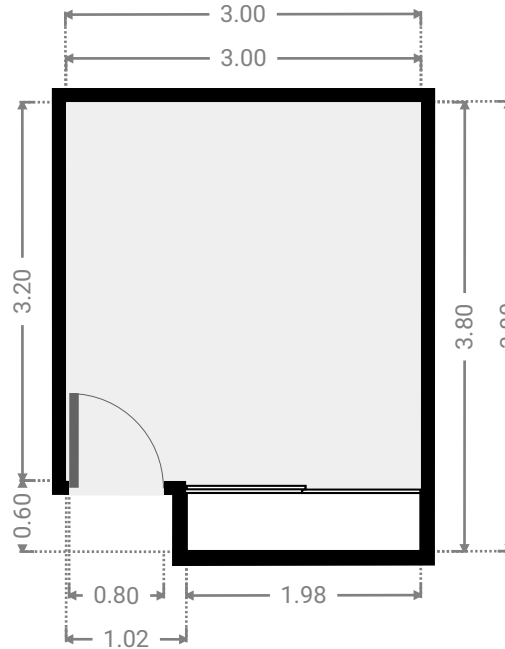
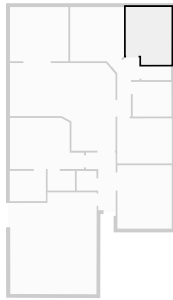

▼ Bedroom Ground Floor

WIDTH: 3.58 m • LENGTH: 3.96 m
AREA: 12.79 m² • PERIMETER: 14.37 m

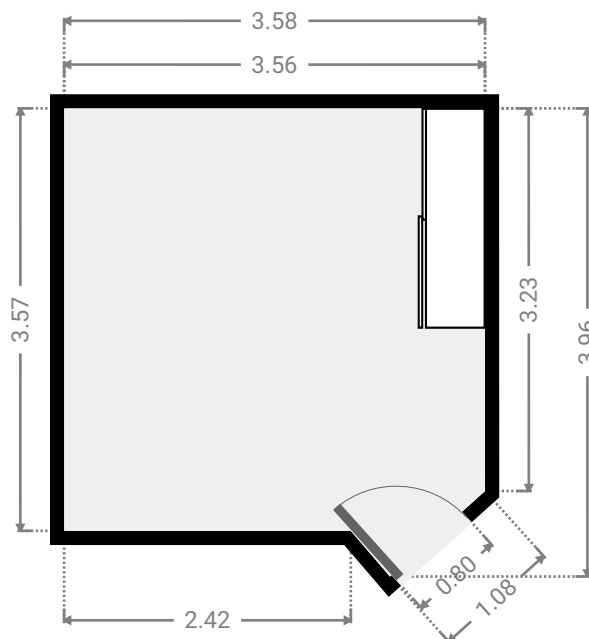
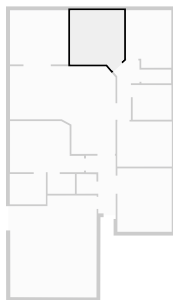

▼ Patio Ground Floor

WIDTH: 3.85 m • LENGTH: 3.57 m
AREA: 13.74 m² • PERIMETER: 14.84 m

