

2/5 Wigginton Street

Ground Floor

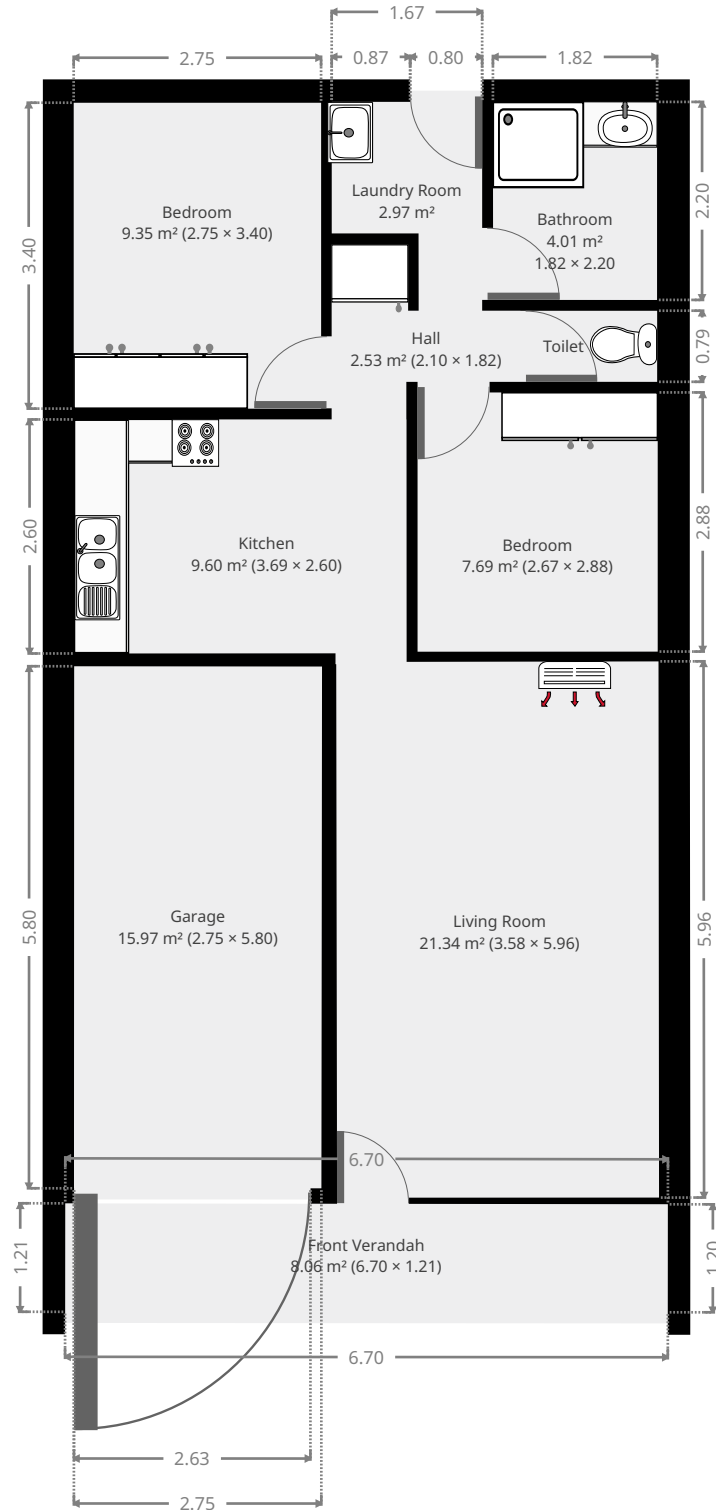

THIS FLOORPLAN IS PROVIDED WITHOUT WARRANTY OF ANY KIND. SENSOPIA DISCLAIMS ANY WARRANTY INCLUDING, WITHOUT LIMITATION, SATISFACTORY QUALITY OR ACCURACY OF DIMENSIONS.



2/5 Wigginton Street

Living Room

Width: 3.58 m
Length: 5.96 m
Area: 21.34 m²
Perimeter: 19.08 m

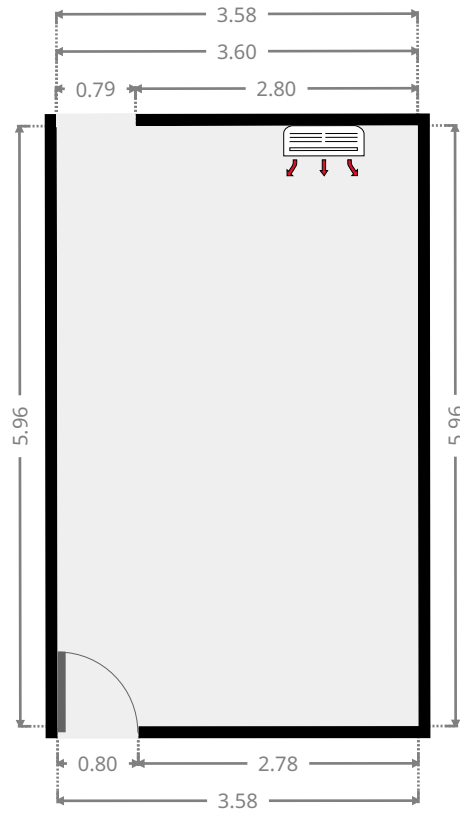
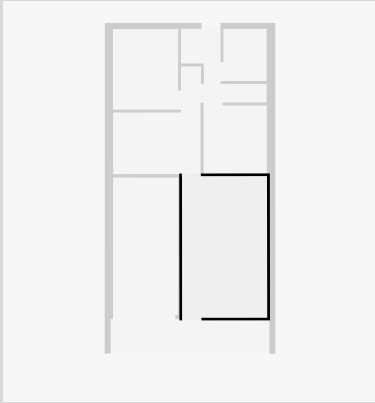

Kitchen

Width: 2.60 m
Length: 3.69 m
Area: 9.60 m²
Perimeter: 12.58 m

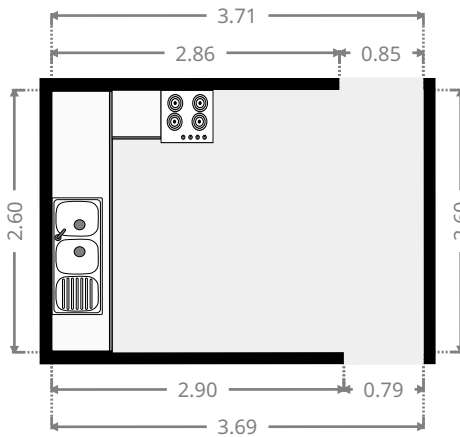

2/5 Wigginton Street

Hall

Width: 1.82 m
 Length: 2.10 m
 Area: 2.53 m²
 Perimeter: 7.84 m

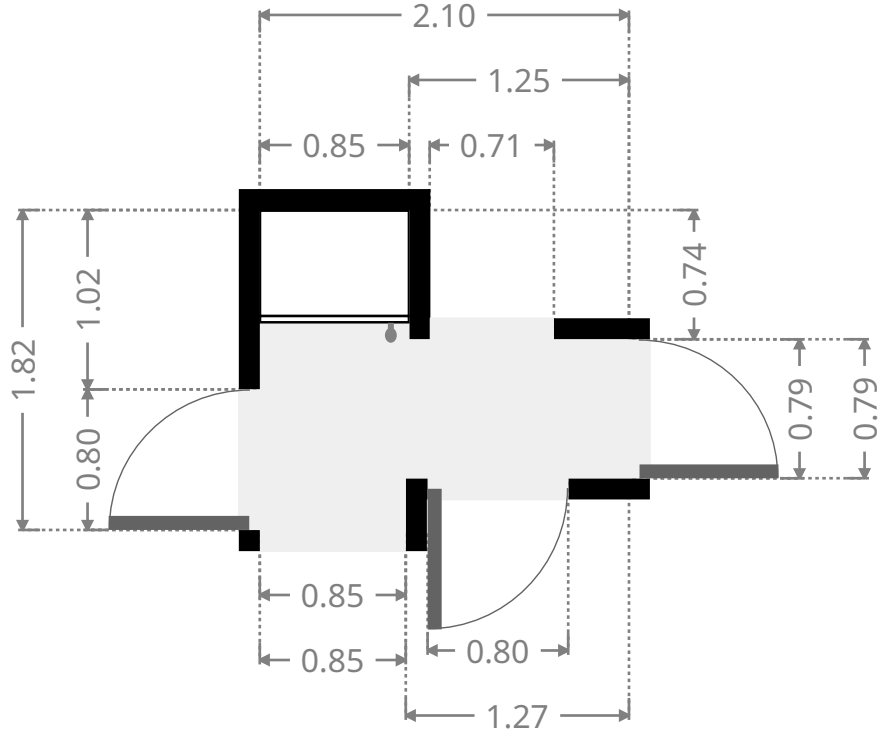
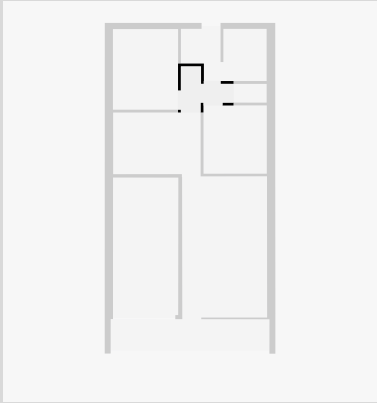

Bedroom

Width: 2.75 m
 Length: 3.40 m
 Area: 9.35 m²
 Perimeter: 12.30 m

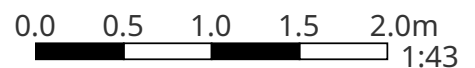
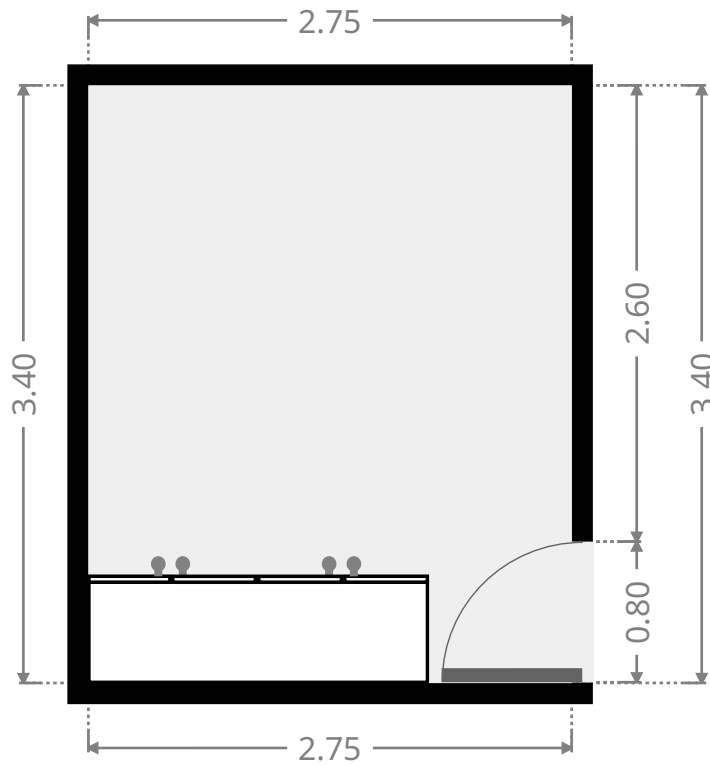
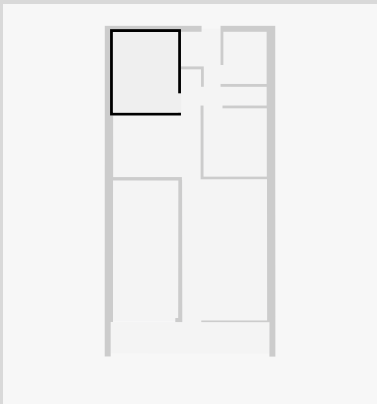

THIS FLOORPLAN IS PROVIDED WITHOUT WARRANTY OF ANY KIND. SENSOPIA DISCLAIMS ANY WARRANTY INCLUDING, WITHOUT LIMITATION, SATISFACTORY QUALITY OR ACCURACY OF DIMENSIONS.

2/5 Wigginton Street

Bedroom

Width: 2.67 m
Length: 2.88 m
Area: 7.69 m²
Perimeter: 11.10 m

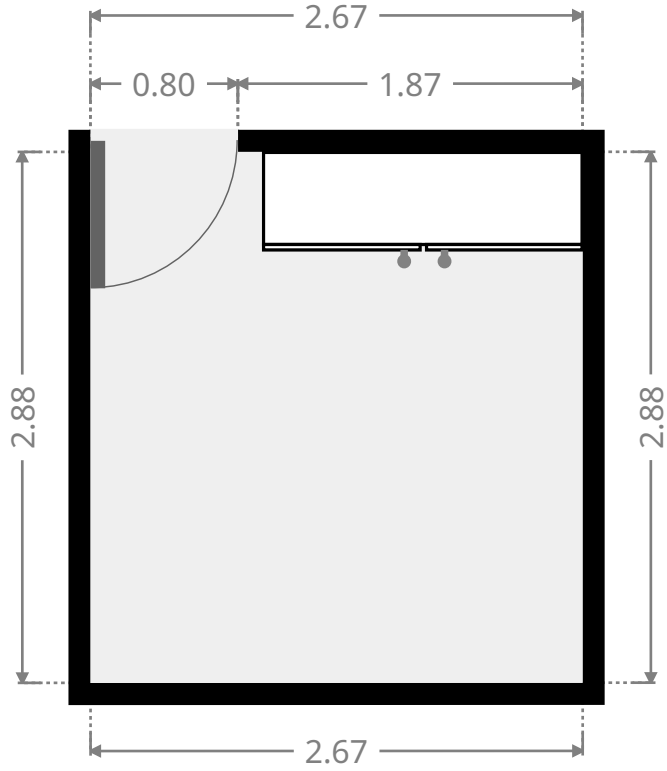
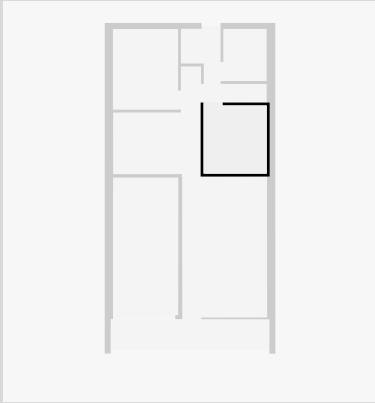

Toilet / Half Bath

Width: 0.79 m
Length: 1.40 m
Area: 1.10 m²
Perimeter: 4.38 m

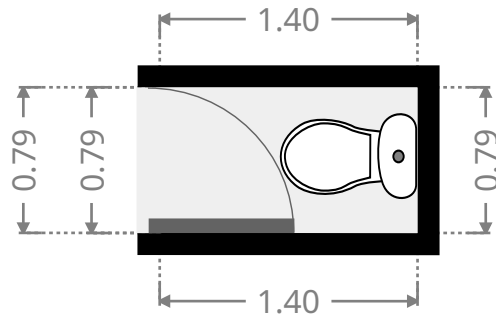
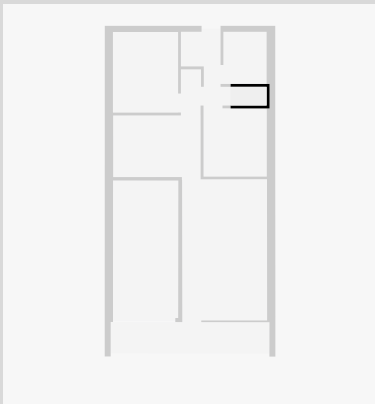

2/5 Wigginton Street

Laundry Room

Width: 1.67 m
Length: 2.20 m
Area: 2.97 m²
Perimeter: 7.75 m

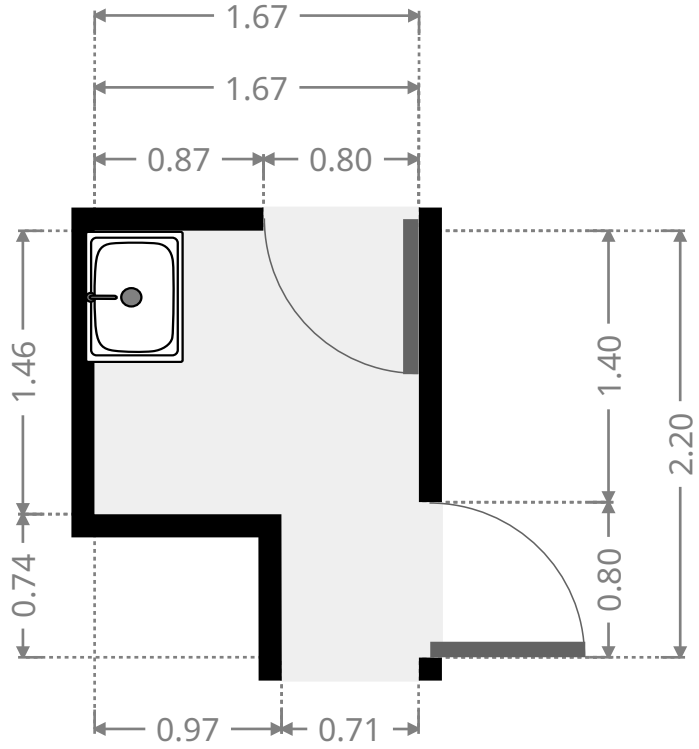
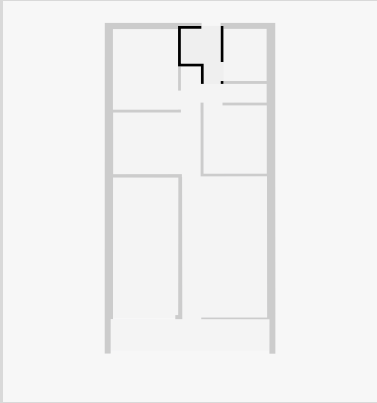

Bathroom

Width: 1.82 m
Length: 2.20 m
Area: 4.01 m²
Perimeter: 8.05 m

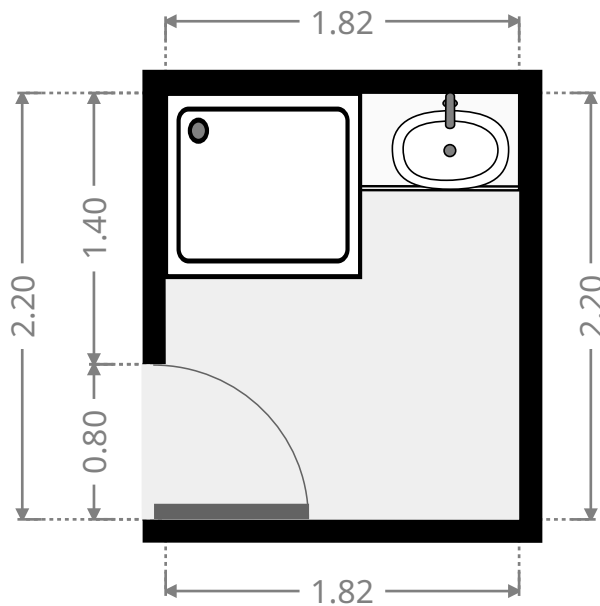
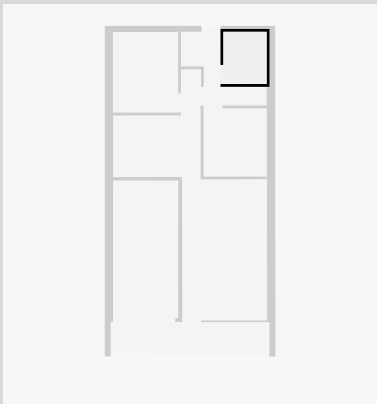

2/5 Wigginton Street

Garage

Width: 2.75 m
Length: 5.80 m
Area: 15.97 m²
Perimeter: 17.11 m

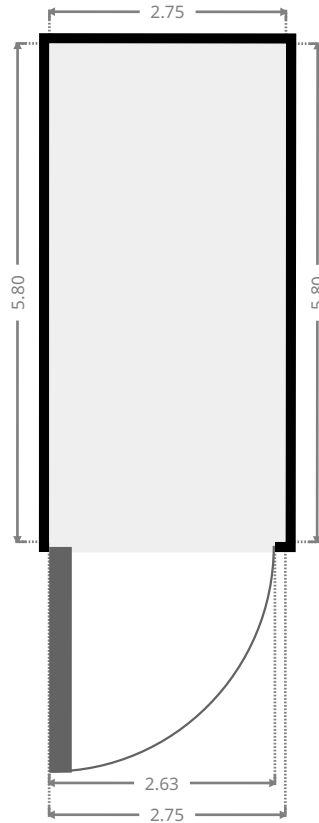
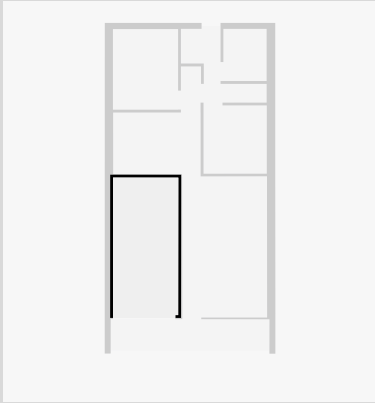

Front Verandah

Width: 1.21 m
Length: 6.70 m
Area: 8.06 m²
Perimeter: 15.80 m

