

# 2/22 Victoria Parade

Created on  
2020-10-15

Floors

1

▼ Ground Floor

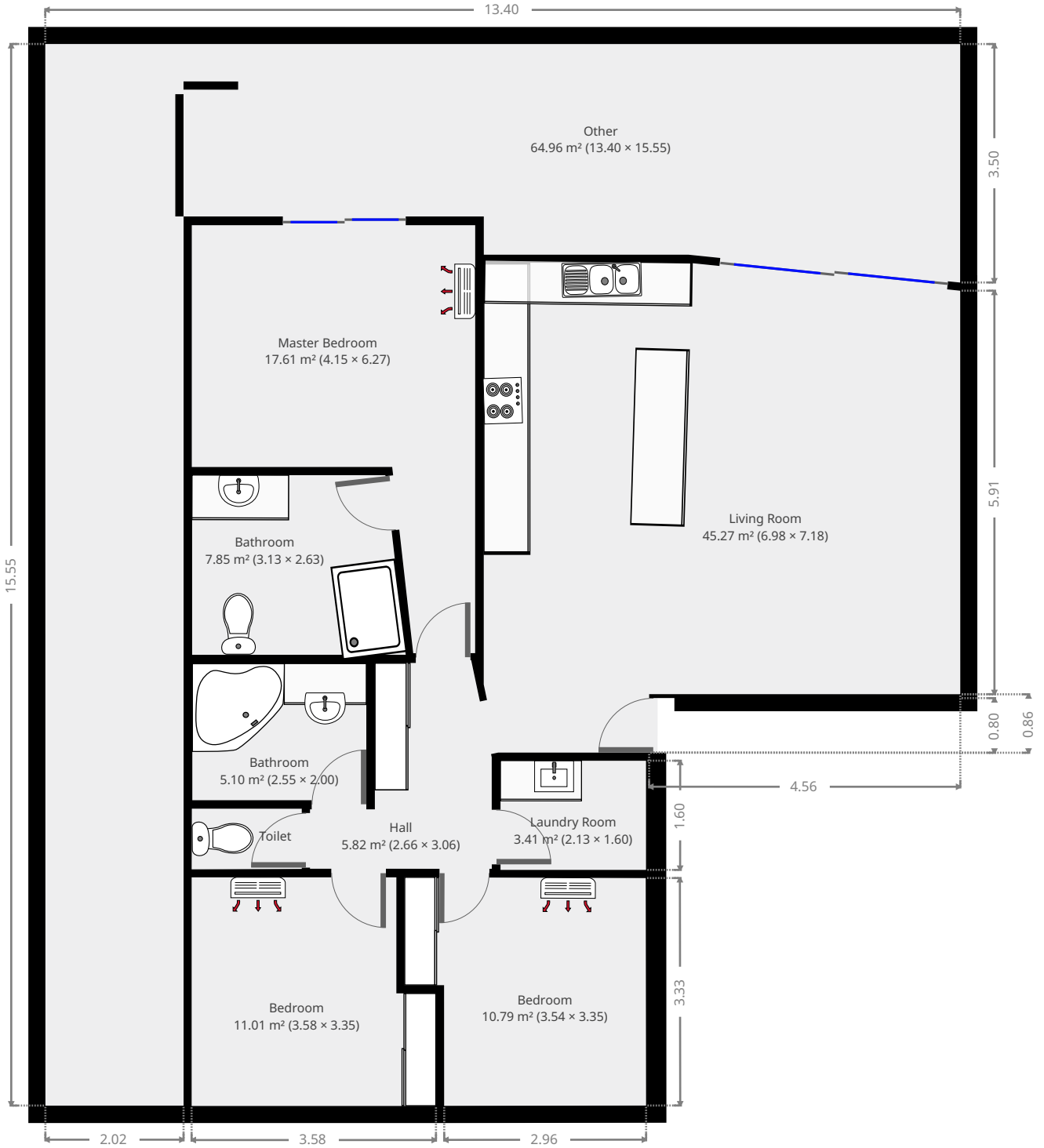

THIS FLOORPLAN IS PROVIDED WITHOUT WARRANTY OF ANY KIND. SENSOPIA DISCLAIMS ANY WARRANTY INCLUDING, WITHOUT LIMITATION, SATISFACTORY QUALITY OR ACCURACY OF DIMENSIONS.

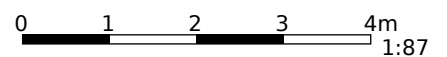

FLOORS: 1

▼ **Living Room**  
Ground Floor

**WIDTH:** 6.98 m • **LENGTH:** 7.18 m  
**AREA:** 45.27 m<sup>2</sup> • **PERIMETER:** 27.74 m

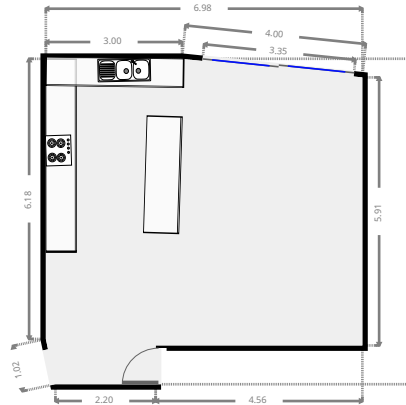
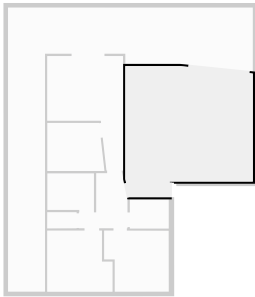

▼ **Other**  
Ground Floor

**WIDTH:** 13.40 m • **LENGTH:** 15.55 m  
**AREA:** 64.96 m<sup>2</sup> • **PERIMETER:** 59.46 m

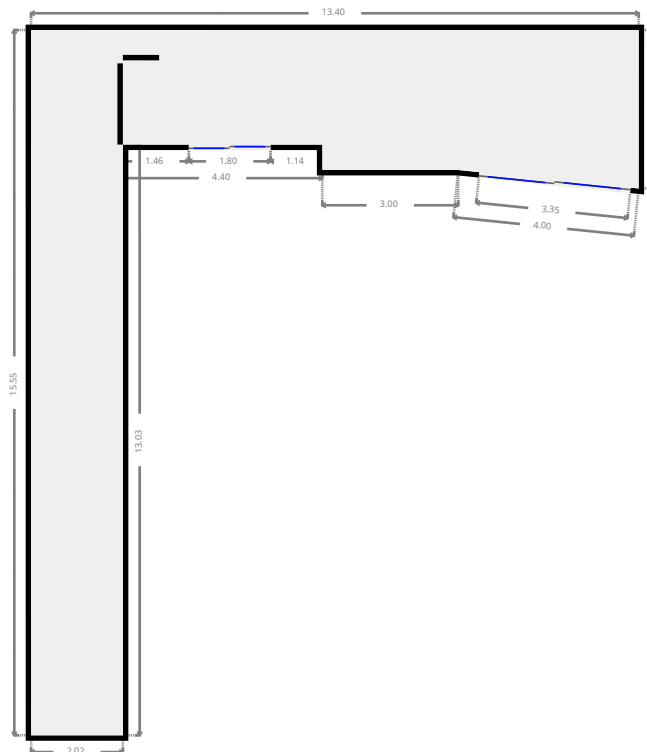
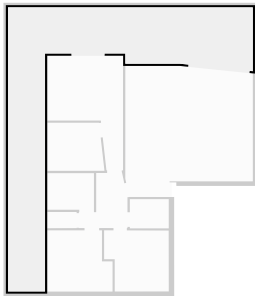

FLOORS: 1

▼ **Hall**  
Ground Floor

**WIDTH:** 2.66 m • **LENGTH:** 3.06 m  
**AREA:** 5.82 m<sup>2</sup> • **PERIMETER:** 11.17 m

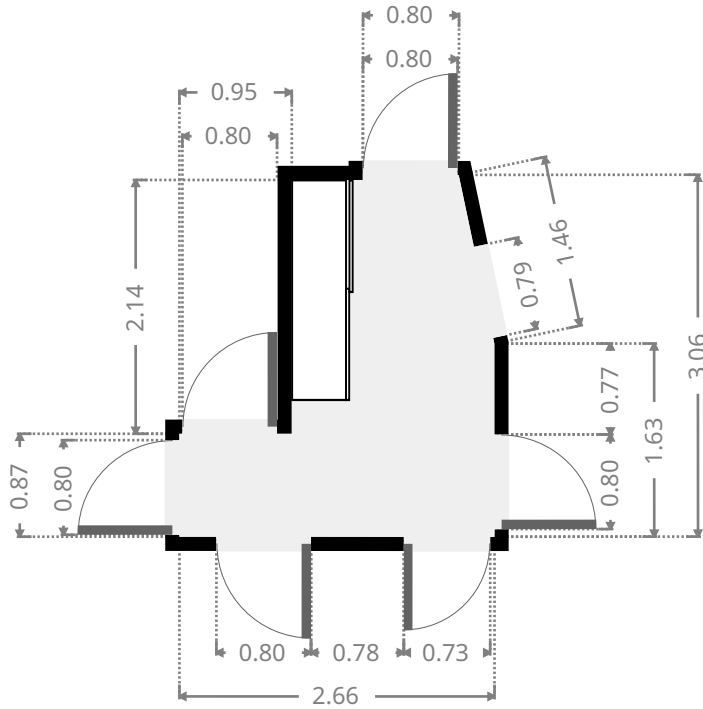
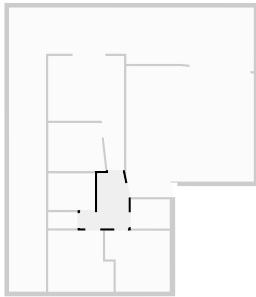

▼ **Laundry Room**  
Ground Floor

**WIDTH:** 2.13 m • **LENGTH:** 1.60 m  
**AREA:** 3.41 m<sup>2</sup> • **PERIMETER:** 7.46 m

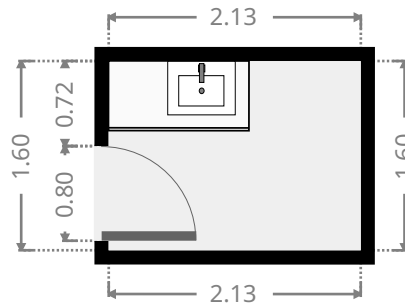
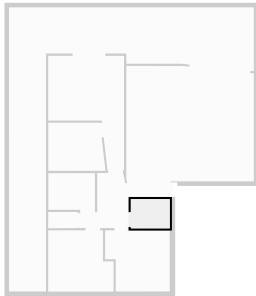

▼ **Master Bedroom**  
Ground Floor

**WIDTH:** 4.15 m • **LENGTH:** 6.27 m  
**AREA:** 17.61 m<sup>2</sup> • **PERIMETER:** 20.56 m

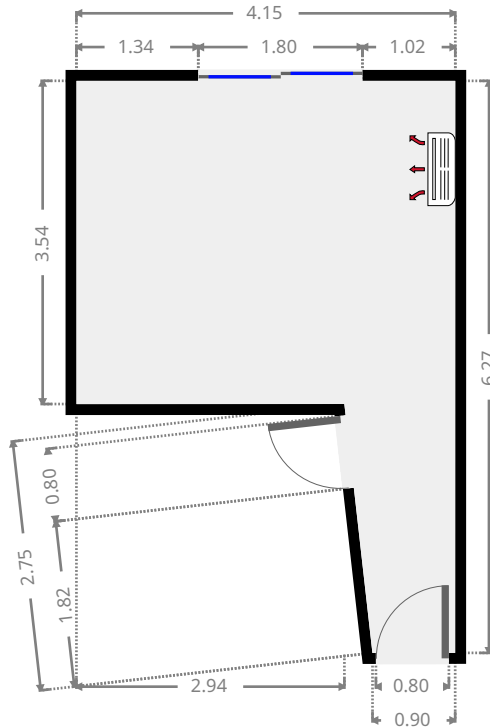
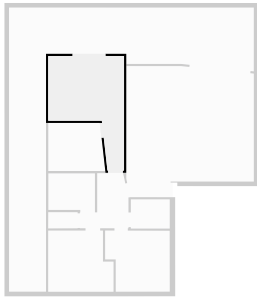

▼ **Bathroom**  
Ground Floor

**WIDTH:** 3.13 m • **LENGTH:** 2.63 m  
**AREA:** 7.85 m<sup>2</sup> • **PERIMETER:** 11.24 m

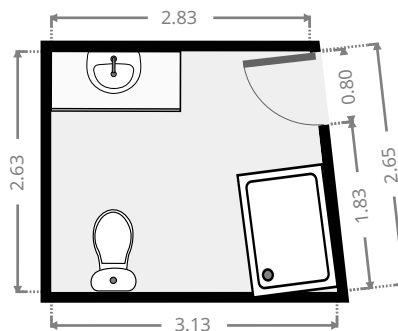
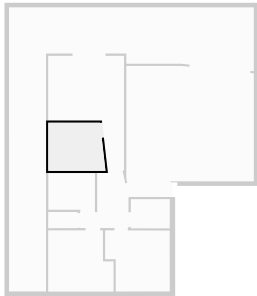

FLOORS: 1

▼ **Bathroom**  
Ground Floor

WIDTH: 2.55 m • LENGTH: 2.00 m  
AREA: 5.10 m<sup>2</sup> • PERIMETER: 9.10 m

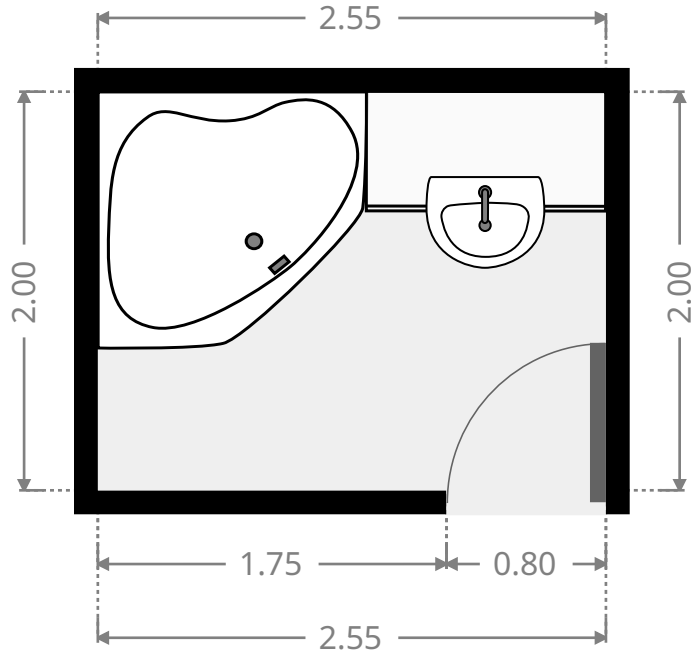
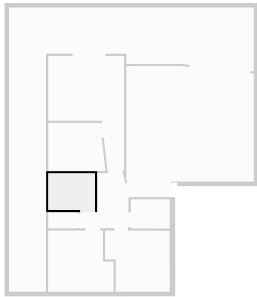

▼ **Toilet**  
Ground Floor

WIDTH: 1.62 m • LENGTH: 0.89 m  
AREA: 1.43 m<sup>2</sup> • PERIMETER: 5.00 m

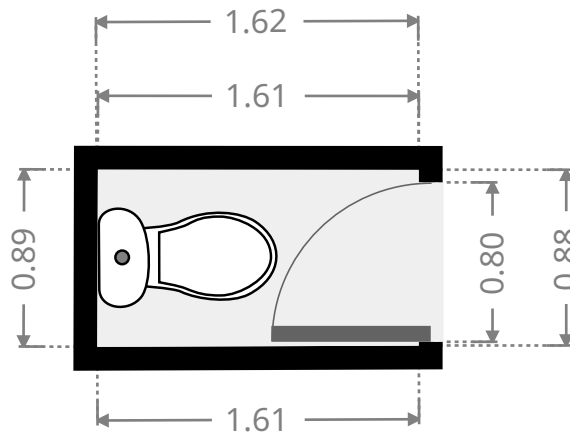
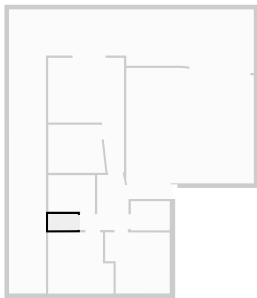

FLOORS: 1

▼ **Bedroom**  
Ground Floor

WIDTH: 3.58 m • LENGTH: 3.35 m  
AREA: 11.01 m<sup>2</sup> • PERIMETER: 13.86 m

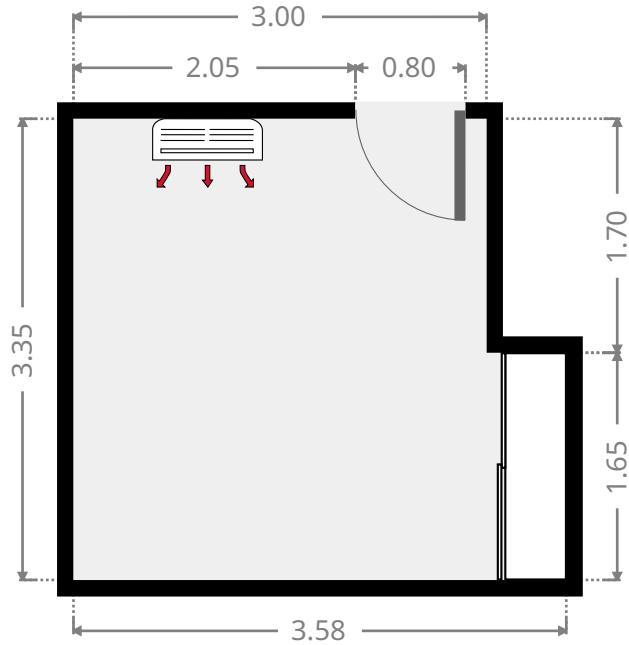
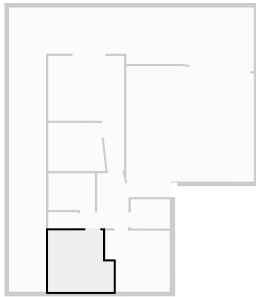

▼ **Bedroom**  
Ground Floor

WIDTH: 3.54 m • LENGTH: 3.35 m  
AREA: 10.79 m<sup>2</sup> • PERIMETER: 13.75 m

