

# Ground Floor

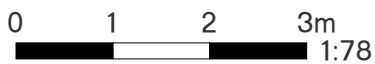
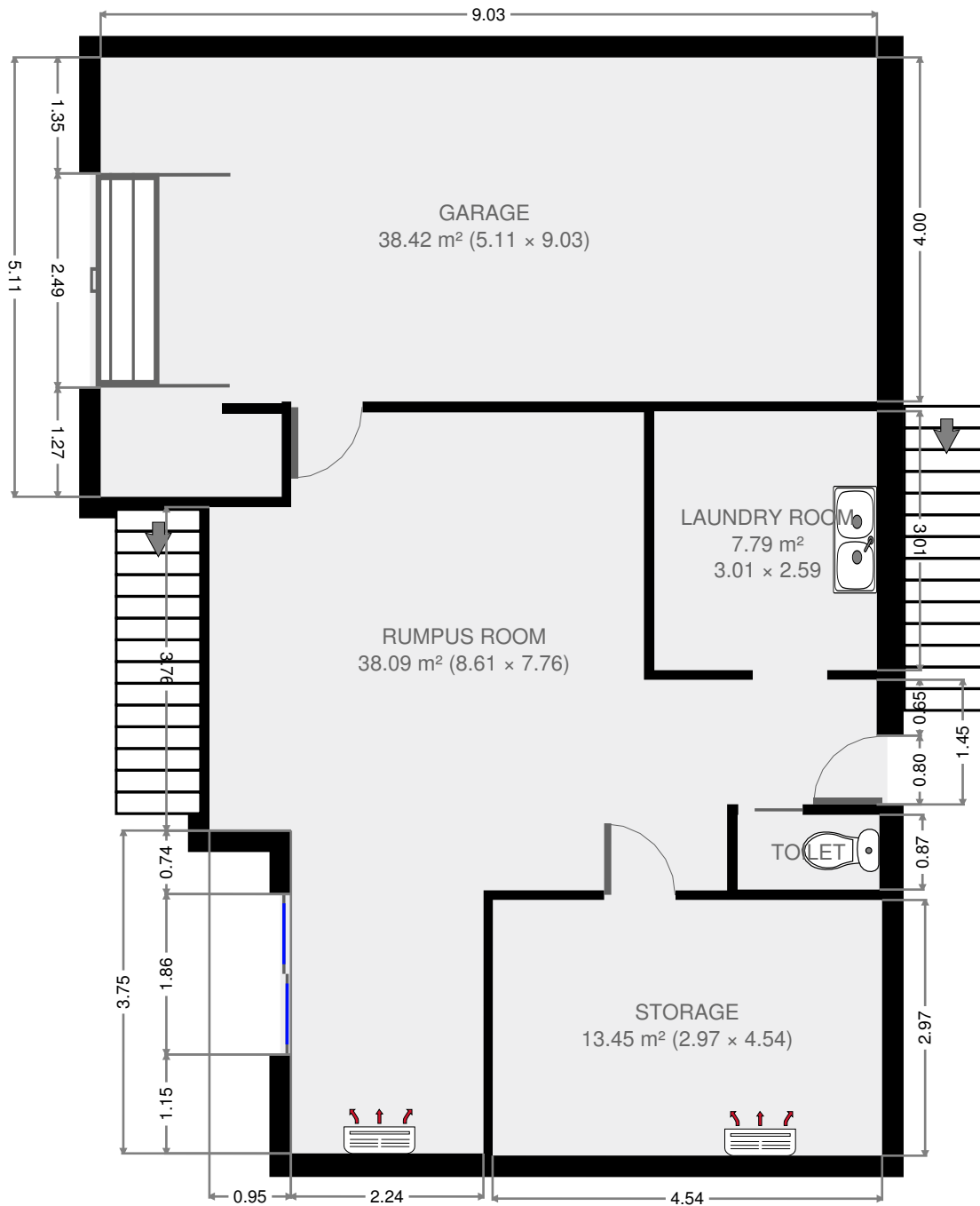

THIS FLOORPLAN IS PROVIDED WITHOUT WARRANTY OF ANY KIND. SENSOPIA DISCLAIMS ANY WARRANTY INCLUDING, WITHOUT LIMITATION, SATISFACTORY QUALITY OR ACCURACY OF DIMENSIONS.

## 199 Wilson Street

# Rumpus Room

Width: 7.76 m  
 Length: 8.61 m  
 Area: 38.09 m<sup>2</sup>  
 Perimeter: 32.75 m  
 Ceiling Height: 2.17 m

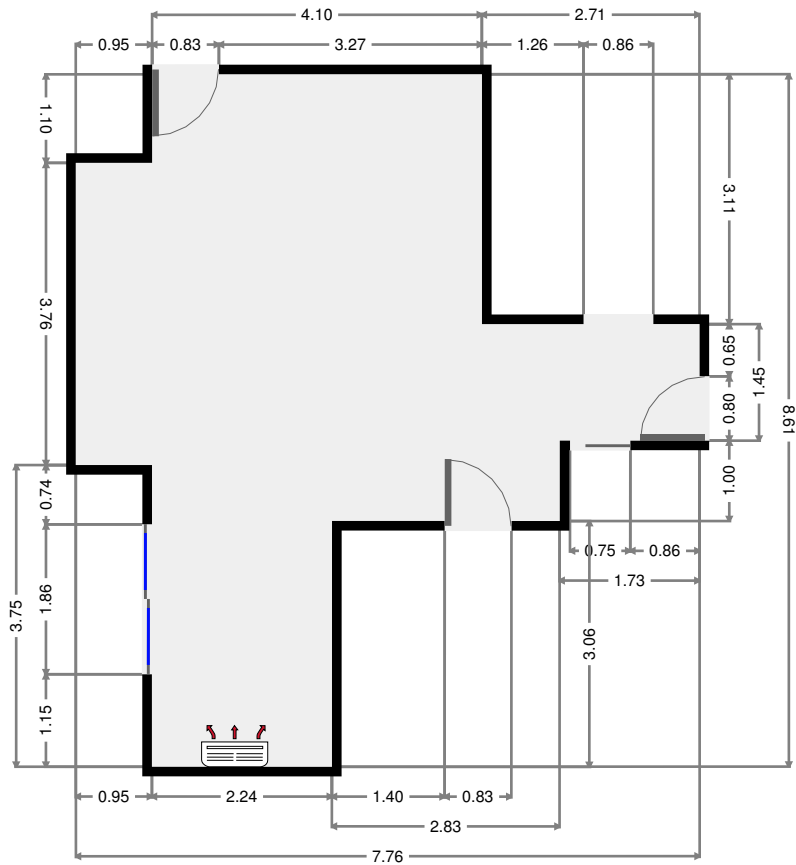
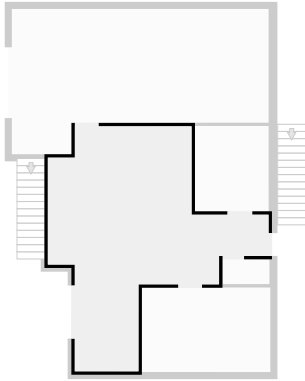

# Storage

Width: 2.97 m  
 Length: 4.54 m  
 Area: 13.45 m<sup>2</sup>  
 Perimeter: 15.00 m

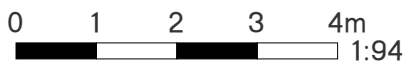
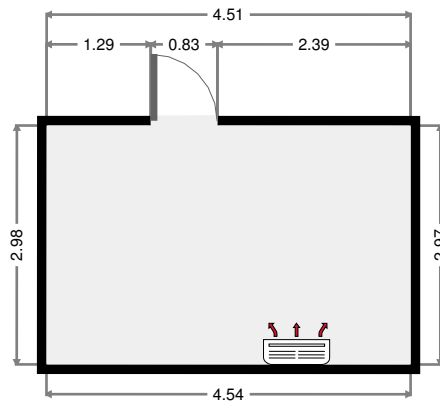
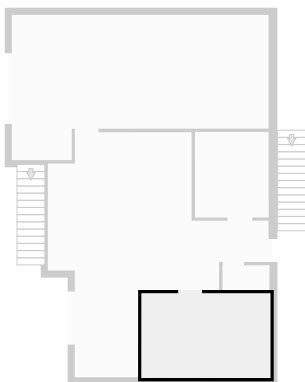

THIS FLOORPLAN IS PROVIDED WITHOUT WARRANTY OF ANY KIND. SENSOPIA DISCLAIMS ANY WARRANTY INCLUDING, WITHOUT LIMITATION, SATISFACTORY QUALITY OR ACCURACY OF DIMENSIONS.

# Toilet

Width: 0.87 m  
 Length: 1.65 m  
 Area: 1.43 m<sup>2</sup>  
 Perimeter: 5.04 m

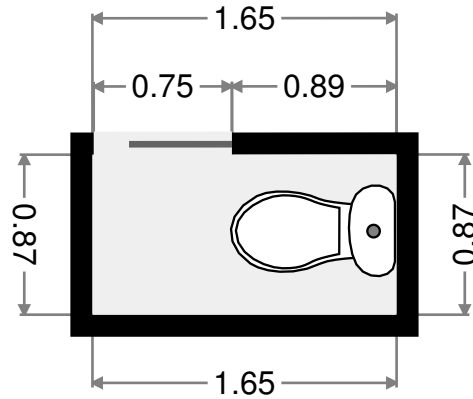
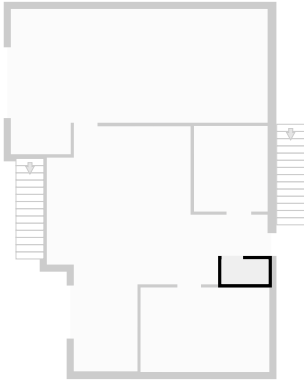

# Laundry Room

Width: 2.59 m  
 Length: 3.01 m  
 Area: 7.79 m<sup>2</sup>  
 Perimeter: 11.20 m

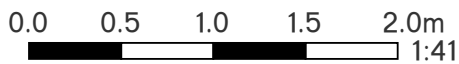
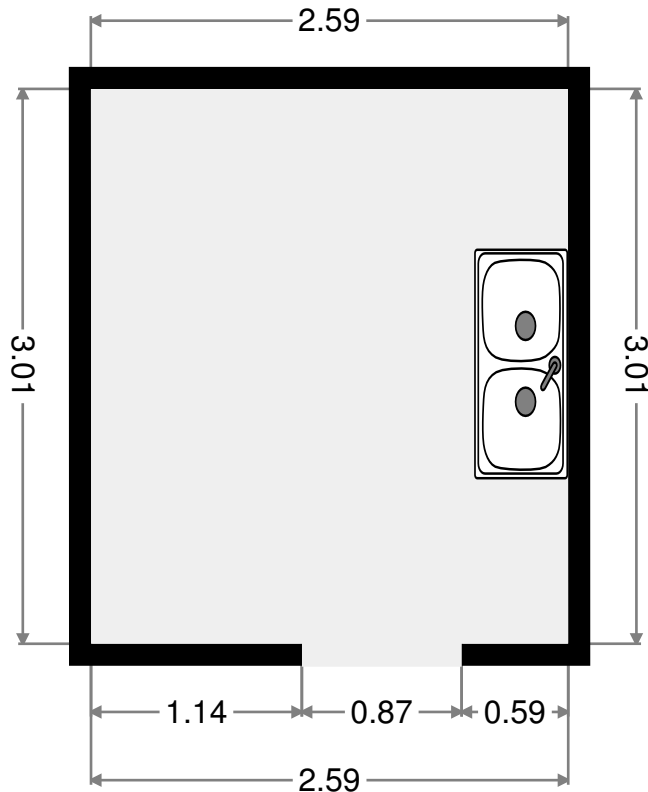
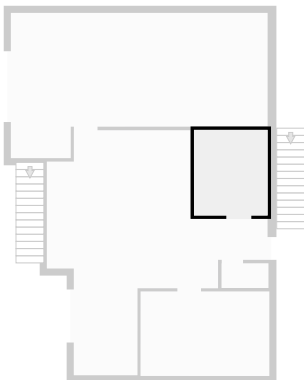

THIS FLOORPLAN IS PROVIDED WITHOUT WARRANTY OF ANY KIND. SENSOPIA DISCLAIMS ANY WARRANTY INCLUDING, WITHOUT LIMITATION, SATISFACTORY QUALITY OR ACCURACY OF DIMENSIONS.

# Garage

Width: 5.11 m  
Length: 9.03 m  
Area: 38.42 m<sup>2</sup>  
Perimeter: 28.26 m

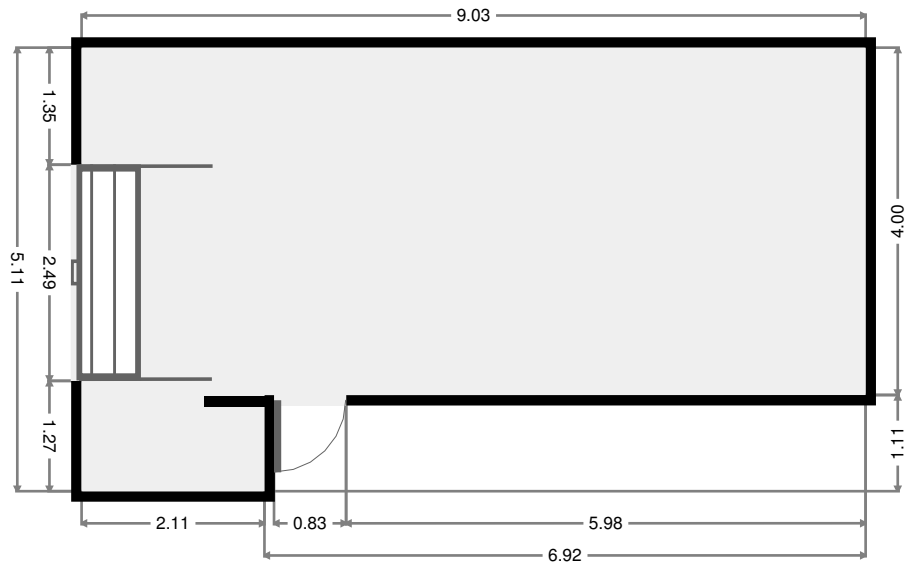
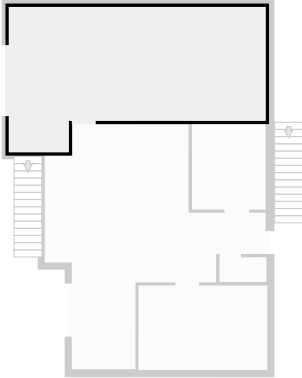

THIS FLOORPLAN IS PROVIDED WITHOUT WARRANTY OF ANY KIND. SENSOPIA DISCLAIMS ANY WARRANTY INCLUDING, WITHOUT LIMITATION, SATISFACTORY QUALITY OR ACCURACY OF DIMENSIONS.

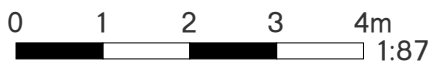

199 Wilson Street

2017-04-04

# 1st Floor

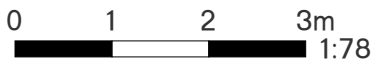
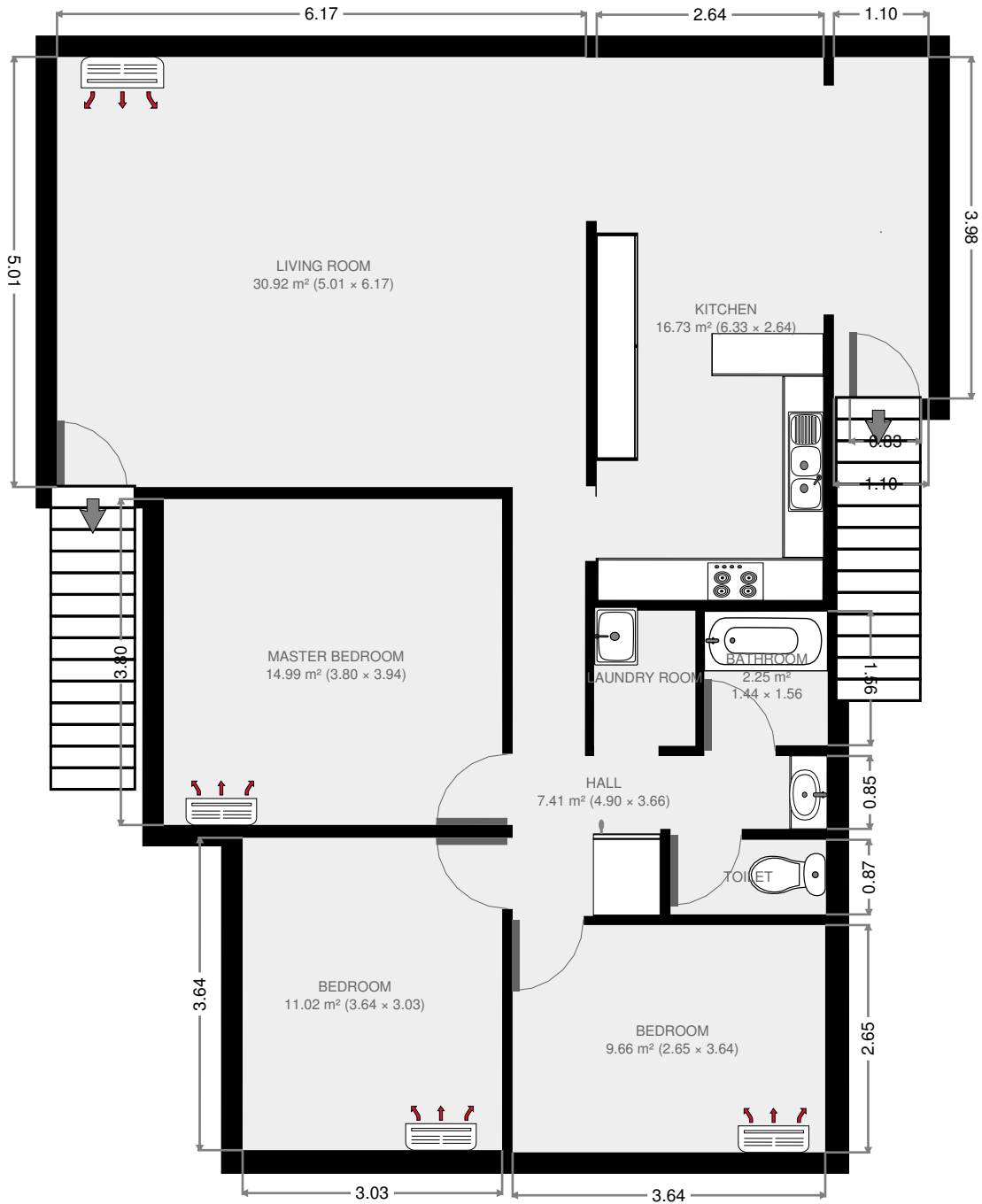

THIS FLOORPLAN IS PROVIDED WITHOUT WARRANTY OF ANY KIND. SENSOPIA DISCLAIMS ANY WARRANTY INCLUDING, WITHOUT LIMITATION, SATISFACTORY QUALITY OR ACCURACY OF DIMENSIONS.

## 199 Wilson Street

# Living Room

Width: 5.01 m  
 Length: 6.17 m  
 Area: 30.92 m<sup>2</sup>  
 Perimeter: 22.36 m

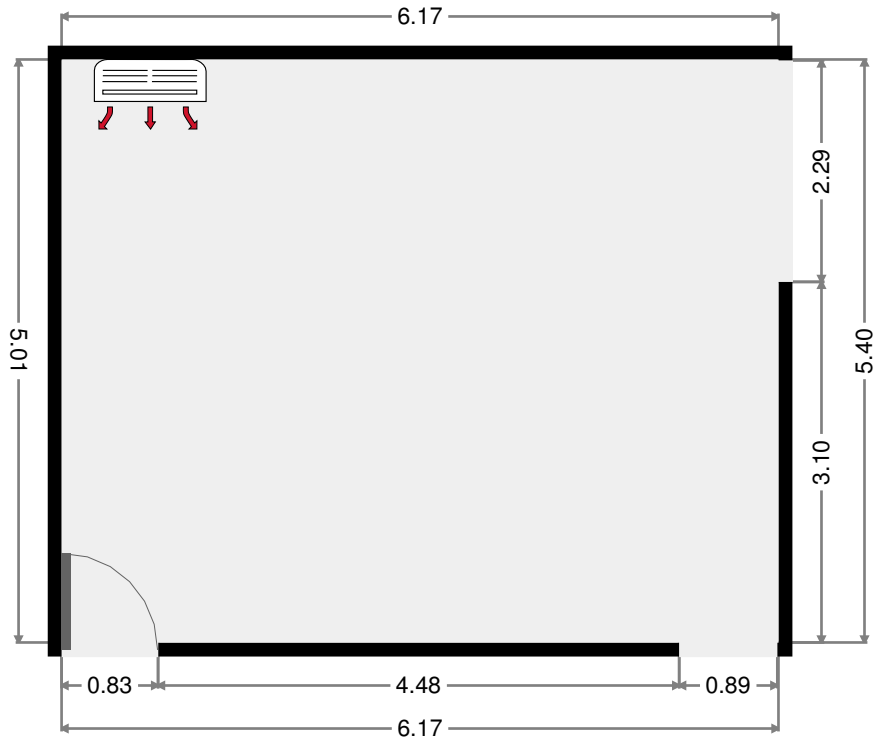
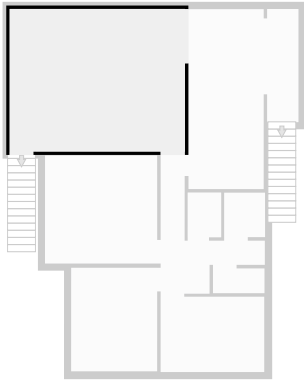

# Kitchen

Width: 2.64 m  
 Length: 6.33 m  
 Area: 16.73 m<sup>2</sup>  
 Perimeter: 17.94 m

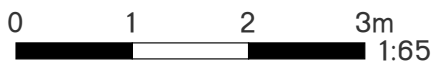
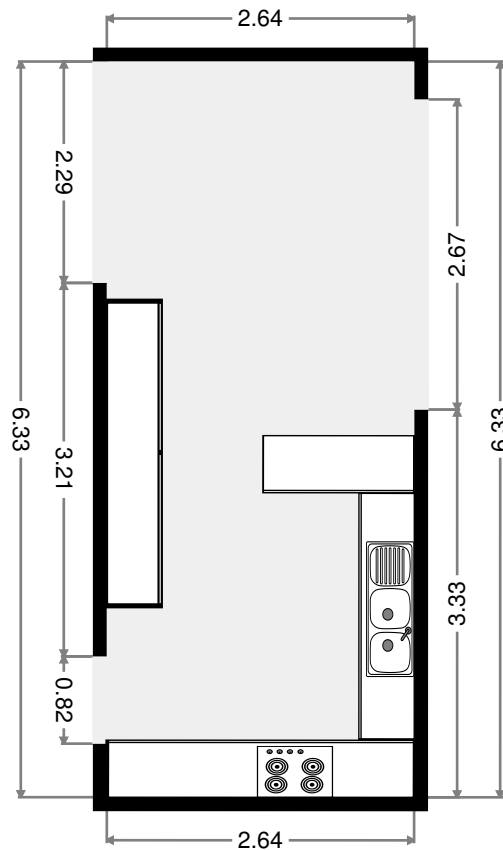
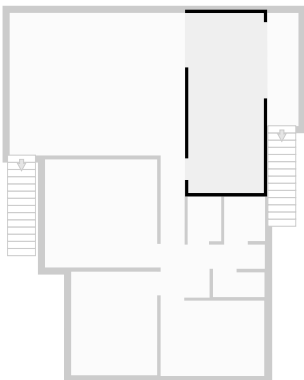

THIS FLOORPLAN IS PROVIDED WITHOUT WARRANTY OF ANY KIND. SENSOPIA DISCLAIMS ANY WARRANTY INCLUDING, WITHOUT LIMITATION, SATISFACTORY QUALITY OR ACCURACY OF DIMENSIONS.

•  
 Width: 1.10 m  
 Length: 3.98 m  
 Area: 4.39 m<sup>2</sup>  
 Perimeter: 10.16 m

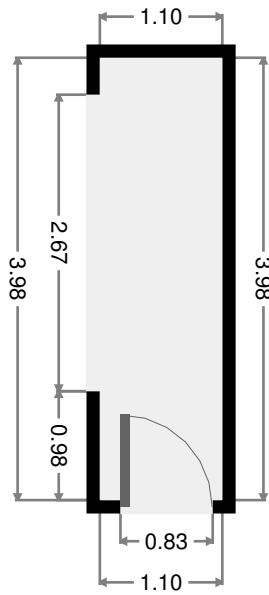

# Hall

Width: 3.66 m  
 Length: 4.90 m  
 Area: 7.41 m<sup>2</sup>  
 Perimeter: 17.11 m

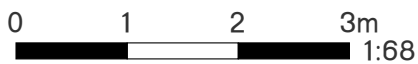
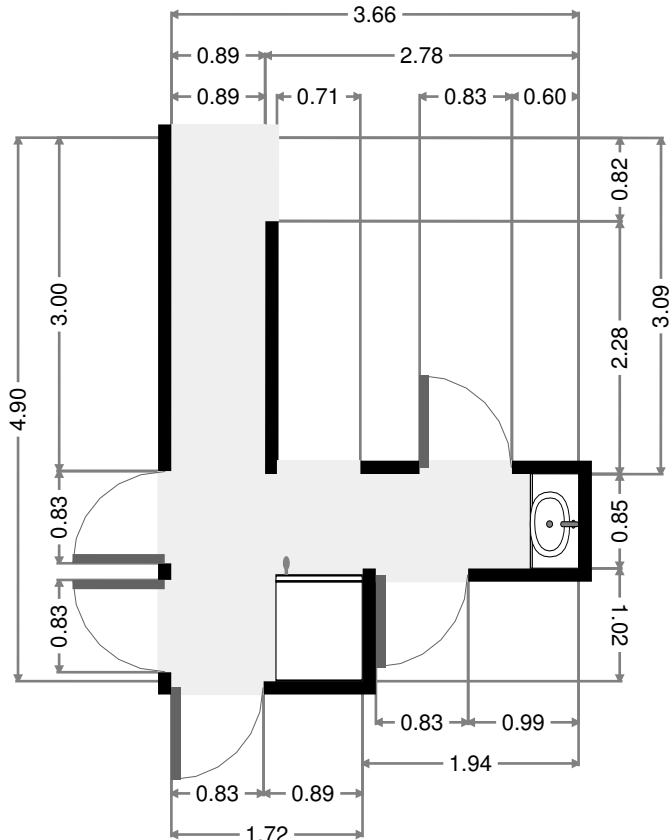
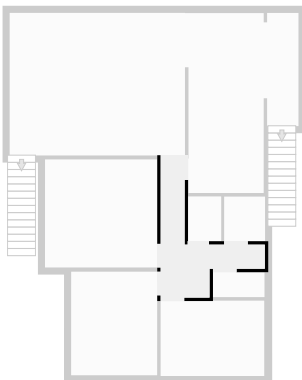

THIS FLOORPLAN IS PROVIDED WITHOUT WARRANTY OF ANY KIND. SENSOPIA DISCLAIMS ANY WARRANTY INCLUDING, WITHOUT LIMITATION, SATISFACTORY QUALITY OR ACCURACY OF DIMENSIONS.

# Laundry Room

Width: 1.19 m  
 Length: 1.58 m  
 Area: 1.86 m<sup>2</sup>  
 Perimeter: 5.51 m

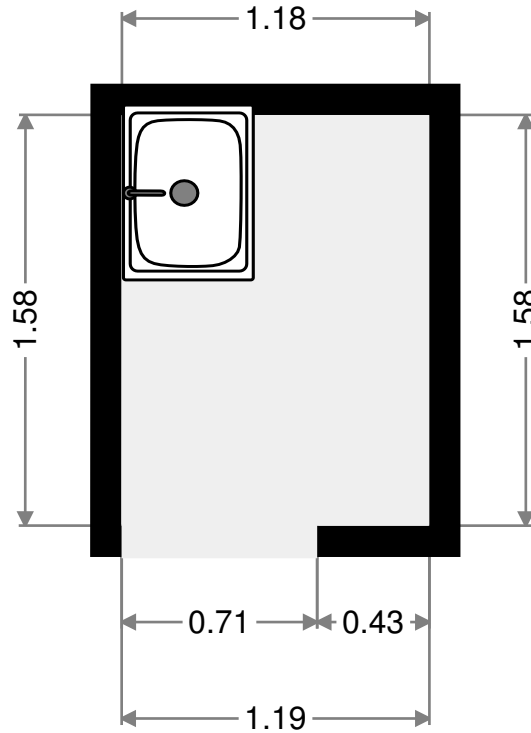
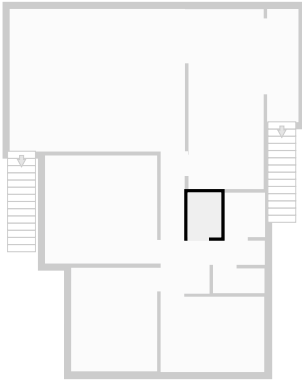

# Bathroom

Width: 1.44 m  
 Length: 1.56 m  
 Area: 2.25 m<sup>2</sup>  
 Perimeter: 6.01 m

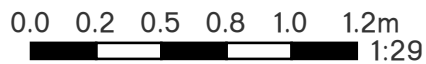
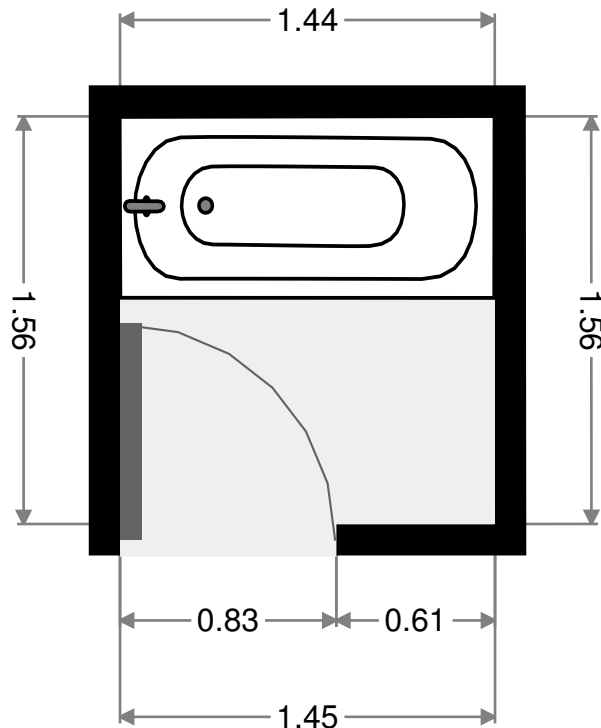
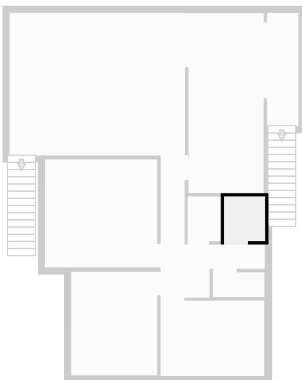

THIS FLOORPLAN IS PROVIDED WITHOUT WARRANTY OF ANY KIND. SENSOPIA DISCLAIMS ANY WARRANTY INCLUDING, WITHOUT LIMITATION, SATISFACTORY QUALITY OR ACCURACY OF DIMENSIONS.



# Toilet

Width: 0.87 m  
Length: 1.81 m  
Area: 1.58 m<sup>2</sup>  
Perimeter: 5.36 m

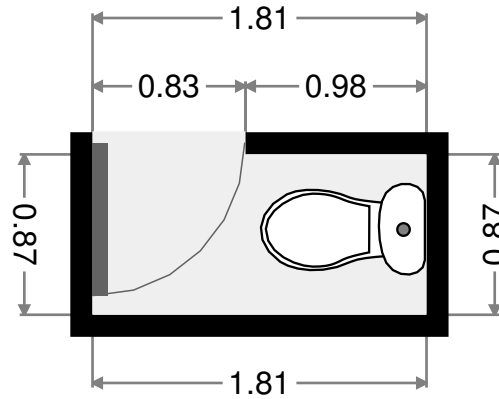
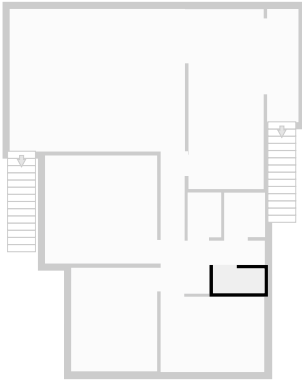

# Bedroom

Width: 2.65 m  
Length: 3.64 m  
Area: 9.66 m<sup>2</sup>  
Perimeter: 12.59 m

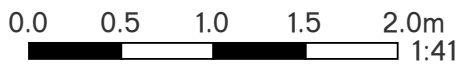
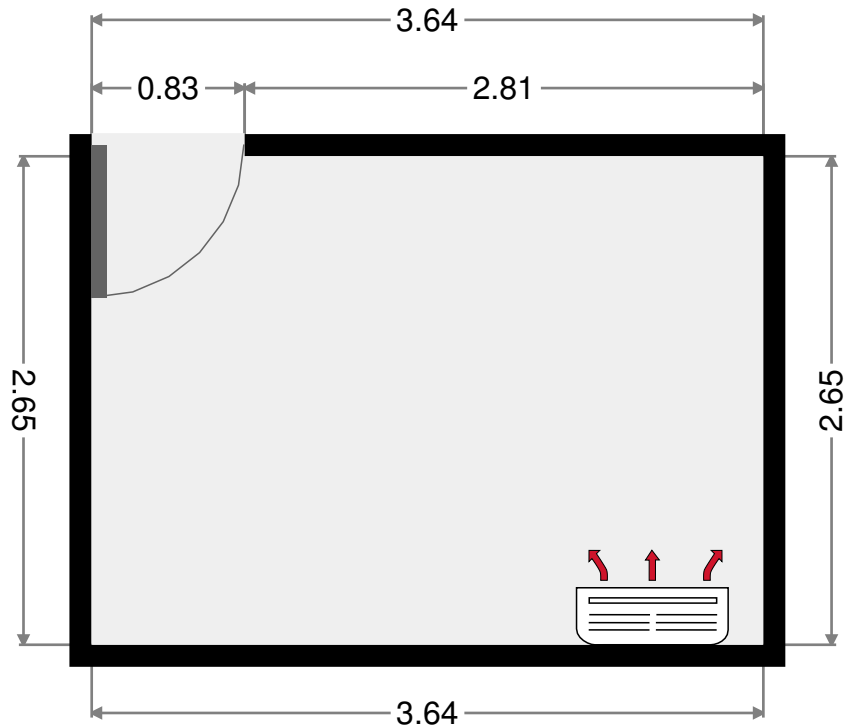
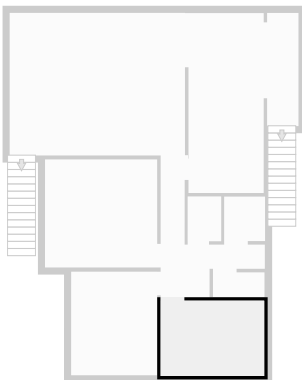

THIS FLOORPLAN IS PROVIDED WITHOUT WARRANTY OF ANY KIND. SENSOPIA DISCLAIMS ANY WARRANTY INCLUDING, WITHOUT LIMITATION, SATISFACTORY QUALITY OR ACCURACY OF DIMENSIONS.

# Bedroom

Width: 3.03 m  
 Length: 3.64 m  
 Area: 11.02 m<sup>2</sup>  
 Perimeter: 13.33 m

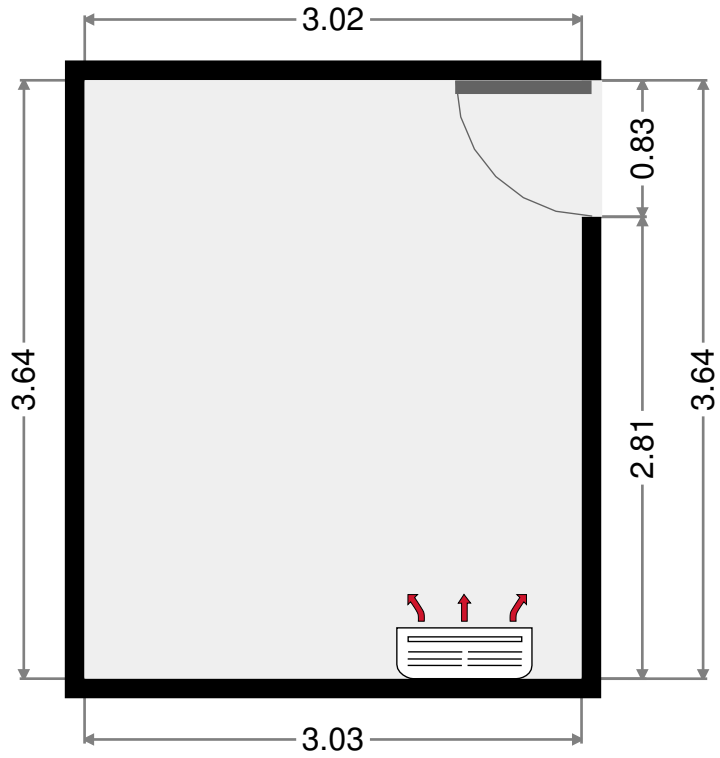
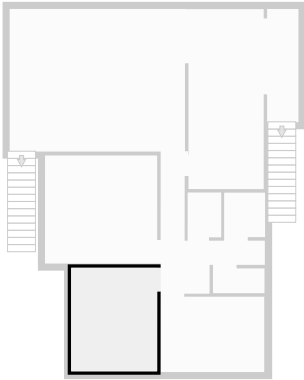

# Master Bedroom

Width: 3.80 m  
 Length: 3.94 m  
 Area: 14.99 m<sup>2</sup>  
 Perimeter: 15.49 m

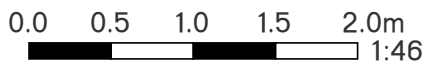
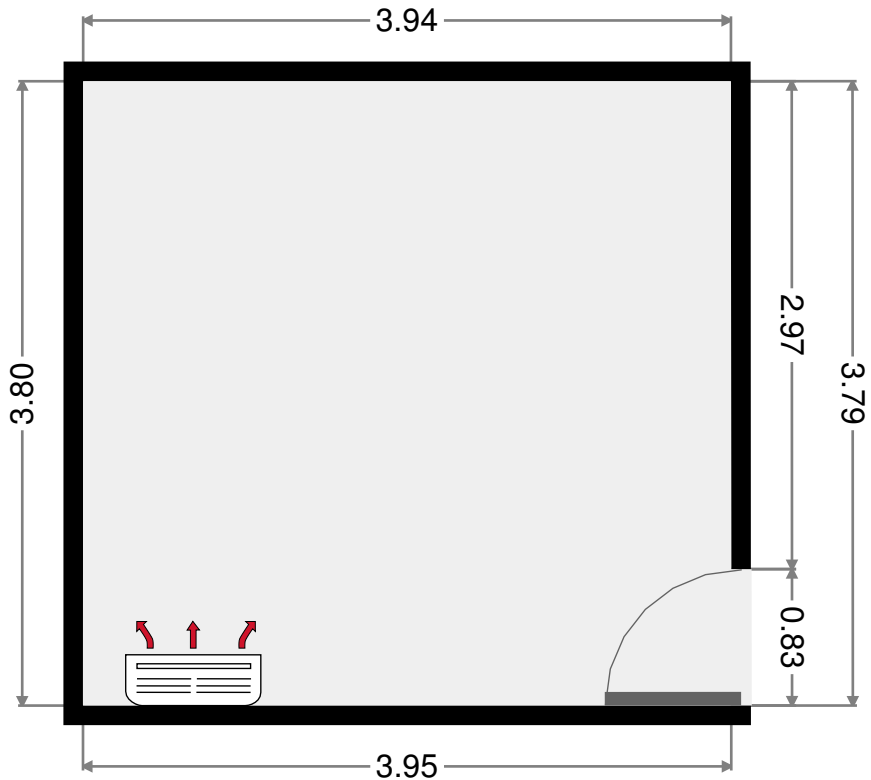
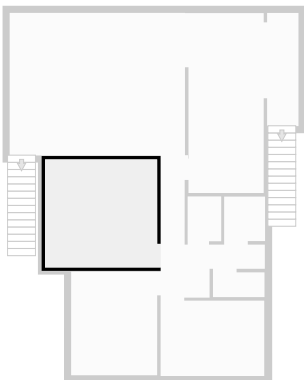

THIS FLOORPLAN IS PROVIDED WITHOUT WARRANTY OF ANY KIND. SENSOPIA DISCLAIMS ANY WARRANTY INCLUDING, WITHOUT LIMITATION, SATISFACTORY QUALITY OR ACCURACY OF DIMENSIONS.