

197 Harrison Street

SUBMITTED BY

Ray White Rockhampton Casey
stockers@cqoz.com

CREATED ON

2022-11-02

Floors

2

▼ Ground Floor

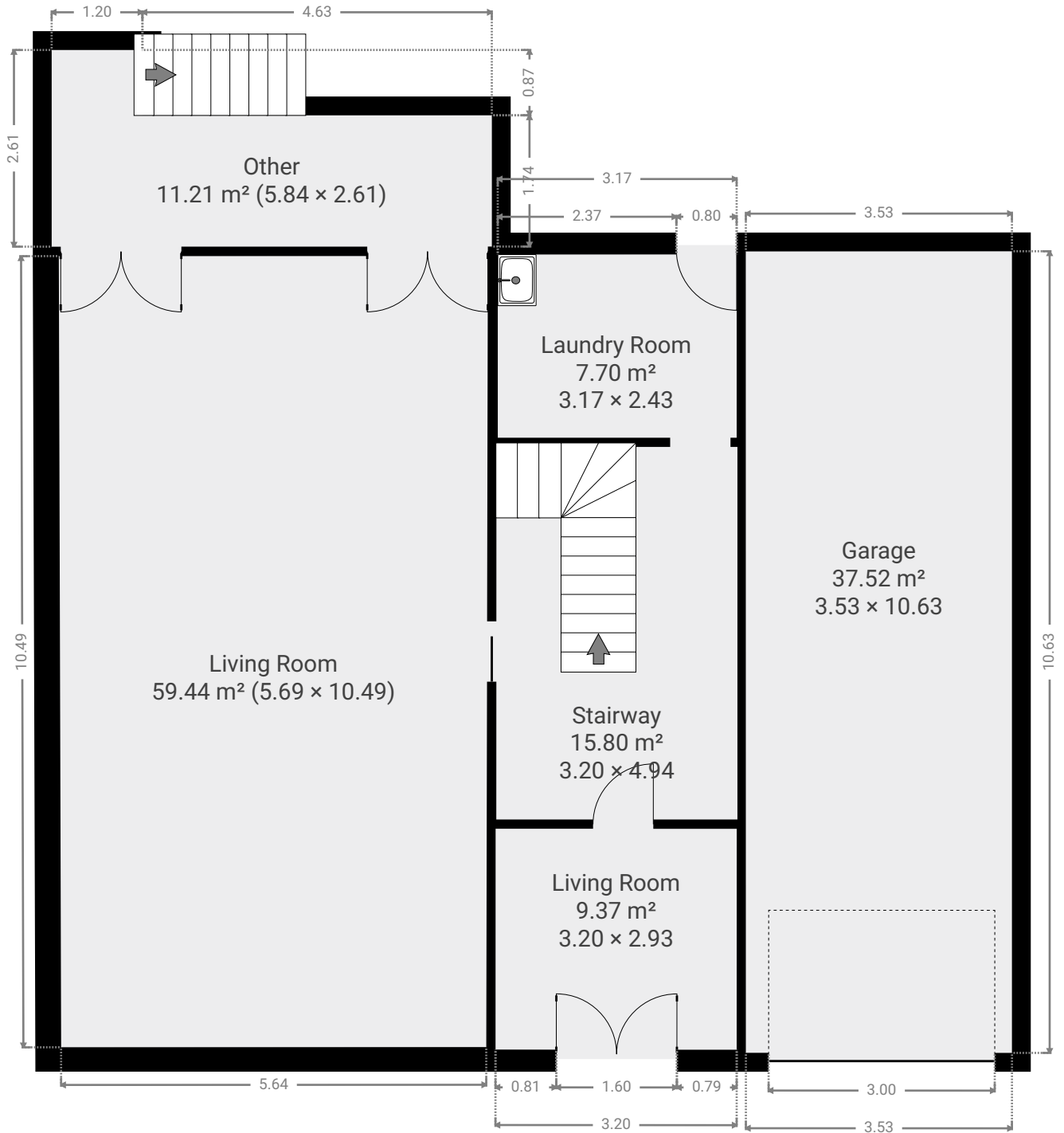

▼ **Garage**
Ground Floor

WIDTH: 3.53 m • LENGTH: 10.63 m
AREA: 37.52 m² • PERIMETER: 28.32 m

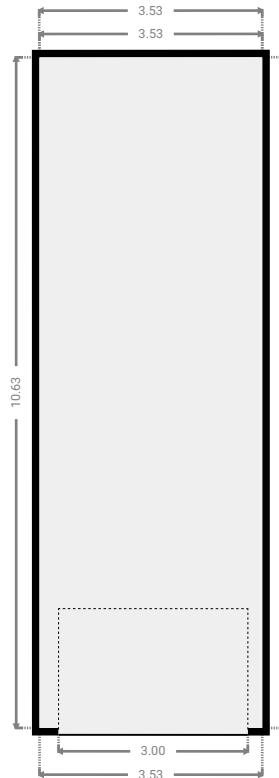
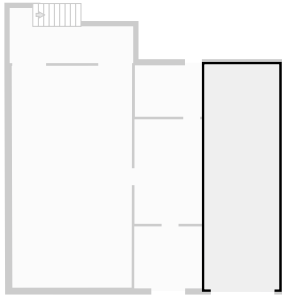

▼ **Laundry Room**
Ground Floor

WIDTH: 3.17 m • LENGTH: 2.43 m
AREA: 7.70 m² • PERIMETER: 11.20 m

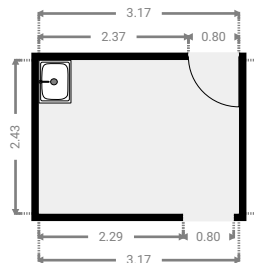
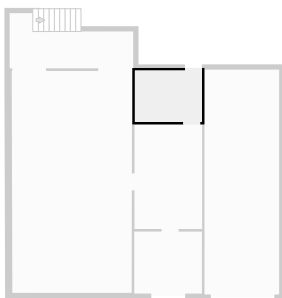

▼ **Living Room**
Ground Floor

WIDTH: 3.20 m • LENGTH: 2.93 m
AREA: 9.37 m² • PERIMETER: 12.26 m

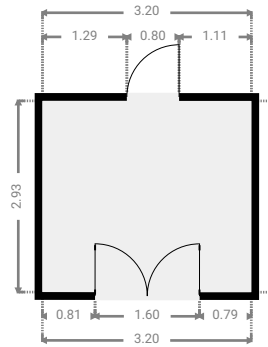
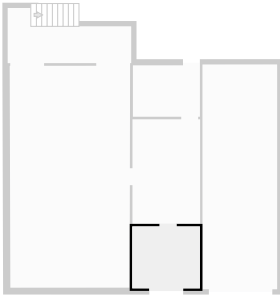

▼ **Living Room**
Ground Floor

WIDTH: 5.69 m • LENGTH: 10.49 m
AREA: 59.44 m² • PERIMETER: 32.31 m

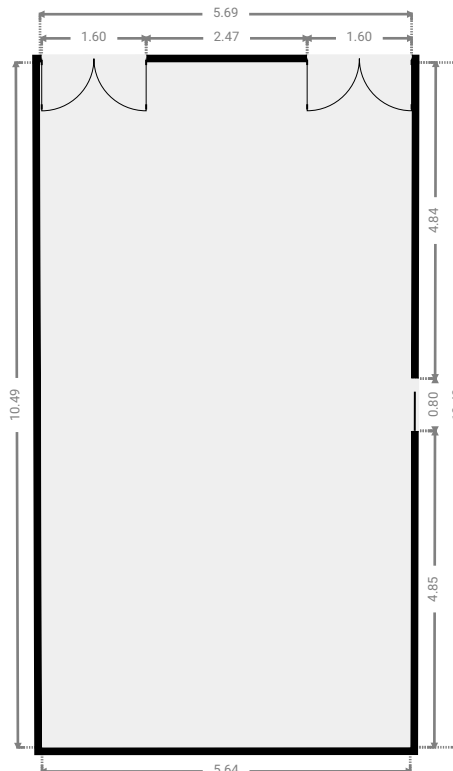
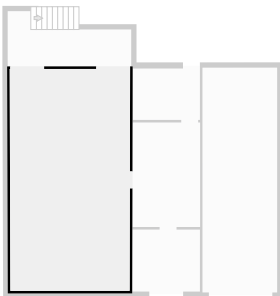

▼ **Other**
Ground Floor

WIDTH: 5.84 m • LENGTH: 2.61 m
AREA: 11.21 m² • PERIMETER: 16.89 m

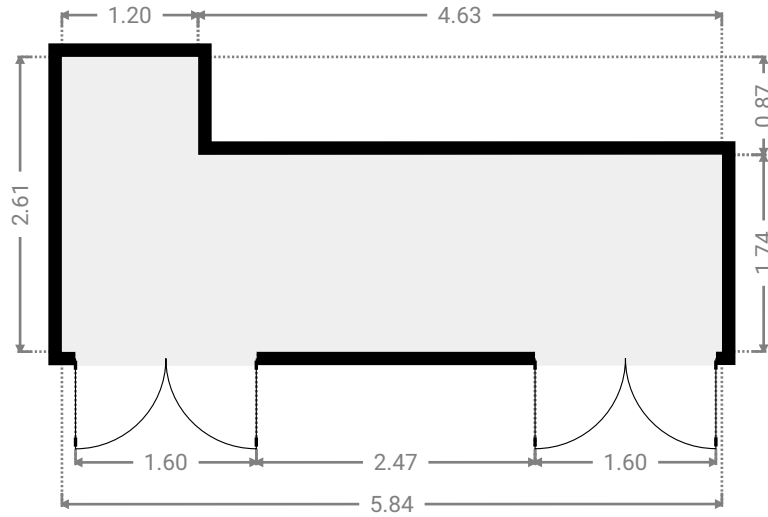
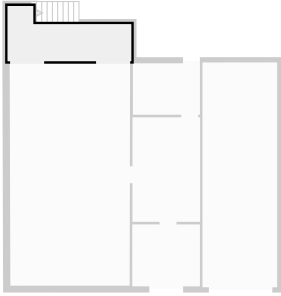

▼ **Stairway**
Ground Floor

WIDTH: 3.20 m • LENGTH: 4.94 m
AREA: 15.80 m² • PERIMETER: 16.28 m

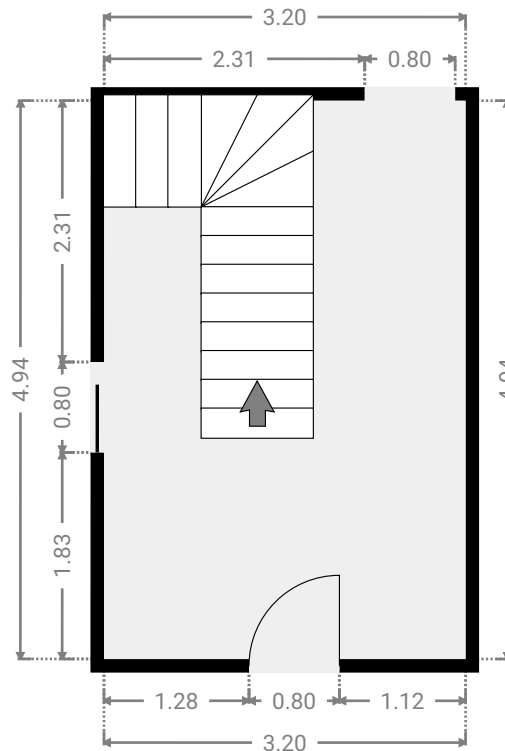
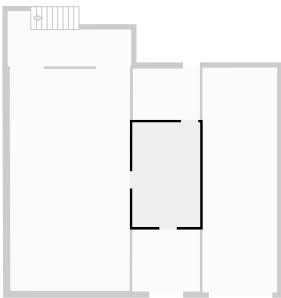

▼ 1st Floor

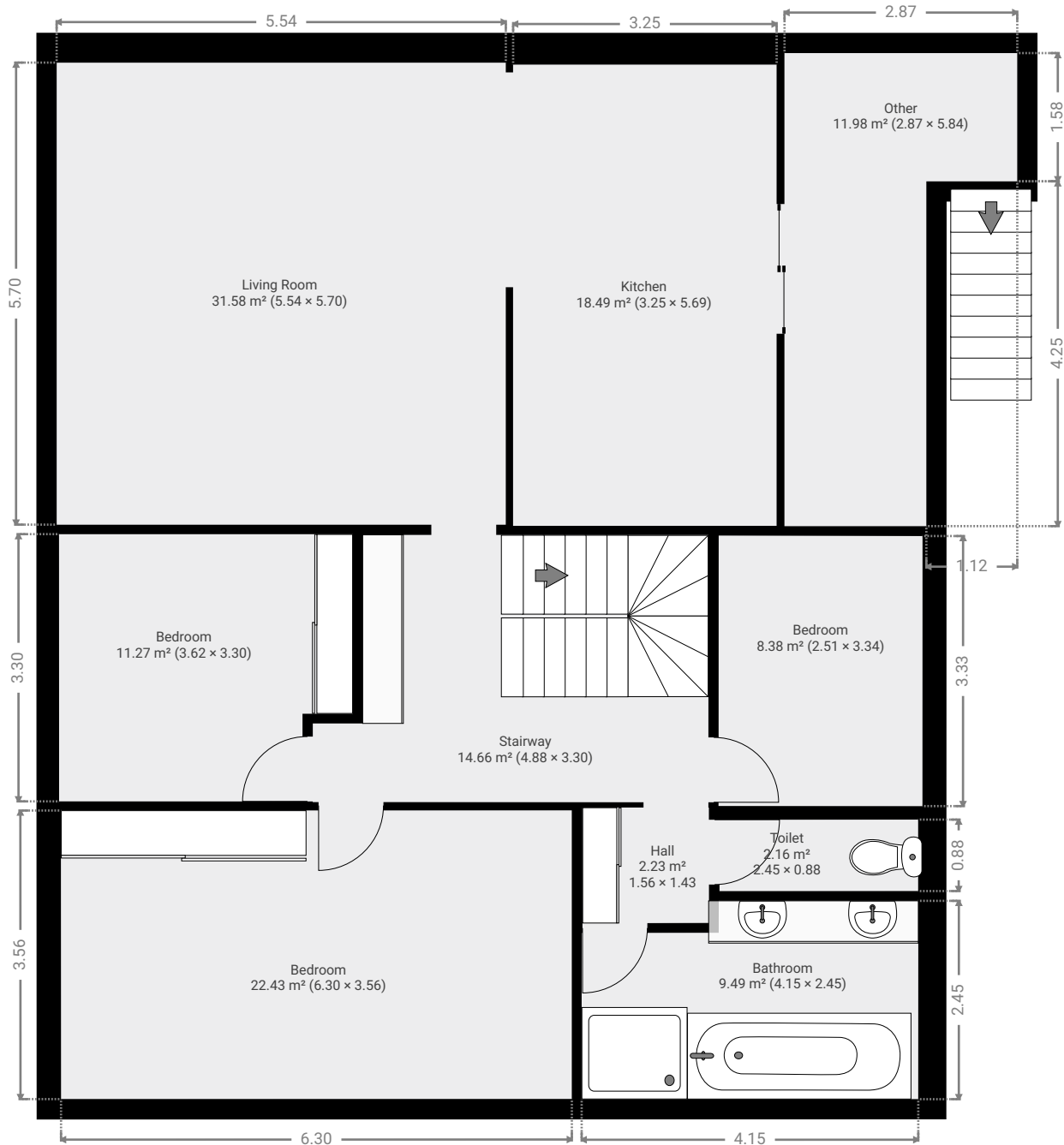

▼ **Bathroom**
1st Floor

WIDTH: 2.45 m • LENGTH: 4.15 m
AREA: 9.49 m² • PERIMETER: 13.20 m

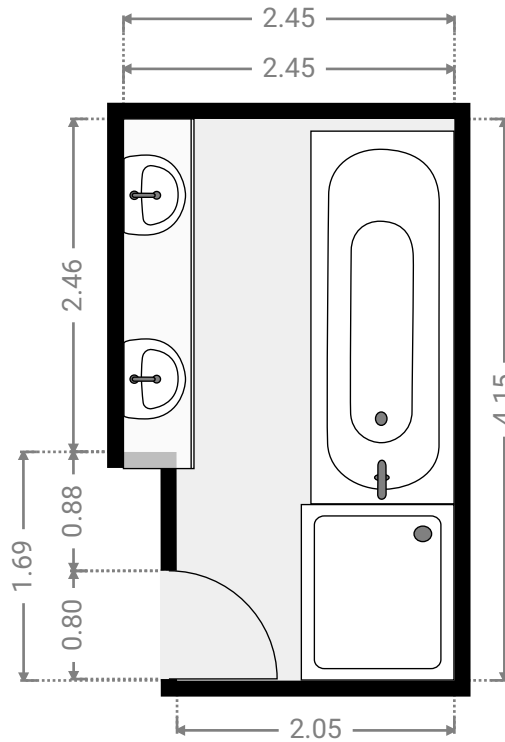
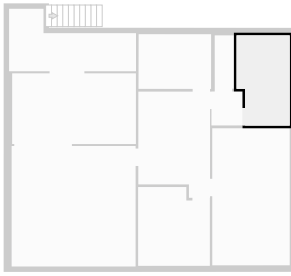

▼ **Bedroom**
1st Floor

WIDTH: 3.34 m • LENGTH: 2.51 m
AREA: 8.38 m² • PERIMETER: 11.70 m

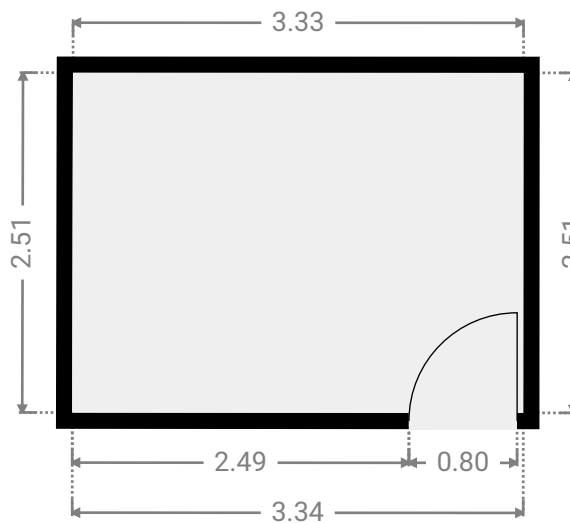
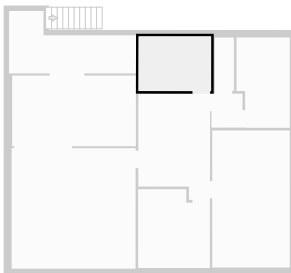

▼ **Bedroom**
1st Floor

WIDTH: 3.30 m • LENGTH: 3.62 m
AREA: 11.27 m² • PERIMETER: 13.84 m

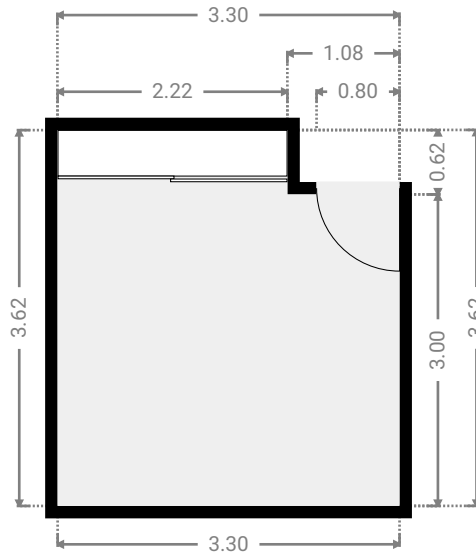
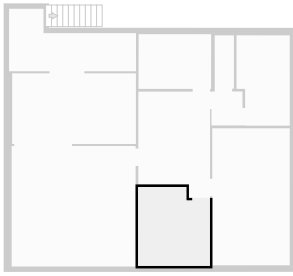

▼ **Bedroom**
1st Floor

WIDTH: 3.56 m • LENGTH: 6.30 m
AREA: 22.43 m² • PERIMETER: 19.72 m

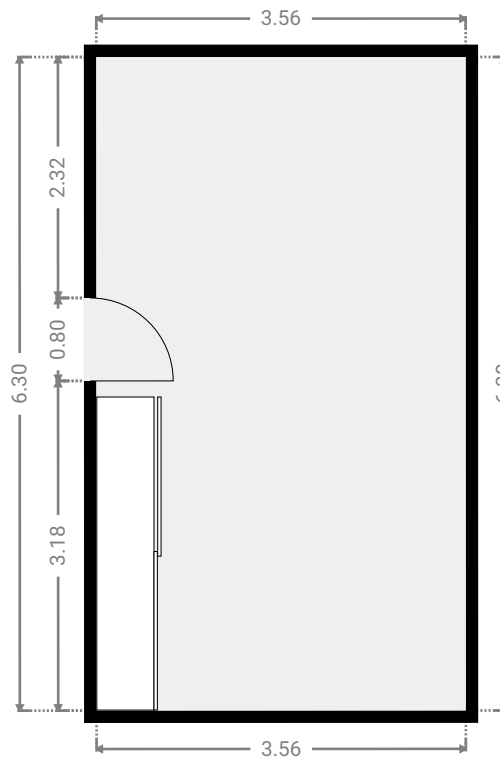
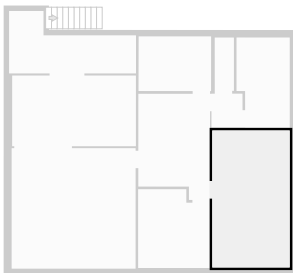

▼ **Hall**
1st Floor

WIDTH: 1.43 m • LENGTH: 1.56 m
AREA: 2.23 m² • PERIMETER: 5.97 m

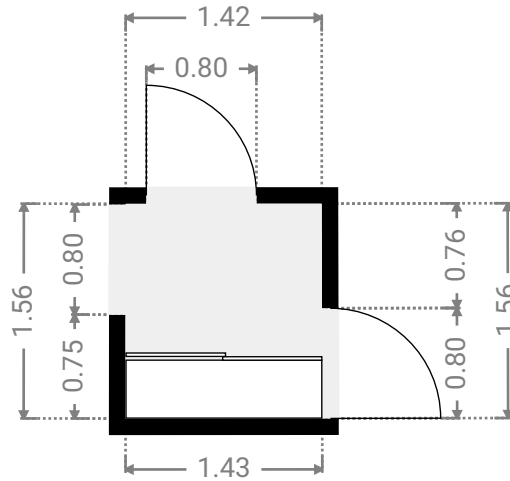
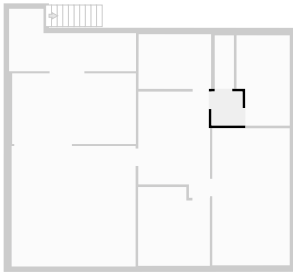

▼ **Kitchen**
1st Floor

WIDTH: 5.69 m • LENGTH: 3.25 m
AREA: 18.49 m² • PERIMETER: 17.88 m

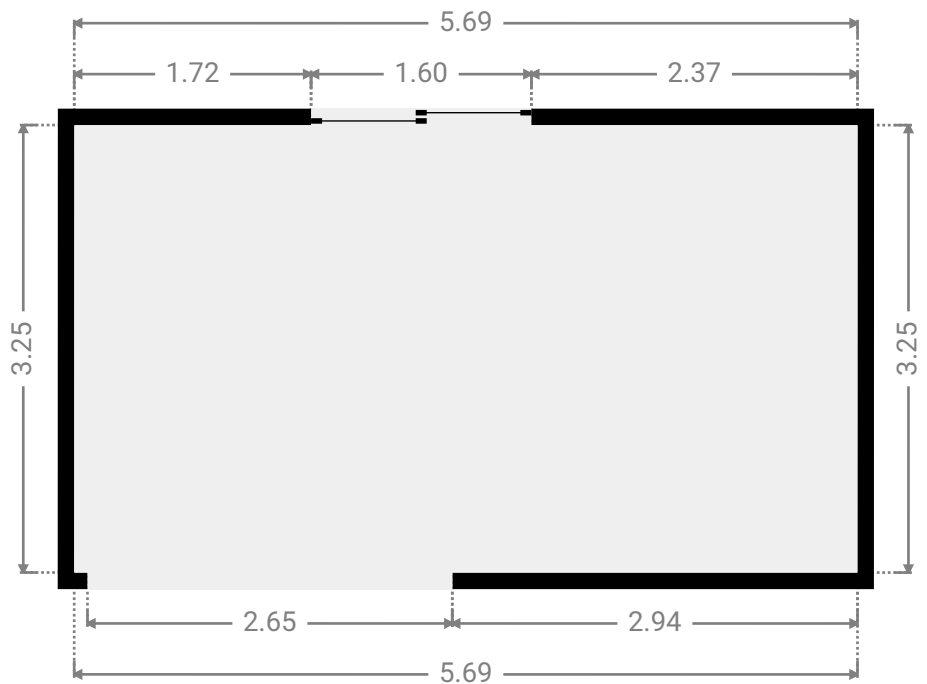
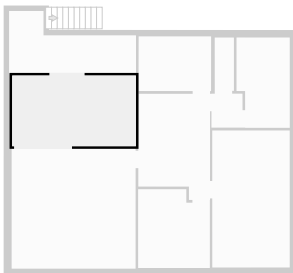

▼ Living Room
1st Floor

WIDTH: 5.70 m • LENGTH: 5.54 m
AREA: 31.58 m² • PERIMETER: 22.48 m

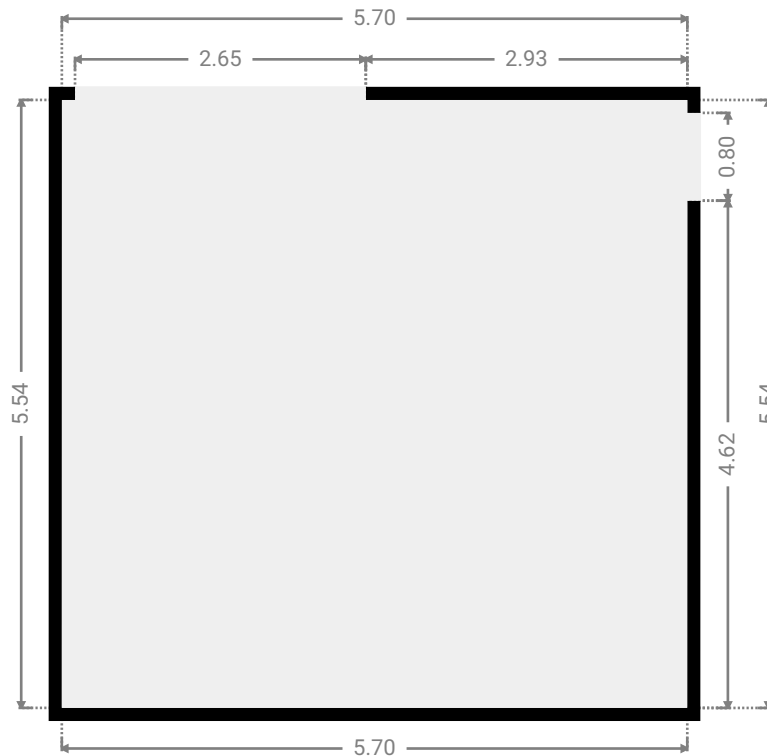
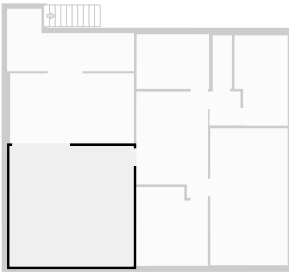

▼ Other
1st Floor

WIDTH: 5.84 m • LENGTH: 2.87 m
AREA: 11.98 m² • PERIMETER: 17.41 m

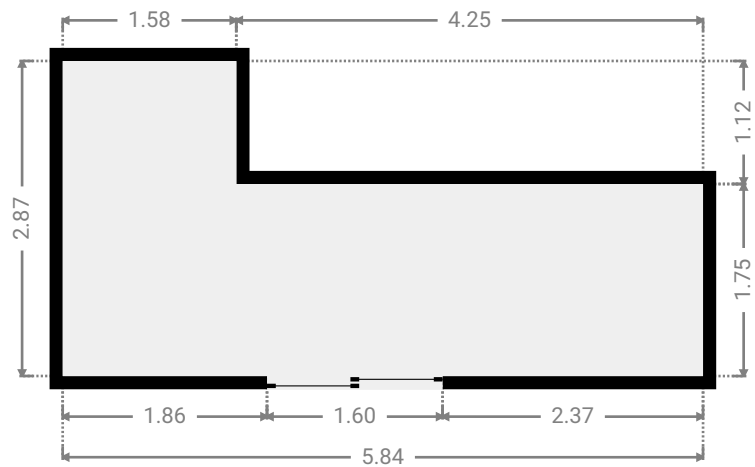
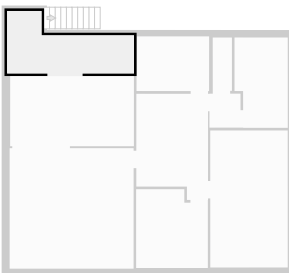

▼ **Stairway**
1st Floor

WIDTH: 3.30 m • LENGTH: 4.88 m
AREA: 14.66 m² • PERIMETER: 16.35 m

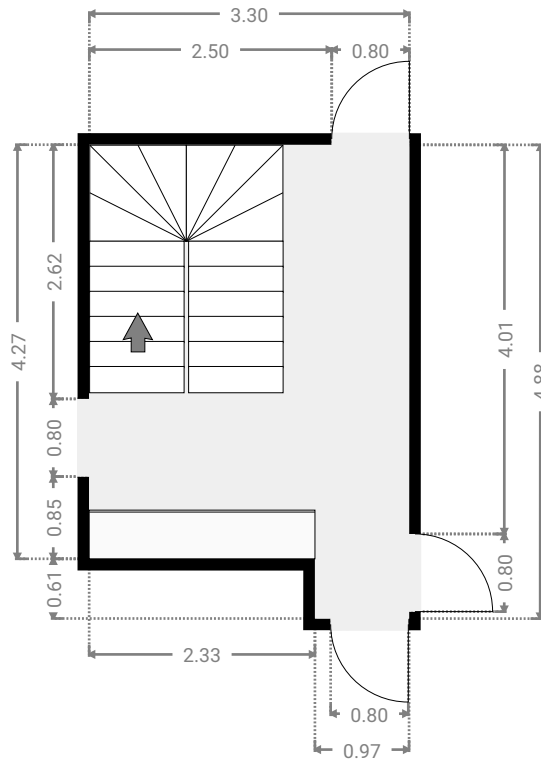
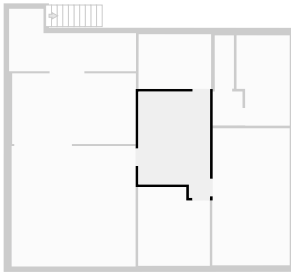

▼ **Toilet**
1st Floor

WIDTH: 0.88 m • LENGTH: 2.45 m
AREA: 2.16 m² • PERIMETER: 6.66 m

