

19 Ridgedale Avenue

Ground Floor

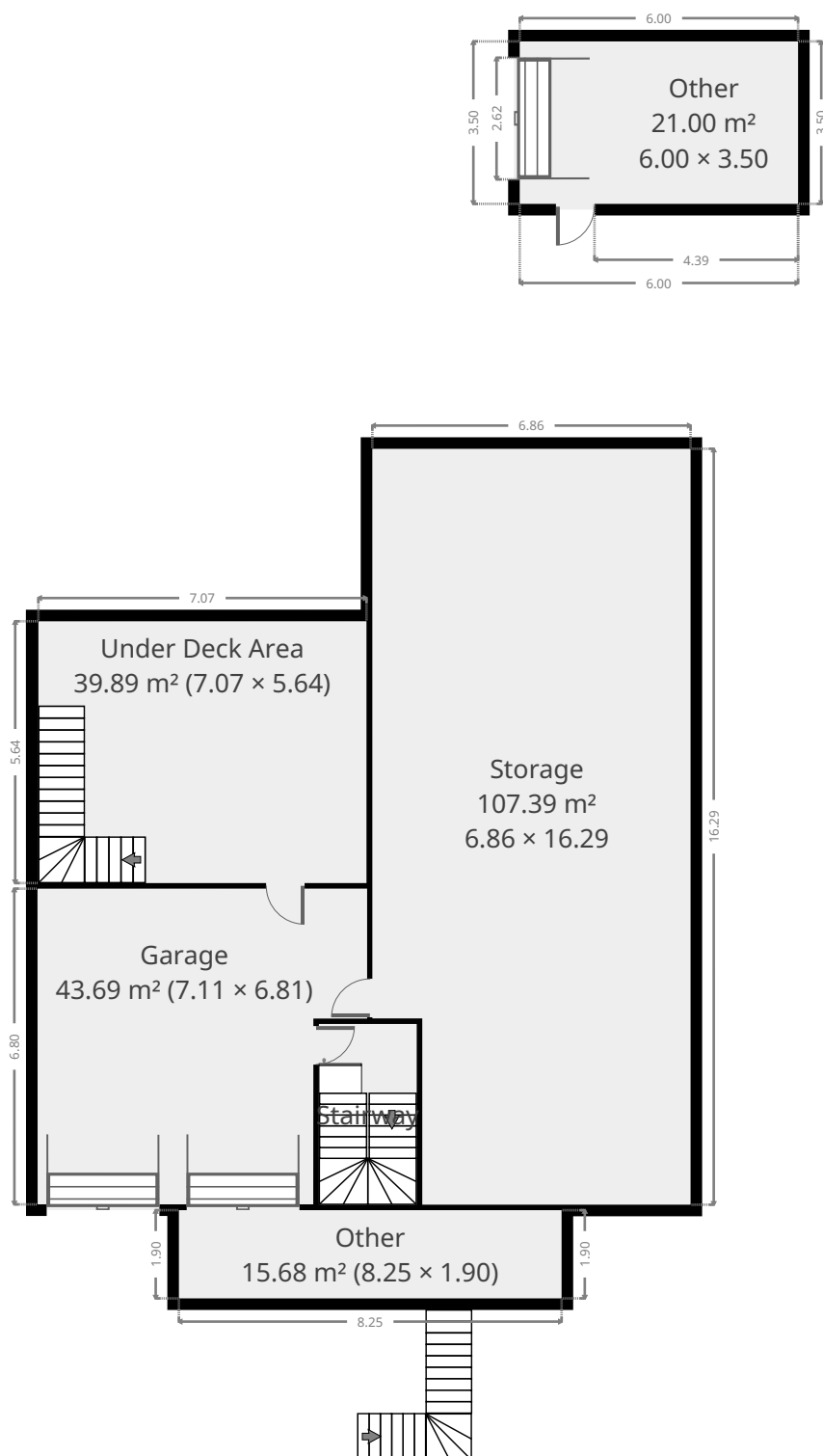

THIS FLOORPLAN IS PROVIDED WITHOUT WARRANTY OF ANY KIND. SENSOPIA DISCLAIMS ANY WARRANTY INCLUDING, WITHOUT LIMITATION, SATISFACTORY QUALITY OR ACCURACY OF DIMENSIONS.



19 Ridgedale Avenue

Stairway

Width: 2.11 m
 Length: 3.90 m
 Area: 8.22 m²
 Perimeter: 12.01 m

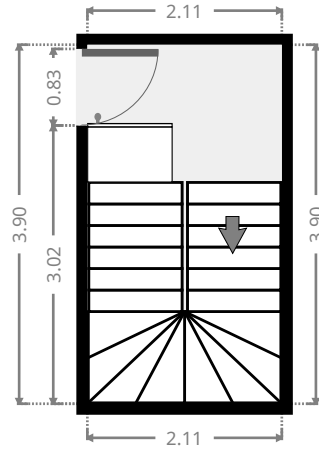
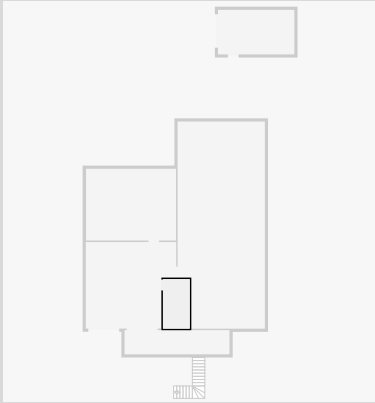

Garage

Width: 6.81 m
 Length: 7.11 m
 Area: 43.69 m²
 Perimeter: 27.81 m

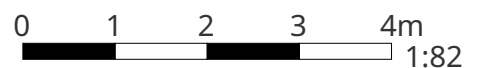
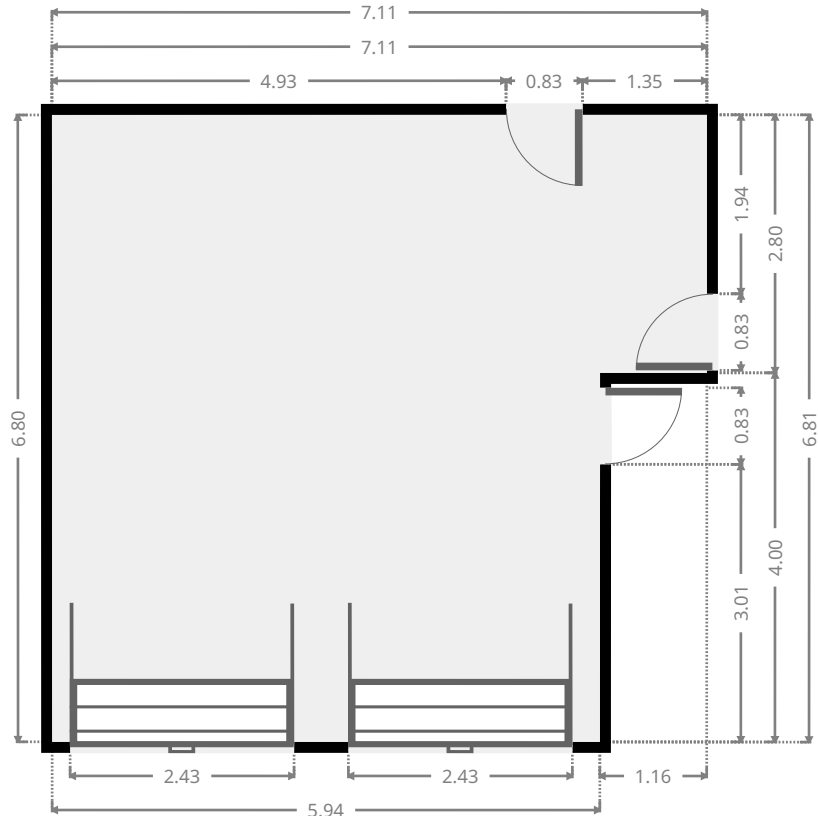
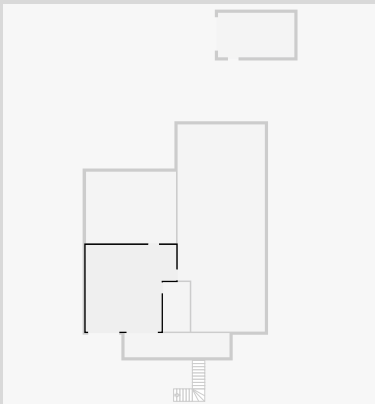

THIS FLOORPLAN IS PROVIDED WITHOUT WARRANTY OF ANY KIND. SENSOPIA DISCLAIMS ANY WARRANTY INCLUDING, WITHOUT LIMITATION, SATISFACTORY QUALITY OR ACCURACY OF DIMENSIONS.

19 Ridgedale Avenue

Storage

Width: 6.86 m
Length: 16.29 m
Area: 107.39 m²
Perimeter: 46.29 m

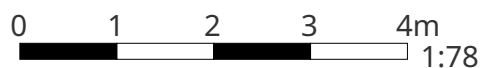
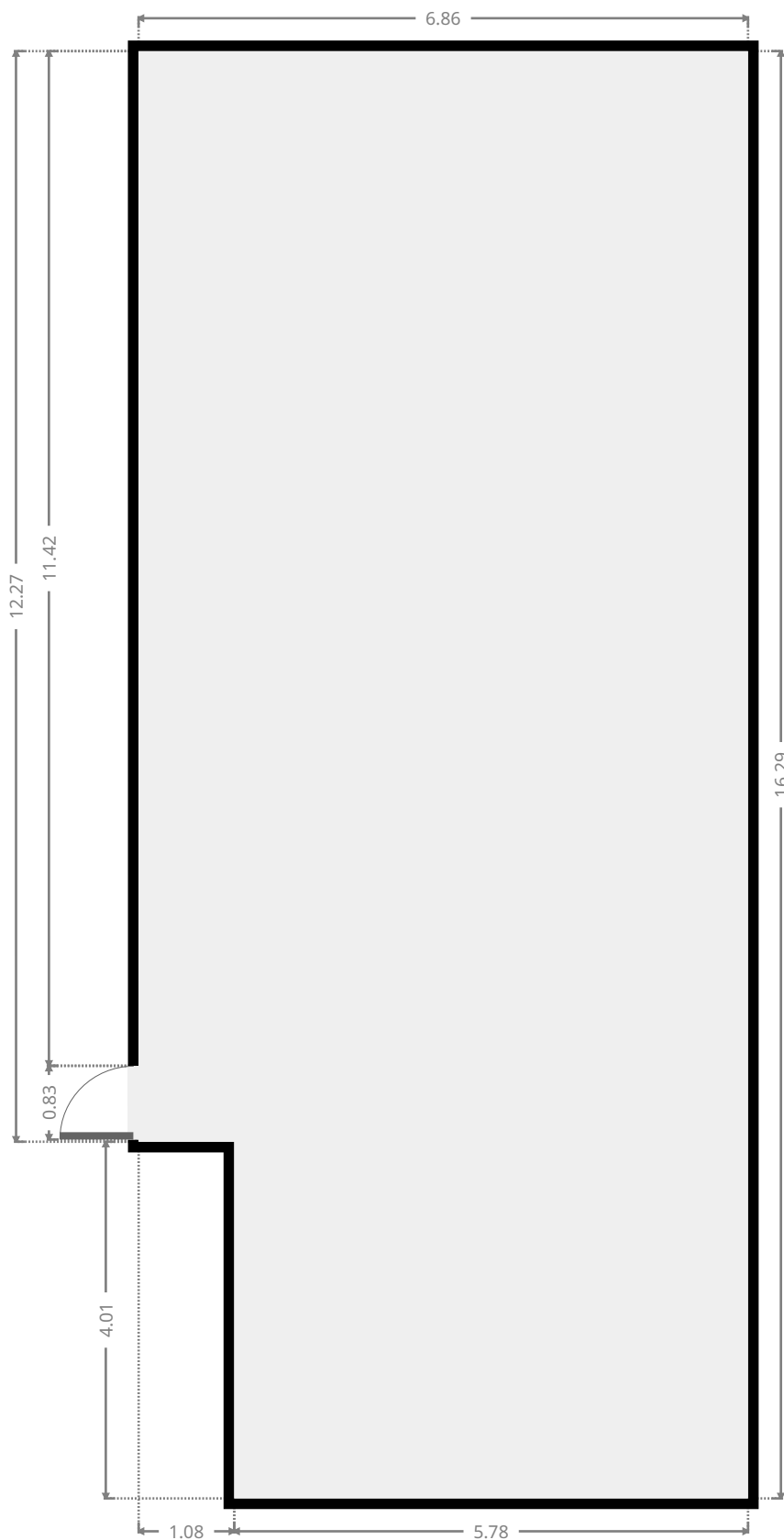
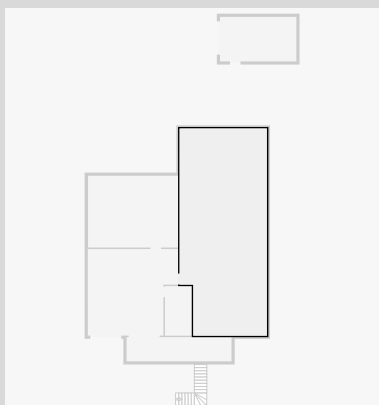

THIS FLOORPLAN IS PROVIDED WITHOUT WARRANTY OF ANY KIND. SENSOPIA DISCLAIMS ANY WARRANTY INCLUDING, WITHOUT LIMITATION, SATISFACTORY QUALITY OR ACCURACY OF DIMENSIONS.

19 Ridgedale Avenue

Under Deck Area

Width: 5.64 m
 Length: 7.07 m
 Area: 39.89 m²
 Perimeter: 25.43 m

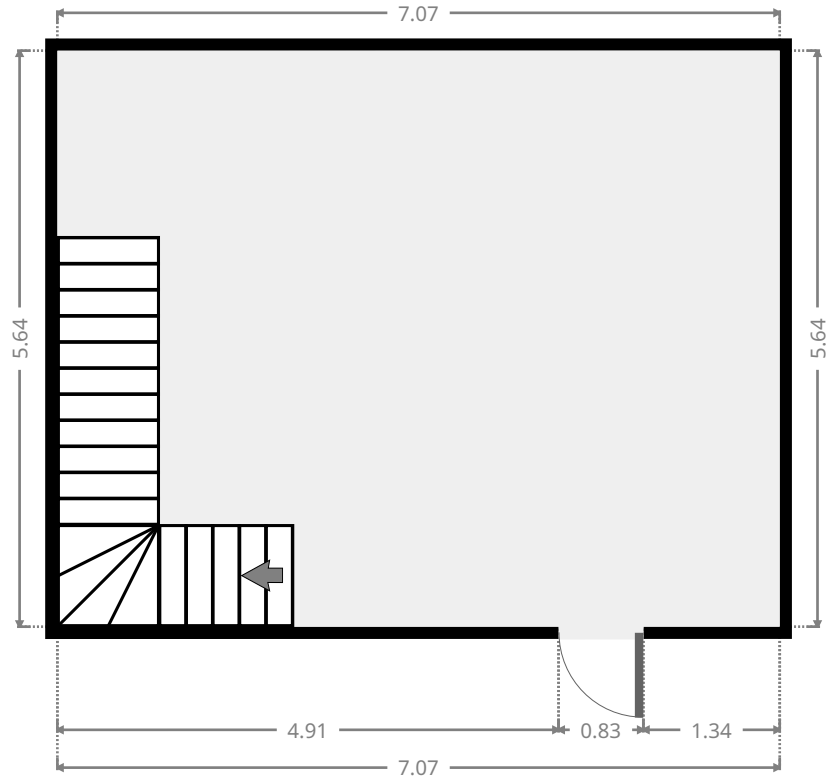
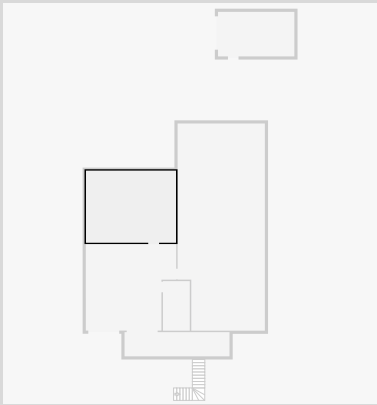

Other

Width: 1.90 m
 Length: 8.25 m
 Area: 15.68 m²
 Perimeter: 20.30 m

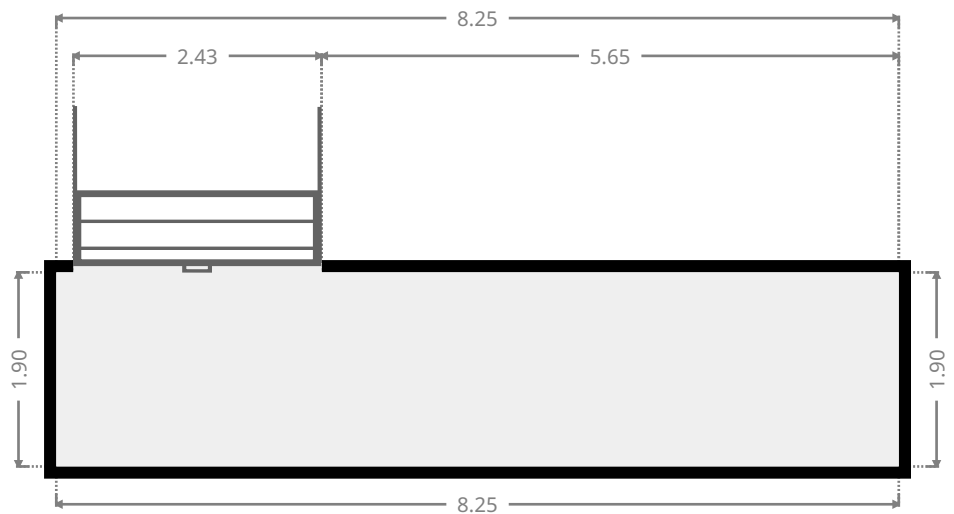
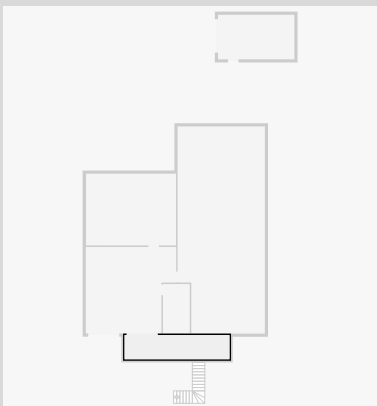

19 Ridgedale Avenue

Other

Width: 3.50 m
Length: 6.00 m
Area: 21.00 m²
Perimeter: 19.00 m

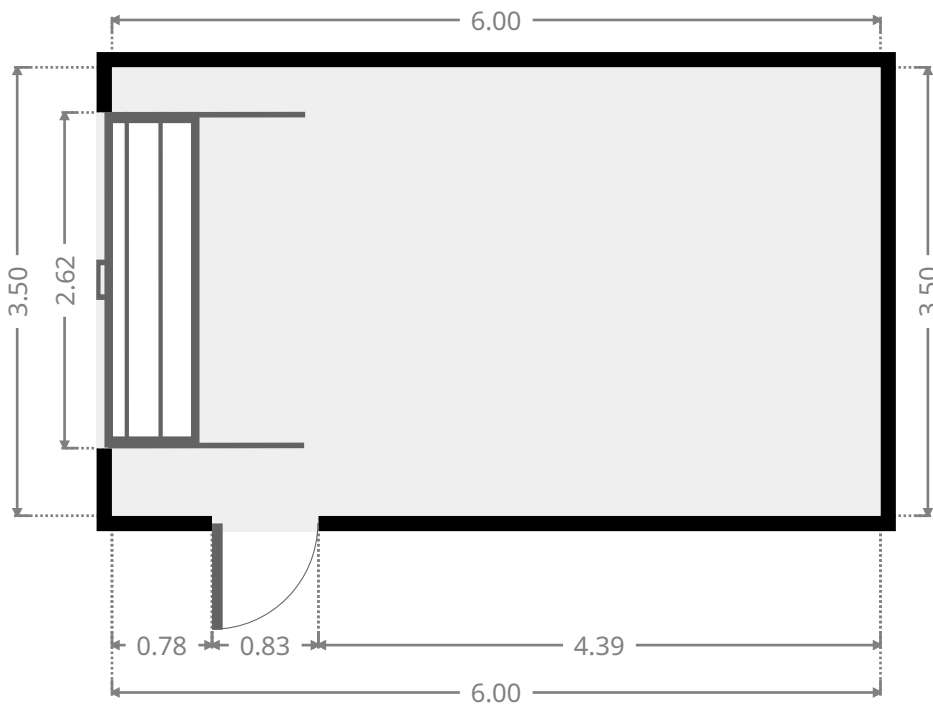
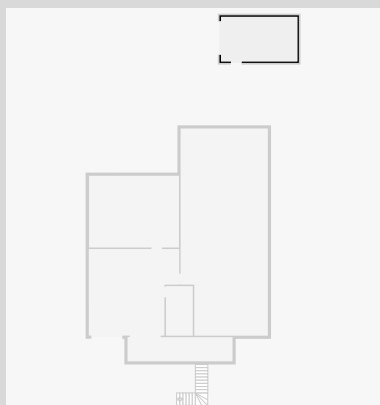

19 Ridgedale Avenue

1st Floor

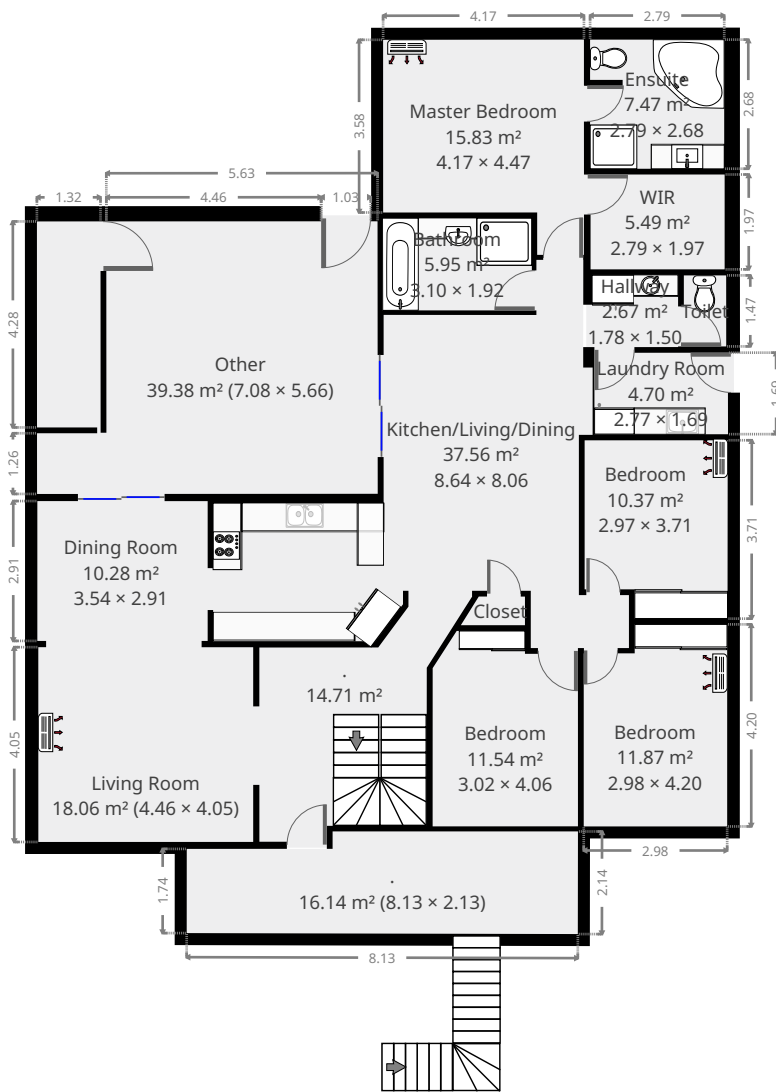

THIS FLOORPLAN IS PROVIDED WITHOUT WARRANTY OF ANY KIND. SENSOPIA DISCLAIMS ANY WARRANTY INCLUDING, WITHOUT LIMITATION, SATISFACTORY QUALITY OR ACCURACY OF DIMENSIONS.



19 Ridgedale Avenue

Master Bedroom

Width: 4.17 m
 Length: 4.47 m
 Area: 15.83 m²
 Perimeter: 17.28 m

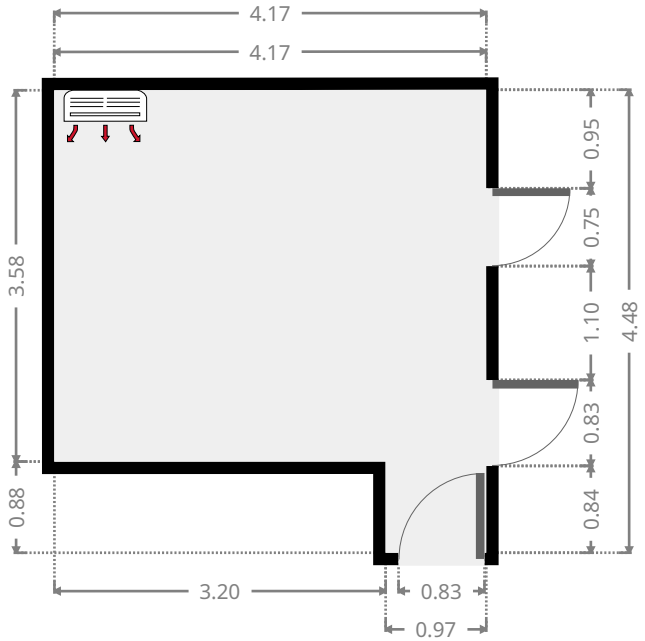
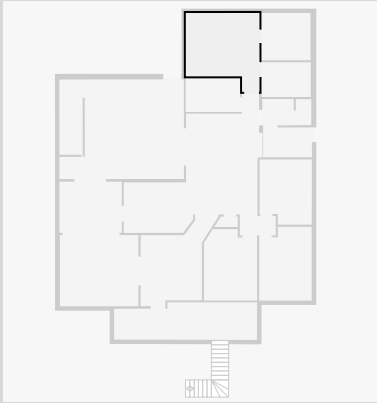

Width: 2.13 m
 Length: 8.13 m
 Area: 16.14 m²
 Perimeter: 20.50 m

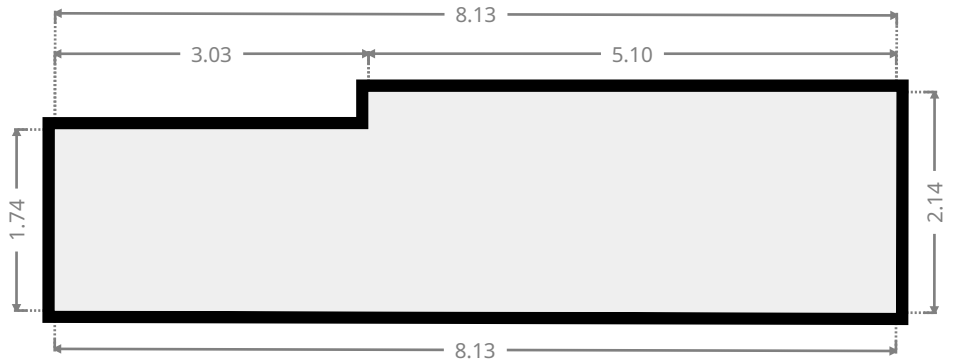
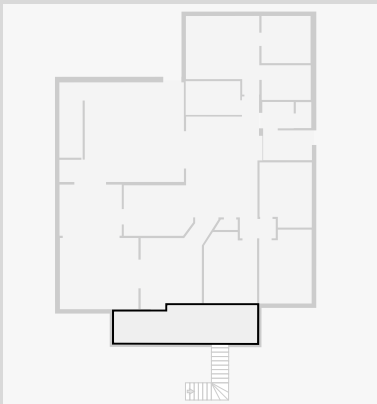

THIS FLOORPLAN IS PROVIDED WITHOUT WARRANTY OF ANY KIND. SENSOPIA DISCLAIMS ANY WARRANTY INCLUDING, WITHOUT LIMITATION, SATISFACTORY QUALITY OR ACCURACY OF DIMENSIONS.



19 Ridgedale Avenue

Other

Width: 5.66 m
 Length: 7.08 m
 Area: 39.38 m²
 Perimeter: 36.76 m

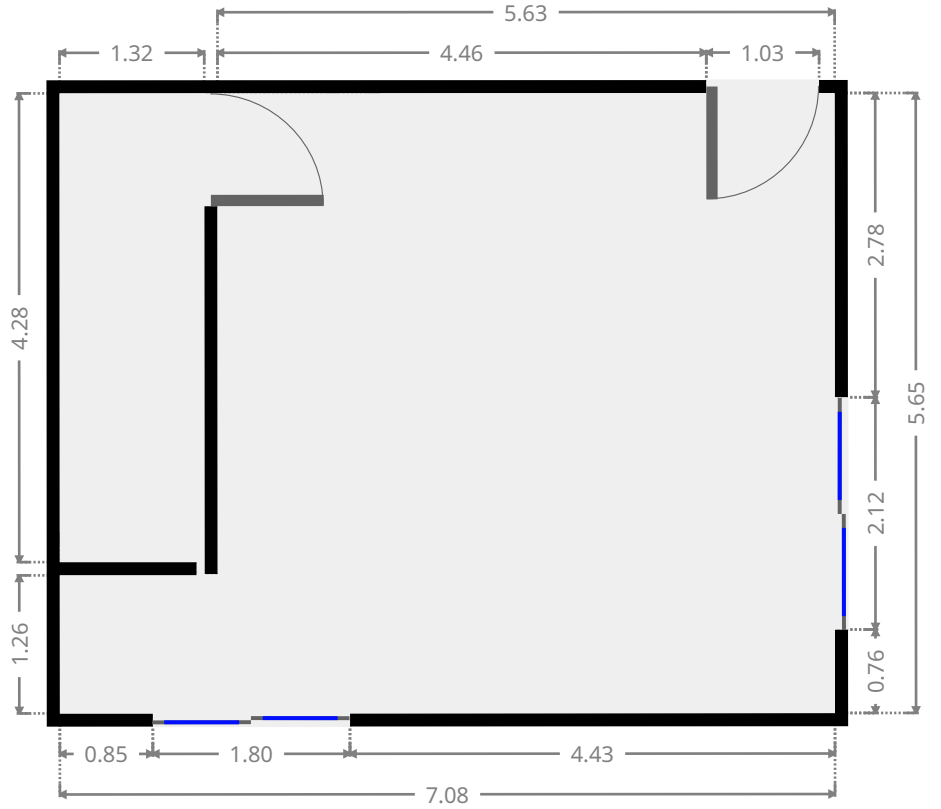
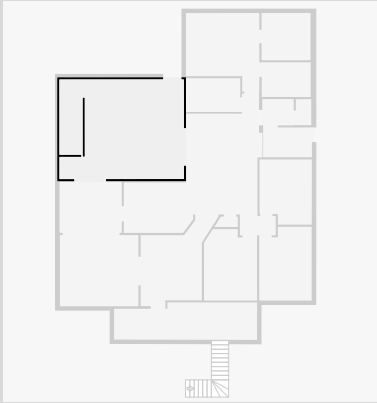

Bedroom

Width: 2.97 m
 Length: 3.71 m
 Area: 10.37 m²
 Perimeter: 13.35 m

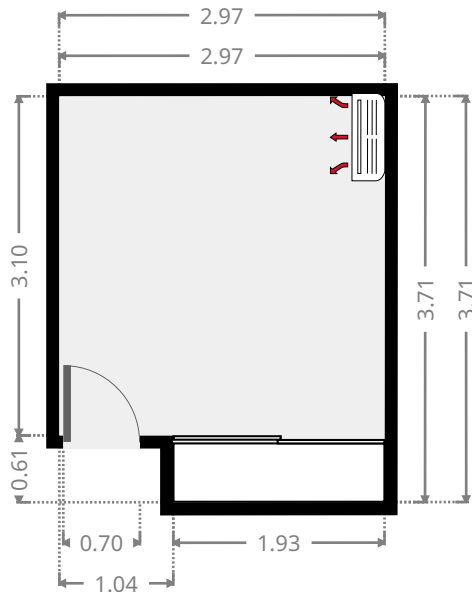
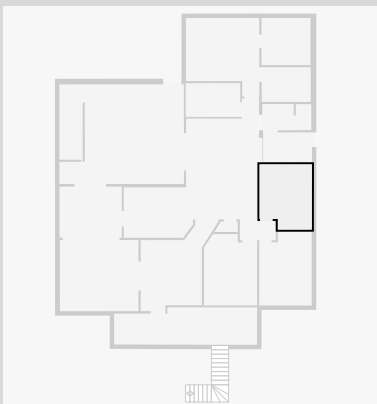

THIS FLOORPLAN IS PROVIDED WITHOUT WARRANTY OF ANY KIND. SENSOPIA DISCLAIMS ANY WARRANTY INCLUDING, WITHOUT LIMITATION, SATISFACTORY QUALITY OR ACCURACY OF DIMENSIONS.

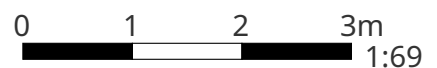

19 Ridgedale Avenue

Bedroom

Width: 2.98 m
 Length: 4.20 m
 Area: 11.87 m²
 Perimeter: 14.35 m

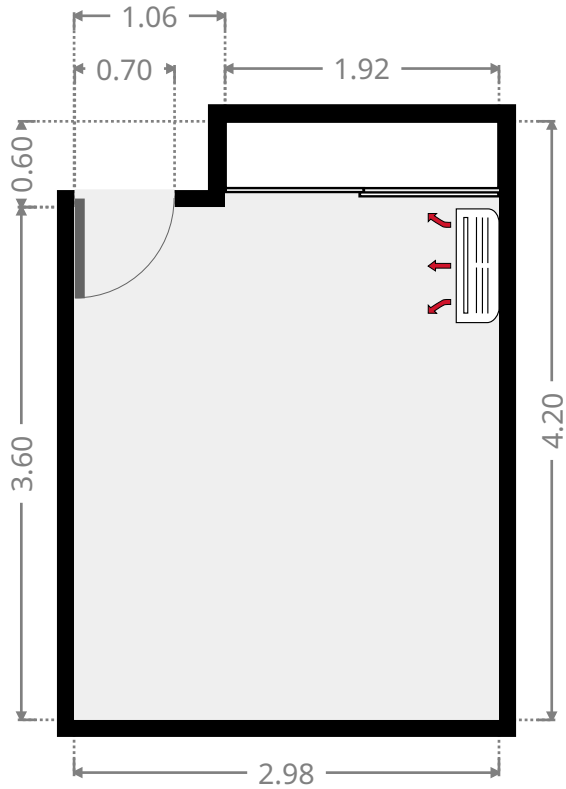
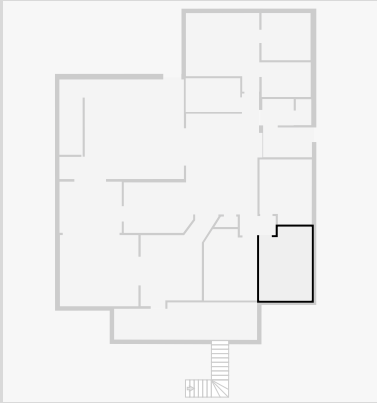

Closet

Width: 0.59 m
 Length: 1.33 m
 Area: 0.68 m²
 Perimeter: 3.59 m

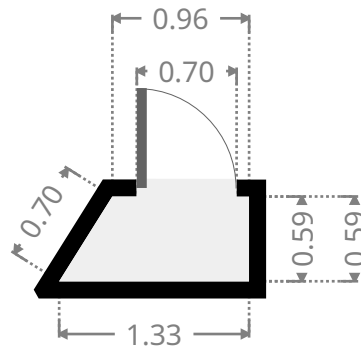
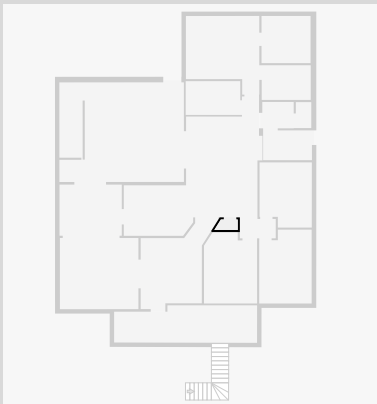

19 Ridgedale Avenue

Bedroom

Width: 3.02 m
 Length: 4.06 m
 Area: 11.54 m²
 Perimeter: 13.80 m

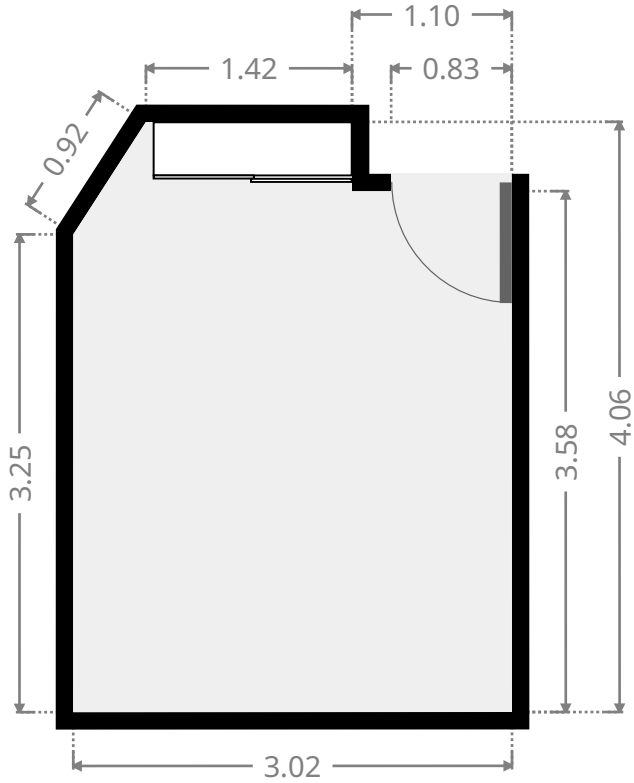
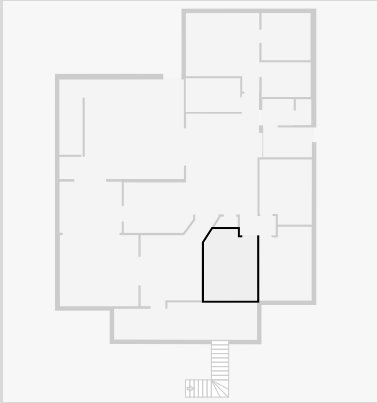

Ensuite

Width: 2.68 m
 Length: 2.79 m
 Area: 7.47 m²
 Perimeter: 10.94 m

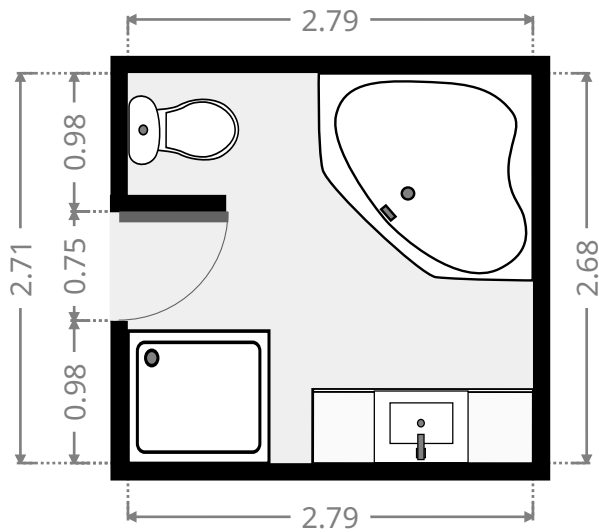
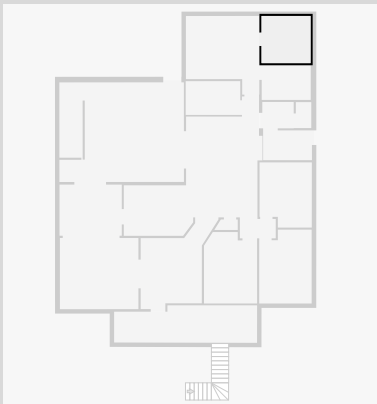

THIS FLOORPLAN IS PROVIDED WITHOUT WARRANTY OF ANY KIND. SENSOPIA DISCLAIMS ANY WARRANTY INCLUDING, WITHOUT LIMITATION, SATISFACTORY QUALITY OR ACCURACY OF DIMENSIONS.

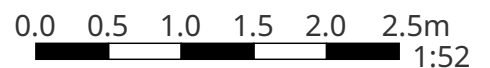

19 Ridgedale Avenue

WIR

Width: 1.97 m
 Length: 2.79 m
 Area: 5.49 m²
 Perimeter: 9.51 m

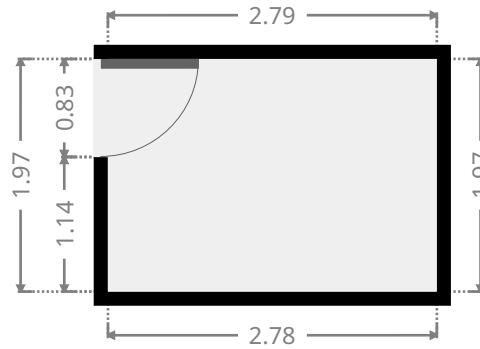
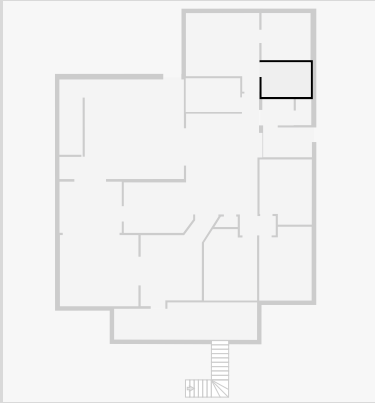

Width: 4.42 m
 Length: 5.09 m
 Area: 14.71 m²
 Perimeter: 17.93 m

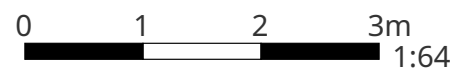
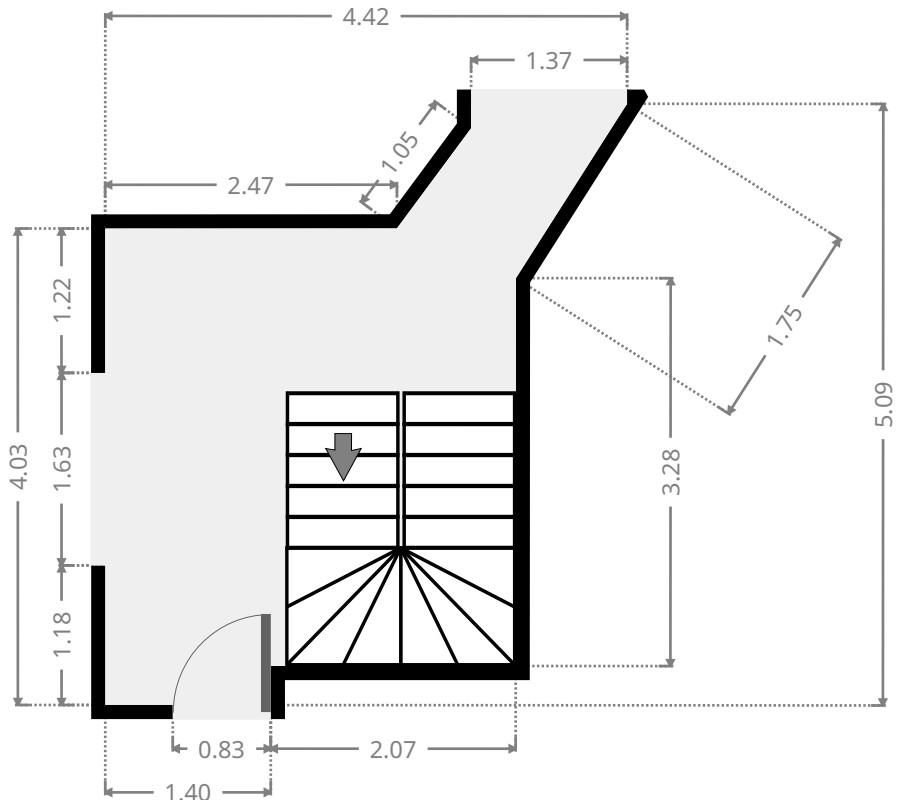
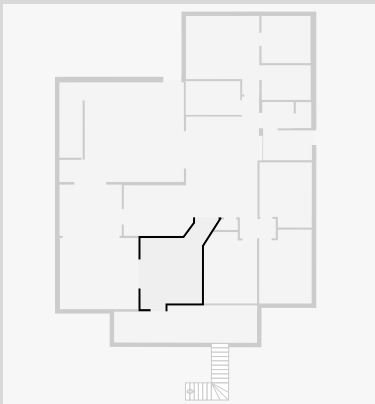

THIS FLOORPLAN IS PROVIDED WITHOUT WARRANTY OF ANY KIND. SENSOPIA DISCLAIMS ANY WARRANTY INCLUDING, WITHOUT LIMITATION, SATISFACTORY QUALITY OR ACCURACY OF DIMENSIONS.

19 Ridgedale Avenue

Toilet / Half Bath

Width: 0.88 m
 Length: 1.48 m
 Area: 1.30 m²
 Perimeter: 4.71 m

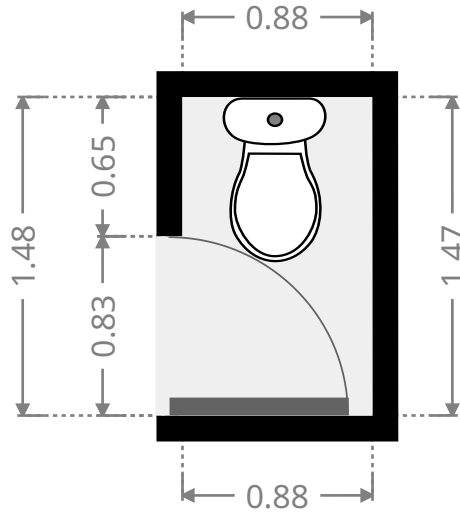
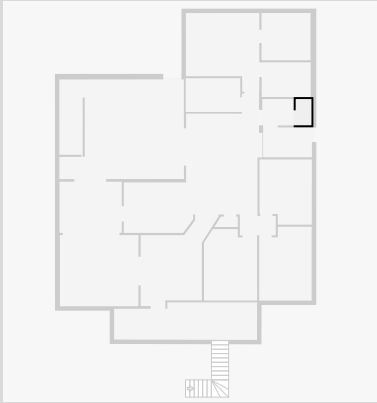

Laundry Room

Width: 1.69 m
 Length: 2.77 m
 Area: 4.70 m²
 Perimeter: 8.93 m

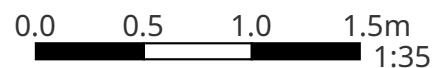
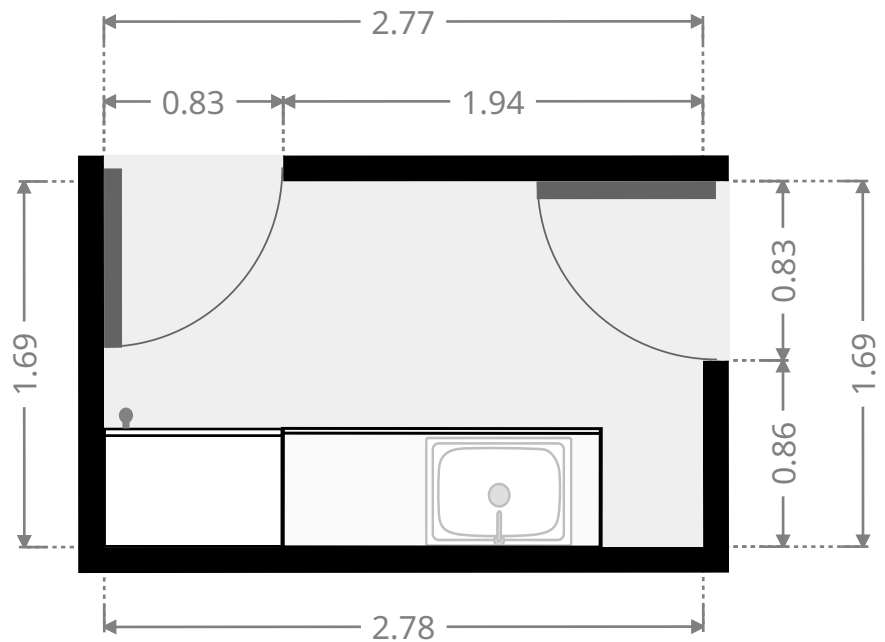
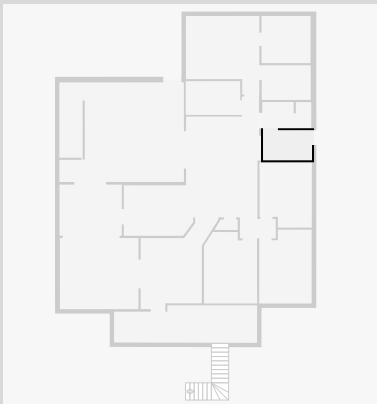

THIS FLOORPLAN IS PROVIDED WITHOUT WARRANTY OF ANY KIND. SENSOPIA DISCLAIMS ANY WARRANTY INCLUDING, WITHOUT LIMITATION, SATISFACTORY QUALITY OR ACCURACY OF DIMENSIONS.

19 Ridgedale Avenue

Hallway

Width: 1.50 m
 Length: 1.78 m
 Area: 2.67 m²
 Perimeter: 6.56 m

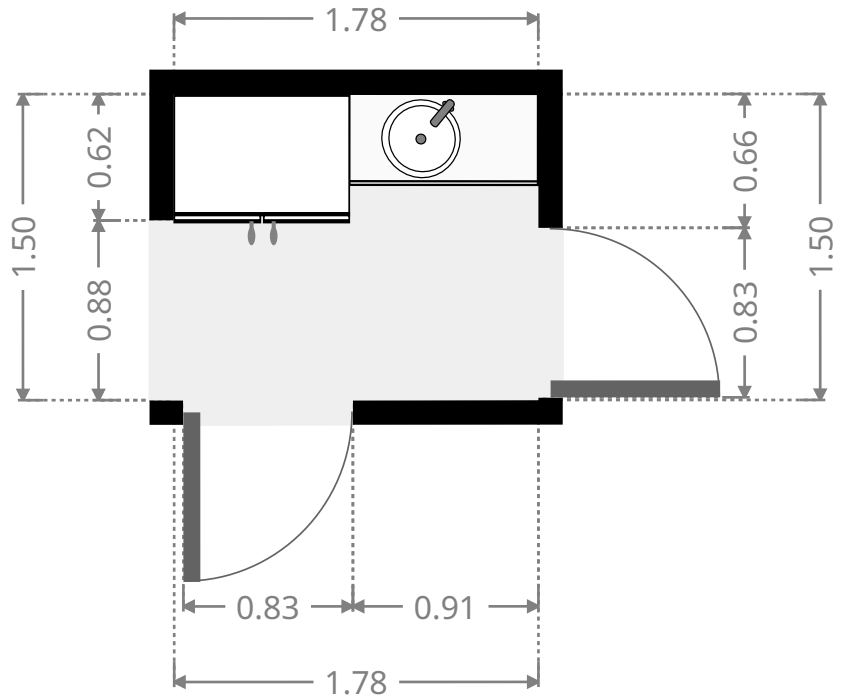
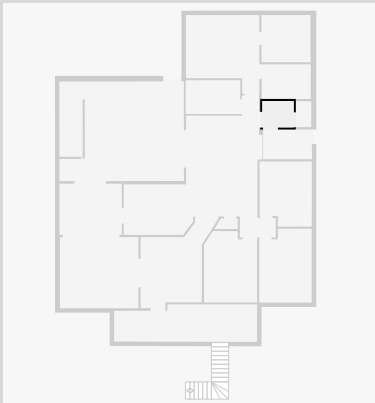

Bathroom

Width: 1.92 m
 Length: 3.10 m
 Area: 5.95 m²
 Perimeter: 10.04 m

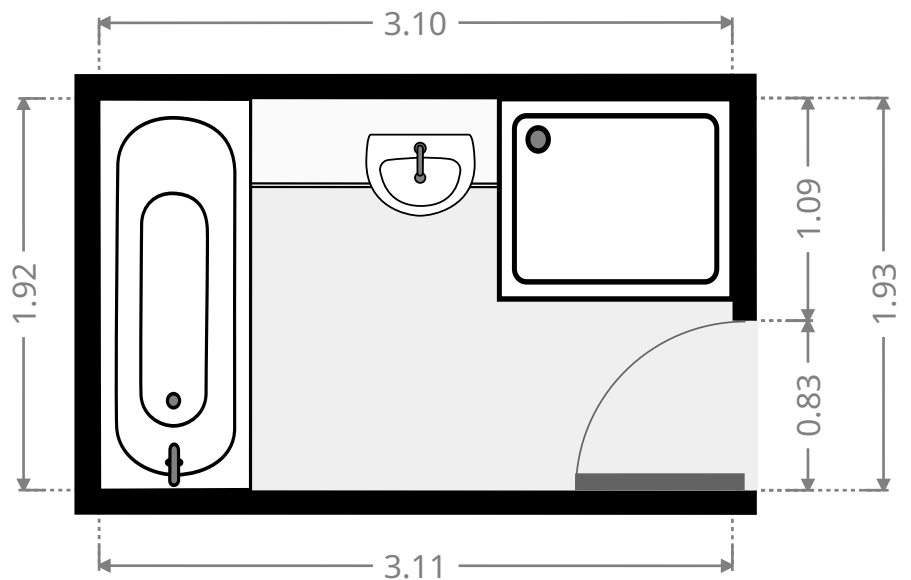
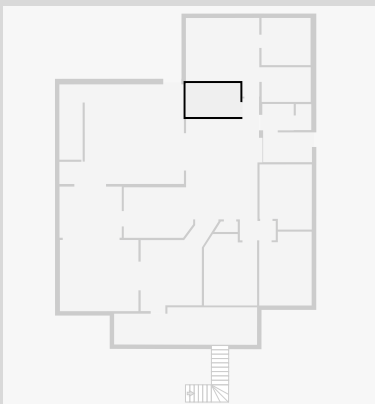

19 Ridgedale Avenue

Kitchen/Living/Dining

Width: 8.06 m
 Length: 8.64 m
 Area: 37.56 m²
 Perimeter: 35.70 m

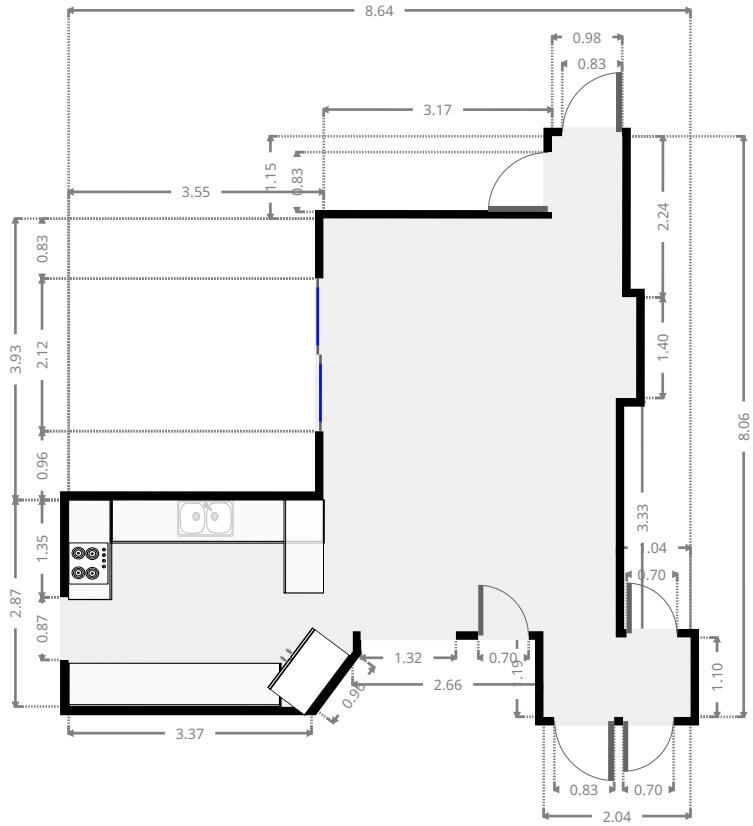
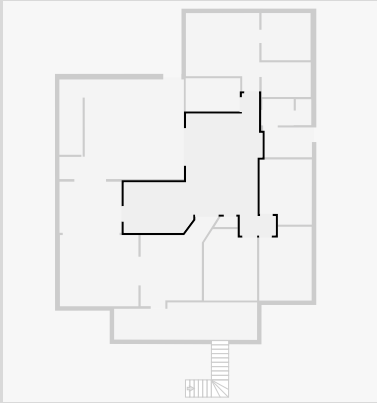

Dining Room

Width: 2.91 m
 Length: 3.54 m
 Area: 10.28 m²
 Perimeter: 12.88 m

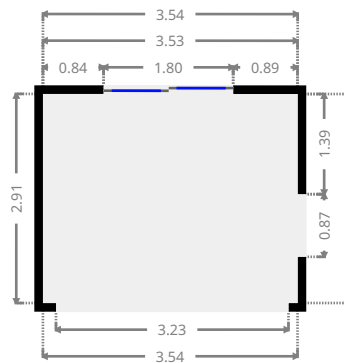
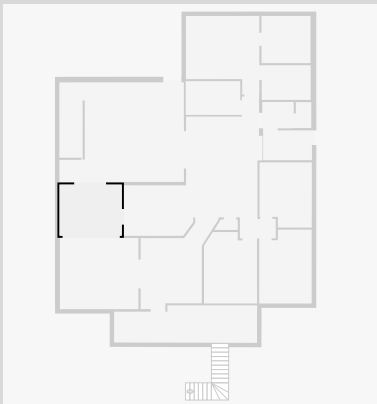

19 Ridgedale Avenue

Living Room

Width: 4.05 m
Length: 4.46 m
Area: 18.06 m²
Perimeter: 17.02 m

