

19 Arthur Street

Ground Floor

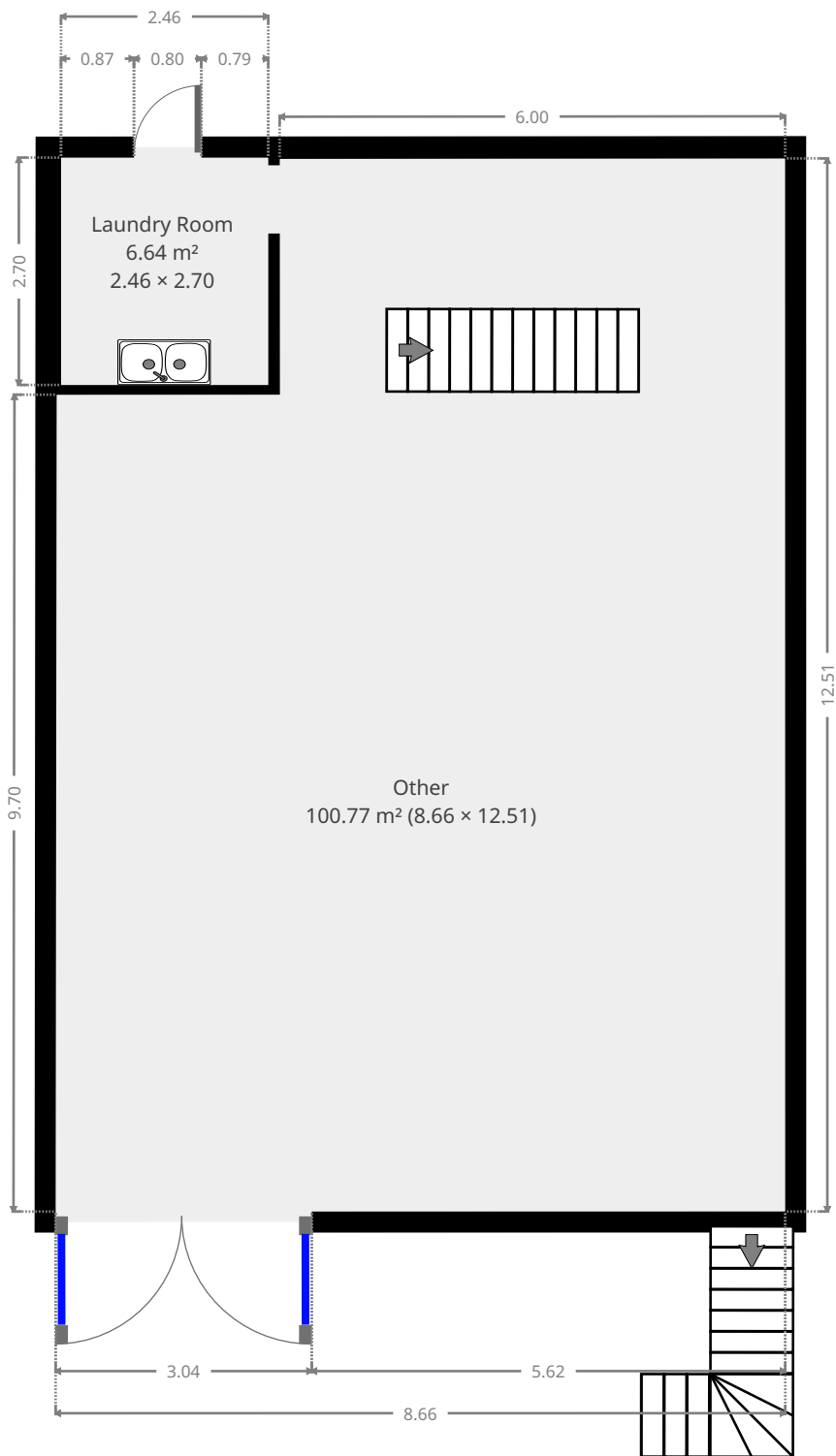

THIS FLOORPLAN IS PROVIDED WITHOUT WARRANTY OF ANY KIND. SENSOPIA DISCLAIMS ANY WARRANTY INCLUDING, WITHOUT LIMITATION, SATISFACTORY QUALITY OR ACCURACY OF DIMENSIONS.

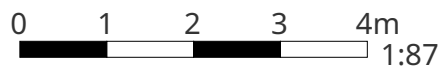

19 Arthur Street

Other

Width: 8.66 m
Length: 12.51 m
Area: 100.77 m²
Perimeter: 42.32 m

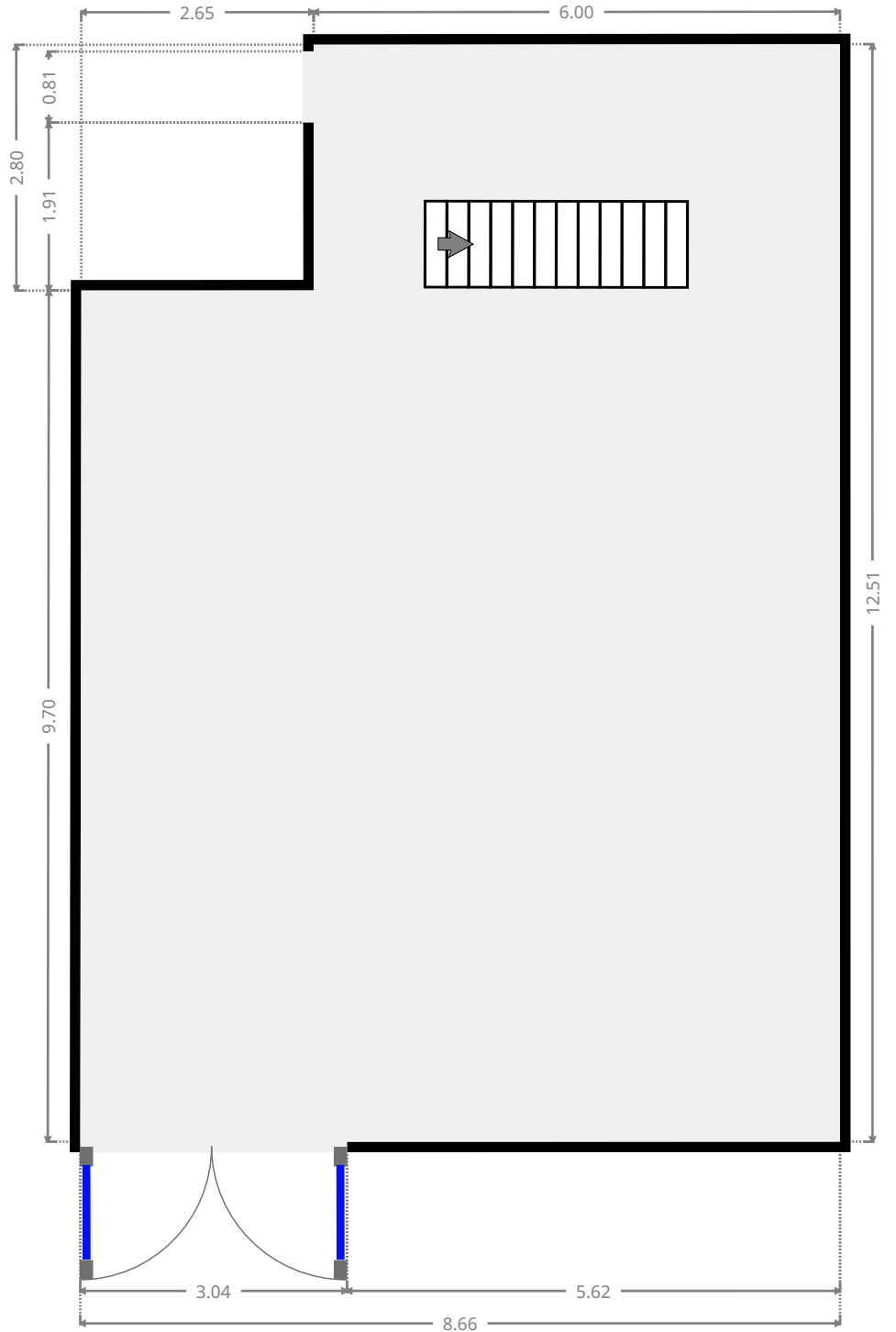
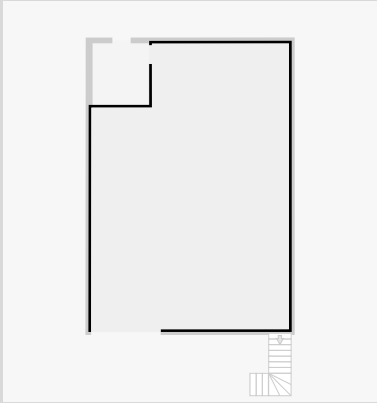

THIS FLOORPLAN IS PROVIDED WITHOUT WARRANTY OF ANY KIND. SENSOPIA DISCLAIMS ANY WARRANTY INCLUDING, WITHOUT LIMITATION, SATISFACTORY QUALITY OR ACCURACY OF DIMENSIONS.



19 Arthur Street

Laundry Room

Width: 2.46 m
Length: 2.70 m
Area: 6.64 m²
Perimeter: 10.32 m

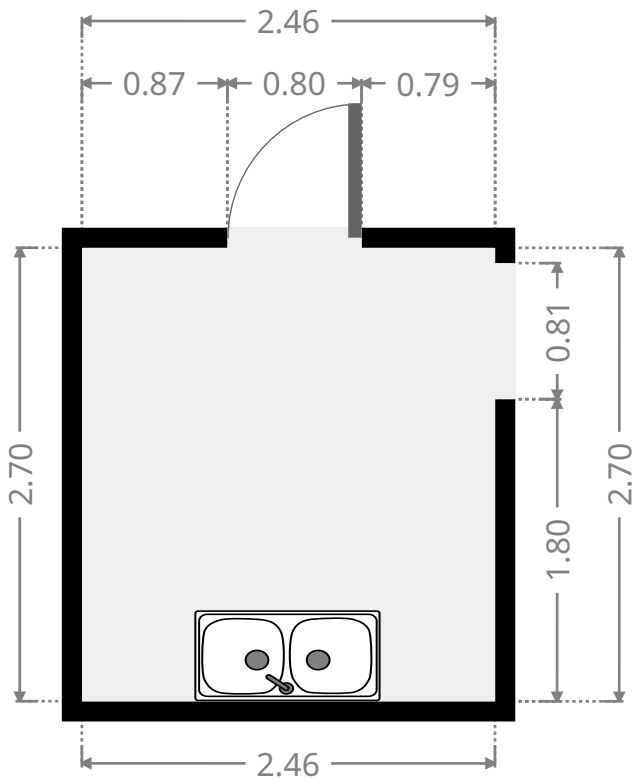
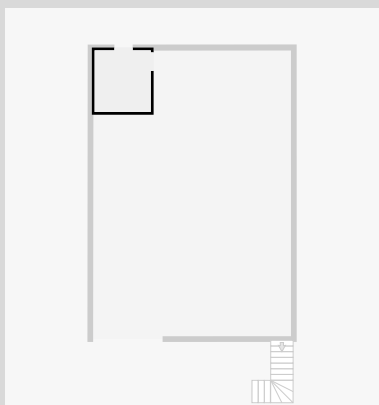

19 Arthur Street

1st Floor

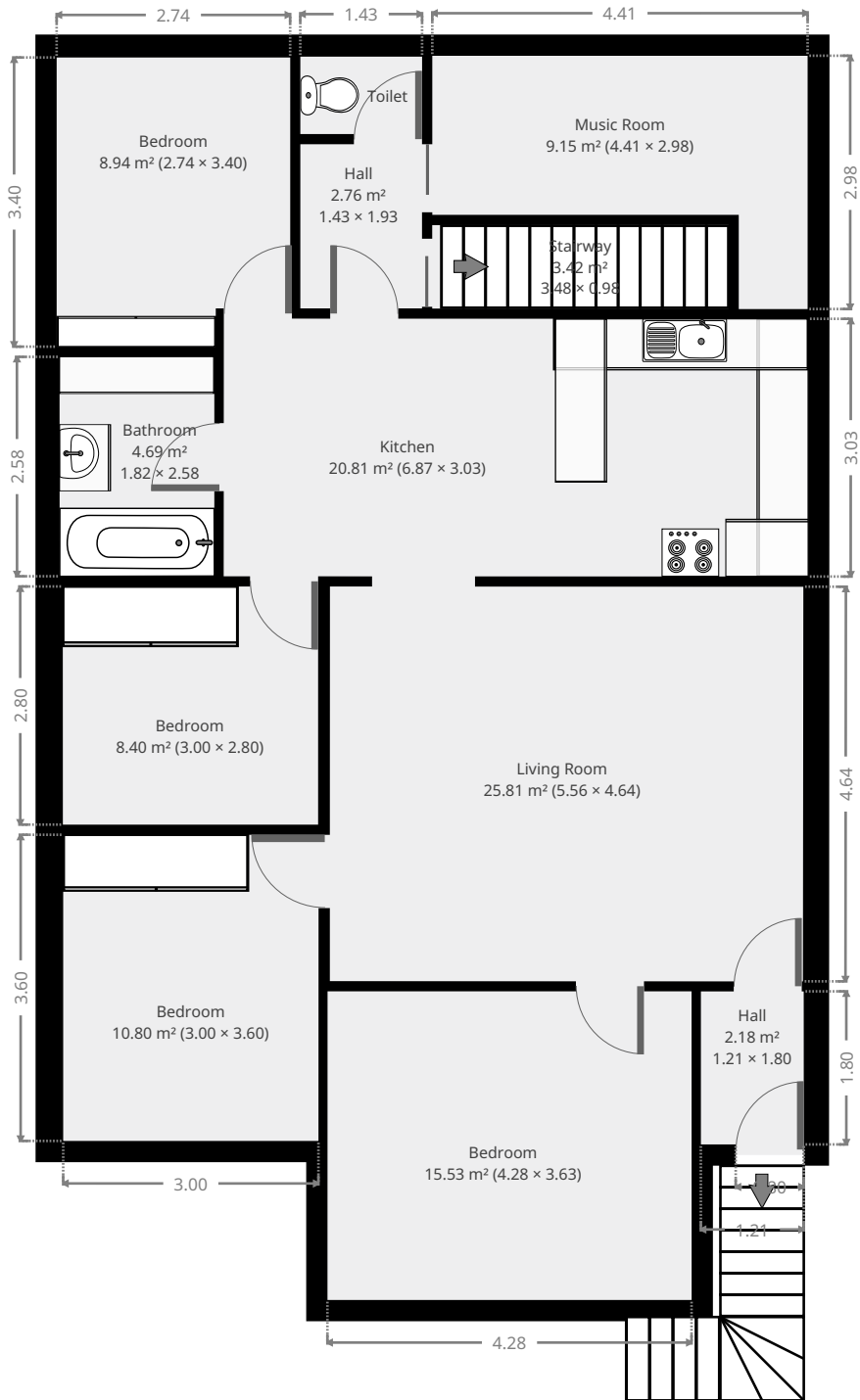

THIS FLOORPLAN IS PROVIDED WITHOUT WARRANTY OF ANY KIND. SENSOPIA DISCLAIMS ANY WARRANTY INCLUDING, WITHOUT LIMITATION, SATISFACTORY QUALITY OR ACCURACY OF DIMENSIONS.



19 Arthur Street

Hall

| | |
|-----------|---------------------|
| Width: | 1.21 m |
| Length: | 1.80 m |
| Area | 2.18 m ² |
| Perimeter | 6.02 m |

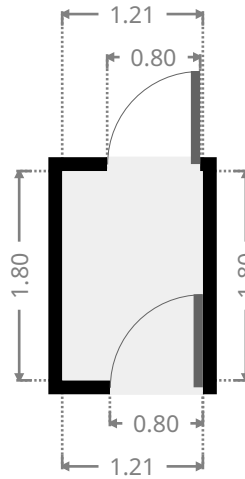
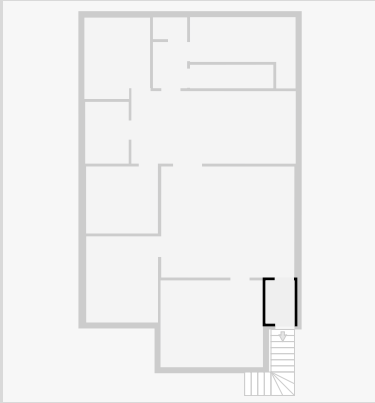

Living Room

| | |
|-----------|----------------------|
| Width: | 4.64 m |
| Length: | 5.56 m |
| Area | 25.81 m ² |
| Perimeter | 20.41 m |

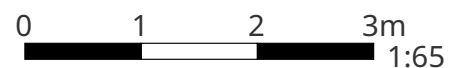
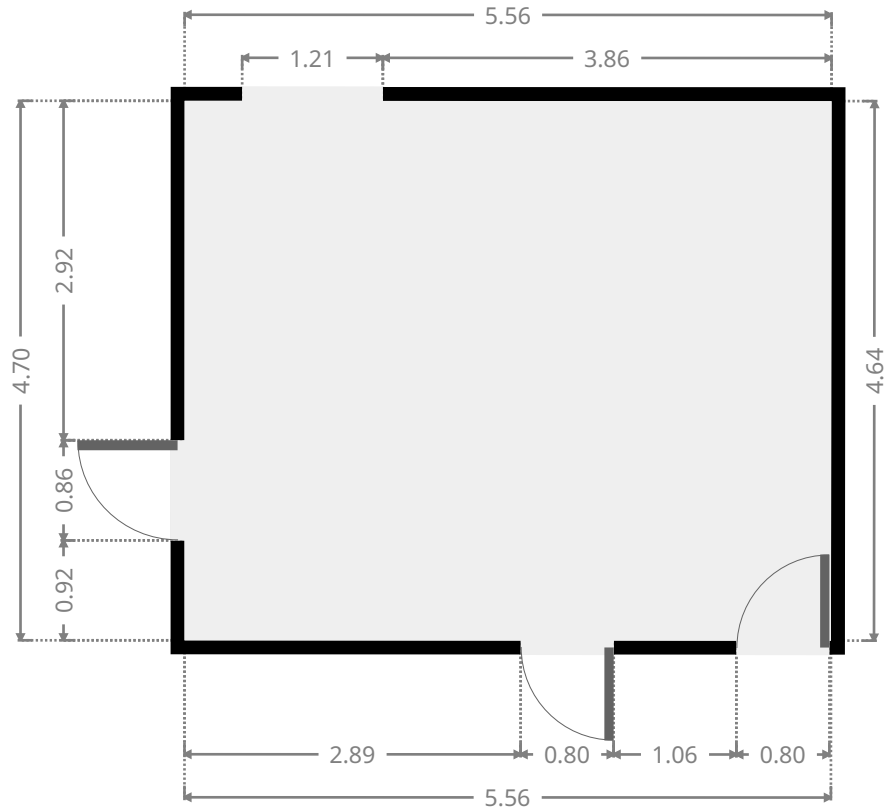
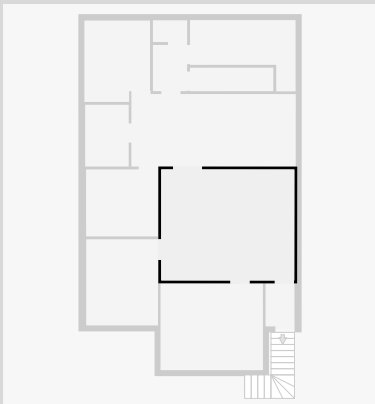

THIS FLOORPLAN IS PROVIDED WITHOUT WARRANTY OF ANY KIND. SENSOPIA DISCLAIMS ANY WARRANTY INCLUDING, WITHOUT LIMITATION, SATISFACTORY QUALITY OR ACCURACY OF DIMENSIONS.

19 Arthur Street

Bedroom

Width: 3.63 m
 Length: 4.28 m
 Area: 15.53 m²
 Perimeter: 15.82 m

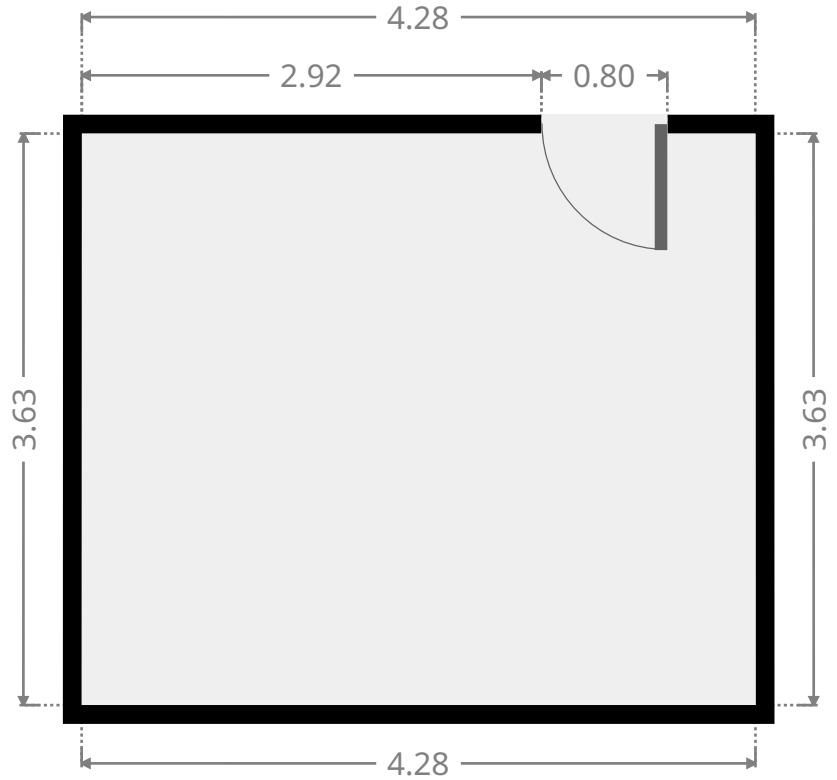
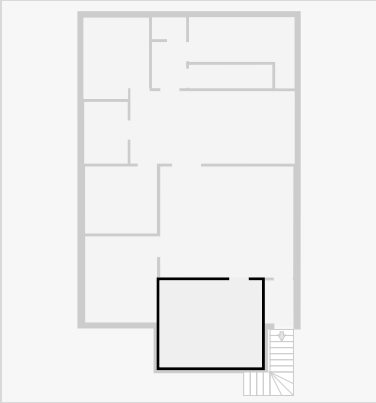

Bedroom

Width: 3.00 m
 Length: 3.60 m
 Area: 10.80 m²
 Perimeter: 13.20 m

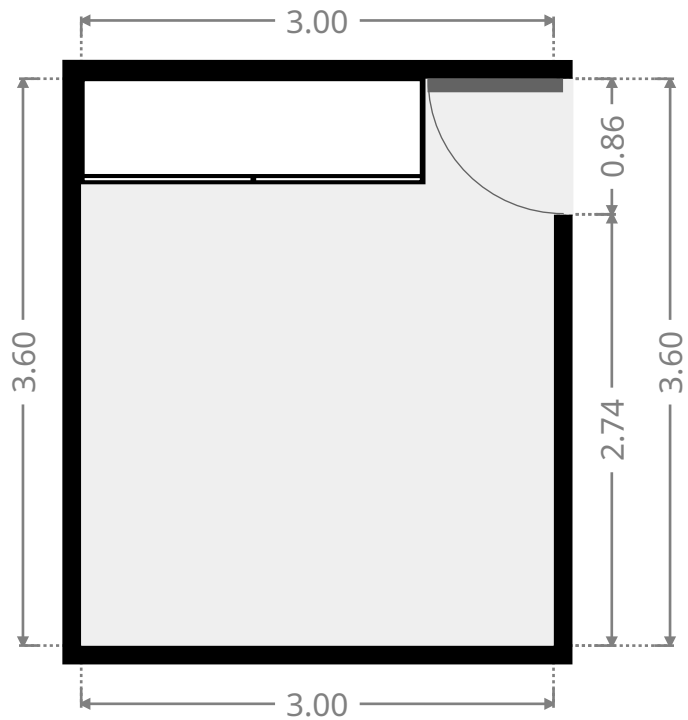
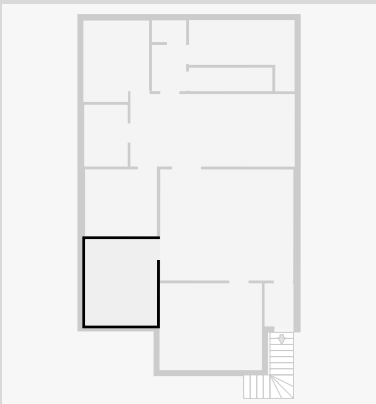

THIS FLOORPLAN IS PROVIDED WITHOUT WARRANTY OF ANY KIND. SENSOPIA DISCLAIMS ANY WARRANTY INCLUDING, WITHOUT LIMITATION, SATISFACTORY QUALITY OR ACCURACY OF DIMENSIONS.

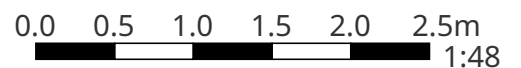

19 Arthur Street

Kitchen

Width: 3.03 m
 Length: 6.87 m
 Area: 20.81 m²
 Perimeter: 19.80 m

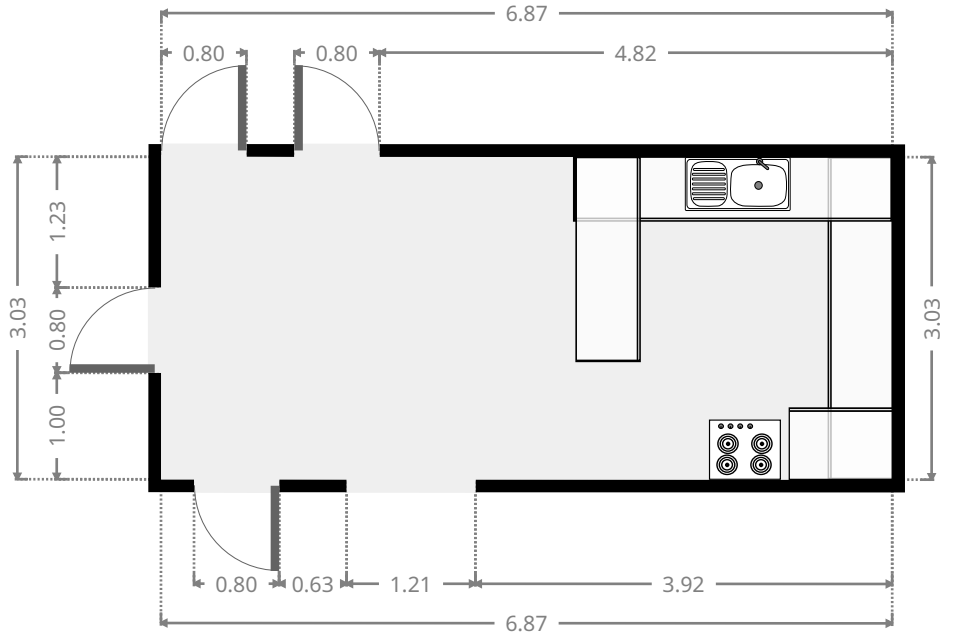
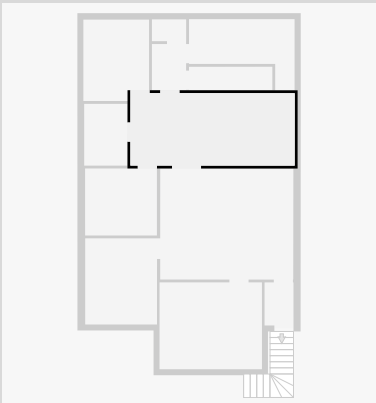

Bedroom

Width: 2.80 m
 Length: 3.00 m
 Area: 8.40 m²
 Perimeter: 11.60 m

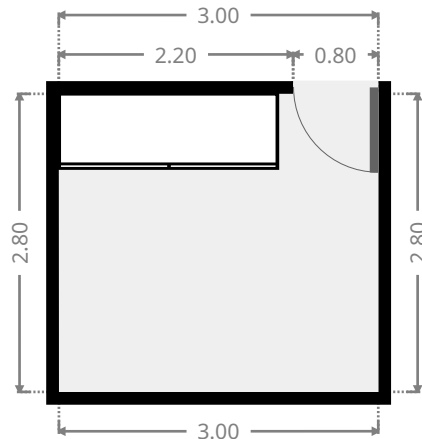
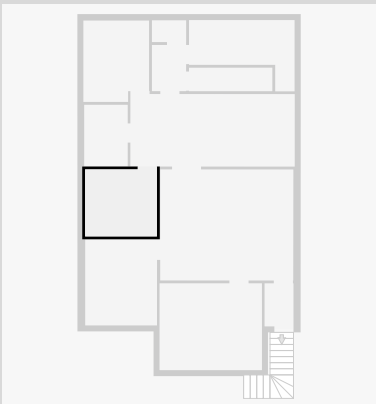

THIS FLOORPLAN IS PROVIDED WITHOUT WARRANTY OF ANY KIND. SENSOPIA DISCLAIMS ANY WARRANTY INCLUDING, WITHOUT LIMITATION, SATISFACTORY QUALITY OR ACCURACY OF DIMENSIONS.



19 Arthur Street

Bathroom

Width: 1.82 m
Length: 2.58 m
Area: 4.69 m²
Perimeter: 8.80 m

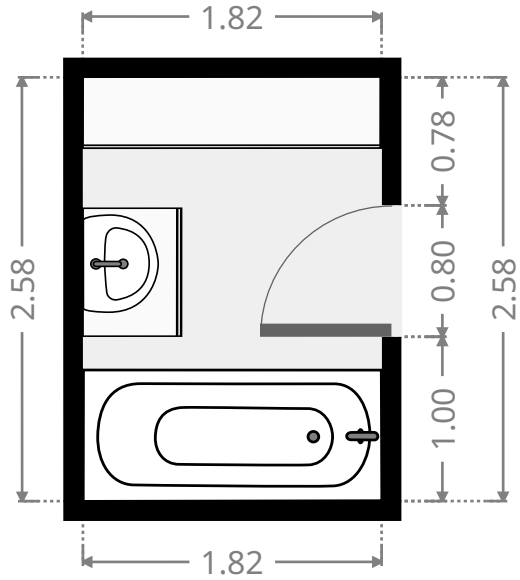
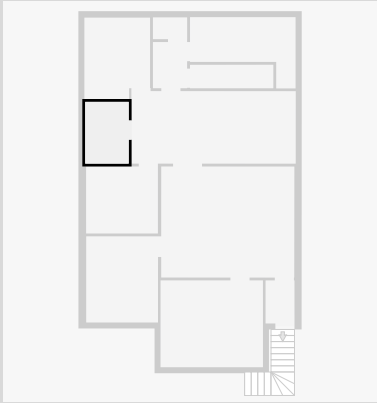

Bedroom

Width: 2.74 m
Length: 3.40 m
Area: 8.94 m²
Perimeter: 12.29 m

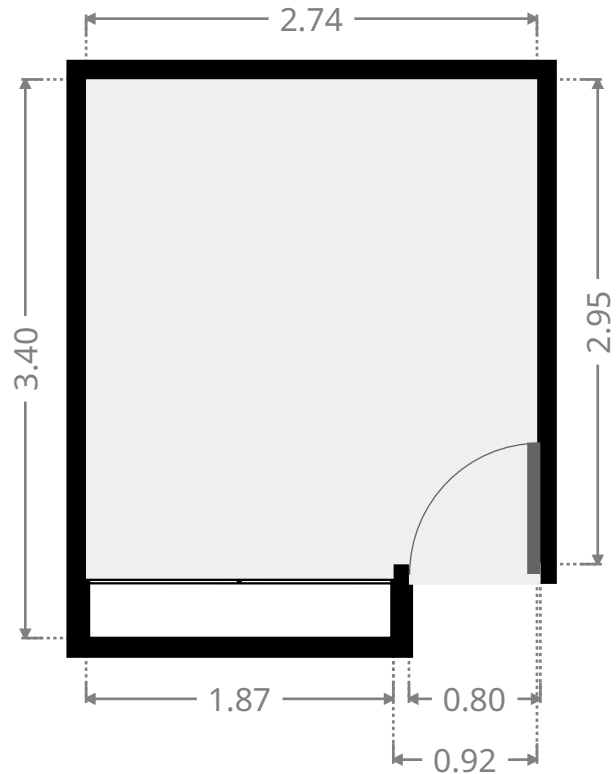
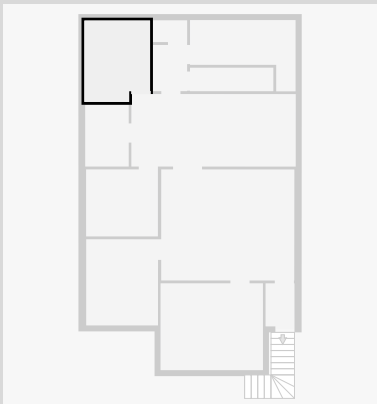

19 Arthur Street

Hall

Width: 1.43 m
Length: 1.93 m
Area: 2.76 m²
Perimeter: 6.72 m

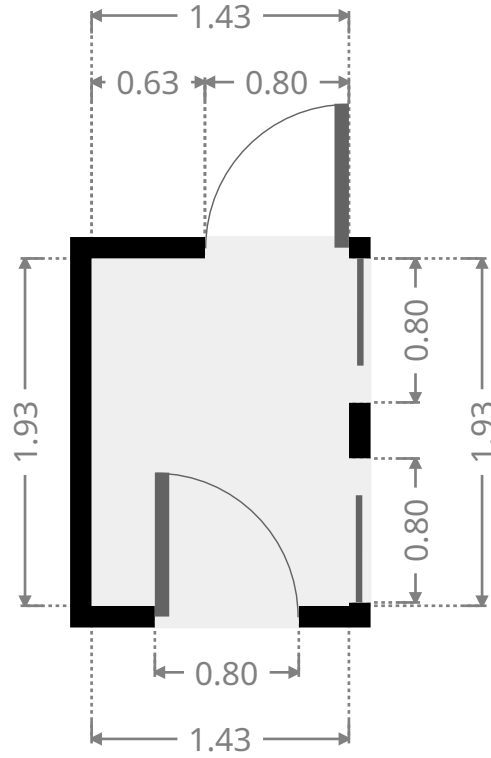
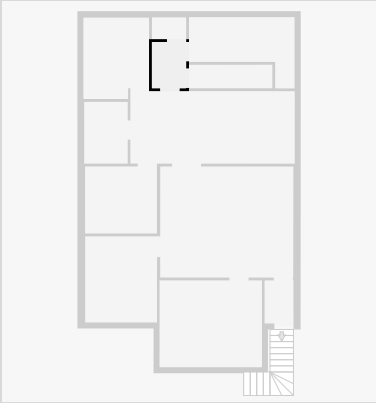

Toilet / Half Bath

Width: 0.91 m
Length: 1.43 m
Area: 1.30 m²
Perimeter: 4.68 m

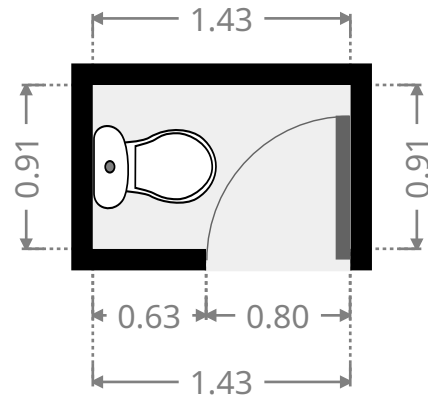
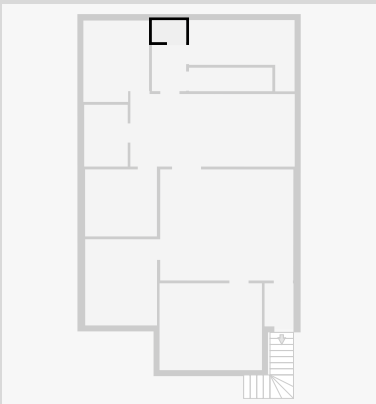

19 Arthur Street

Music Room

Width: 2.98 m
 Length: 4.41 m
 Area: 9.15 m²
 Perimeter: 14.78 m

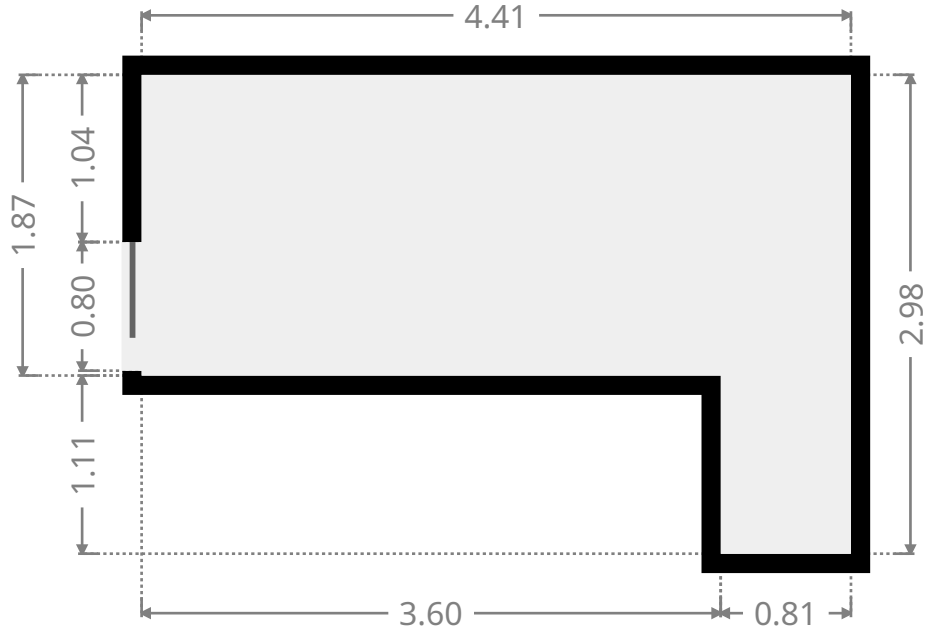
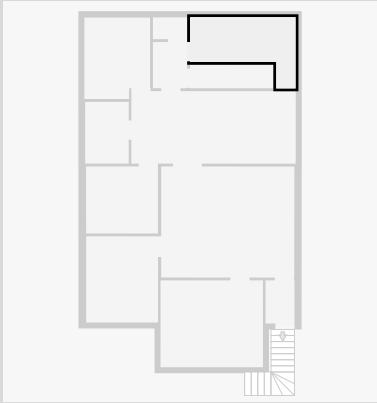

Stairway

Width: 0.98 m
 Length: 3.48 m
 Area: 3.42 m²
 Perimeter: 8.93 m

