

# 188 Wilson Street

## Ground Floor

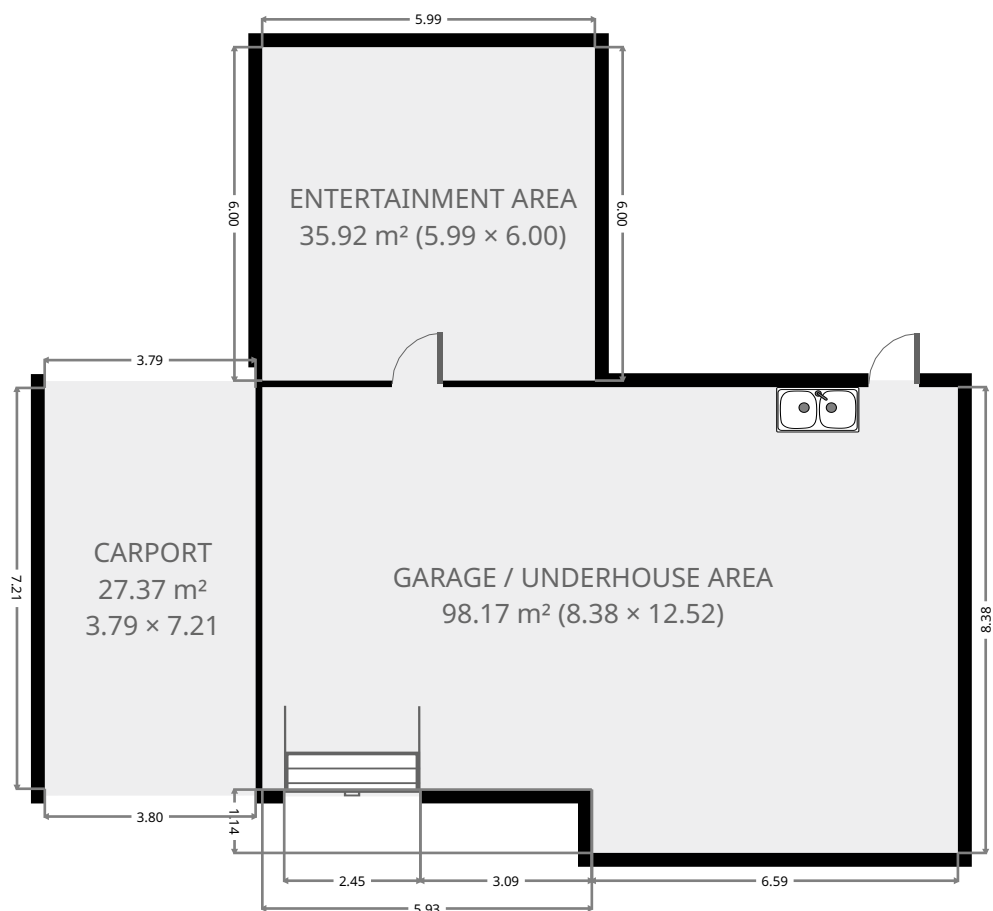

THIS FLOORPLAN IS PROVIDED WITHOUT WARRANTY OF ANY KIND. SENSOPIA DISCLAIMS ANY WARRANTY INCLUDING, WITHOUT LIMITATION, SATISFACTORY QUALITY OR ACCURACY OF DIMENSIONS.

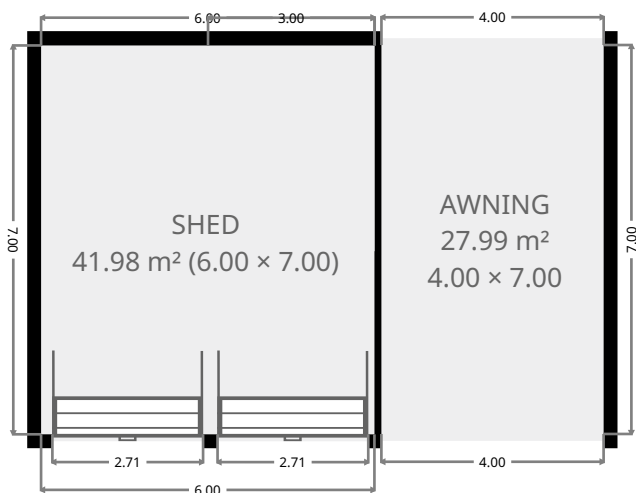

# 188 Wilson Street

## Garage / Underhouse Area

Width: 8.38 m  
Length: 12.52 m  
Area: 98.17 m<sup>2</sup>  
Perimeter: 41.80 m

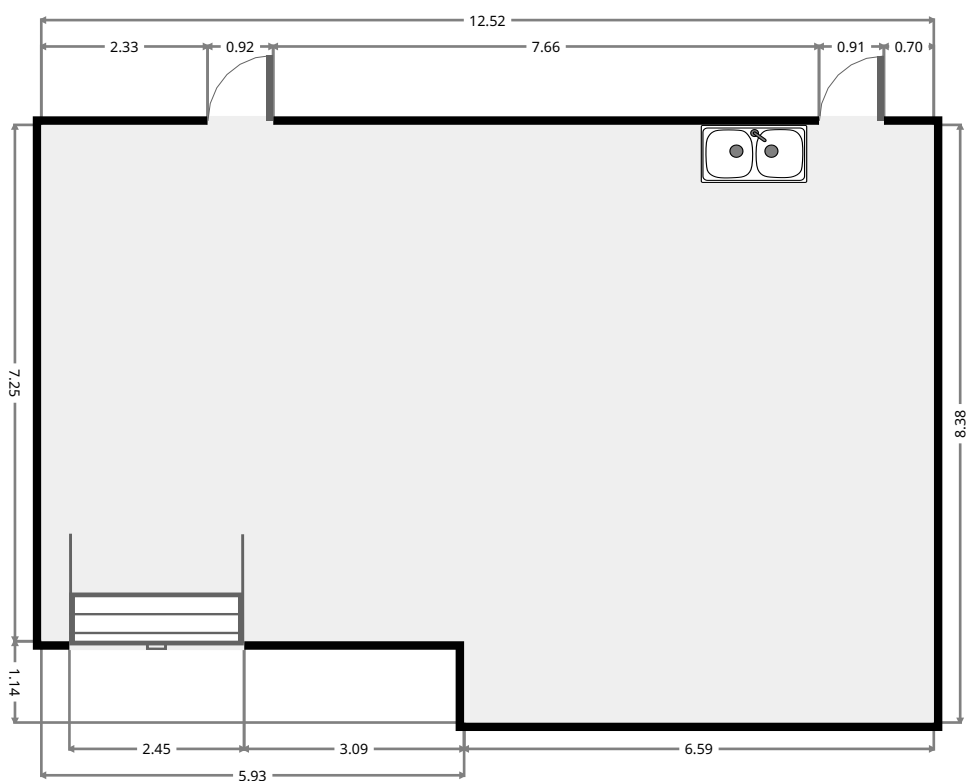
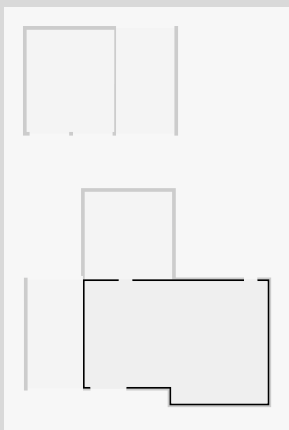

THIS FLOORPLAN IS PROVIDED WITHOUT WARRANTY OF ANY KIND. SENSOPIA DISCLAIMS ANY WARRANTY INCLUDING, WITHOUT LIMITATION, SATISFACTORY QUALITY OR ACCURACY OF DIMENSIONS.

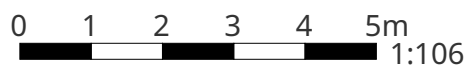

# 188 Wilson Street

## Entertainment Area

Width: 5.99 m  
Length: 6.00 m  
Area: 35.92 m<sup>2</sup>  
Perimeter: 23.97 m

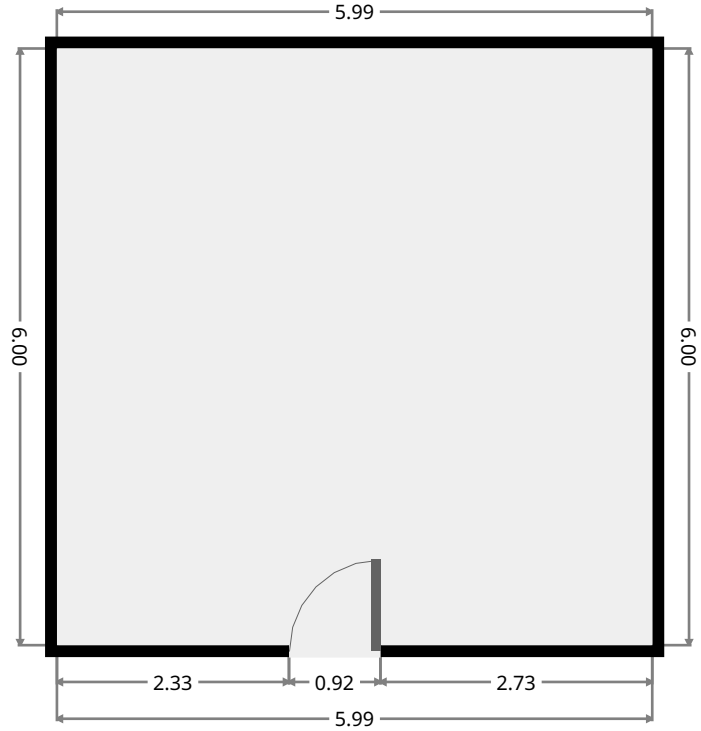
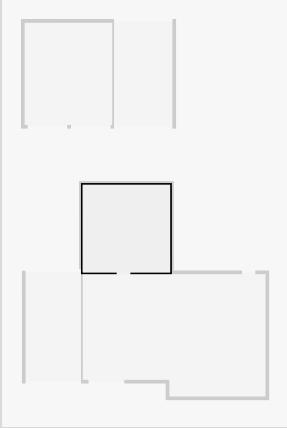

## Carport

Width: 3.79 m  
Length: 7.21 m  
Area: 27.37 m<sup>2</sup>  
Perimeter: 22.01 m

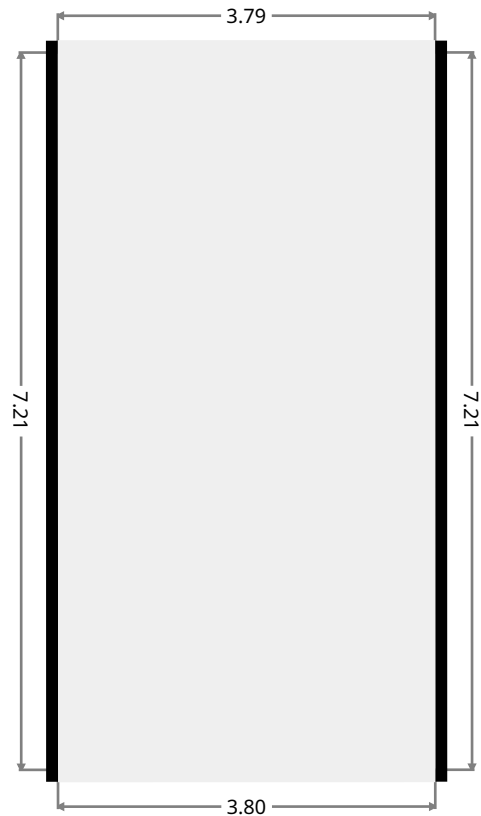
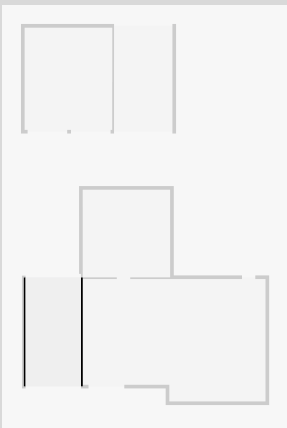

# 188 Wilson Street

## Shed

Width: 6.00 m  
Length: 7.00 m  
Area: 41.98 m<sup>2</sup>  
Perimeter: 25.99 m

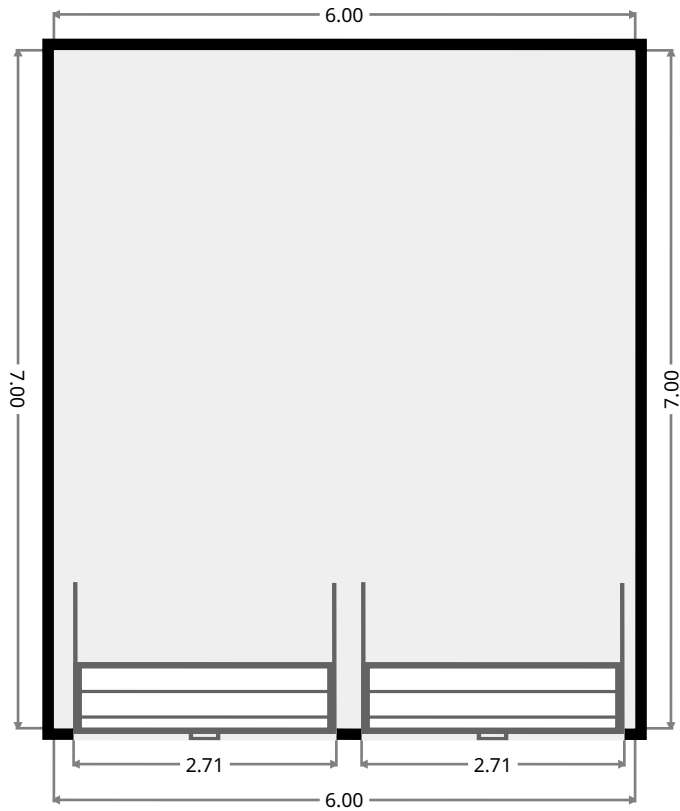
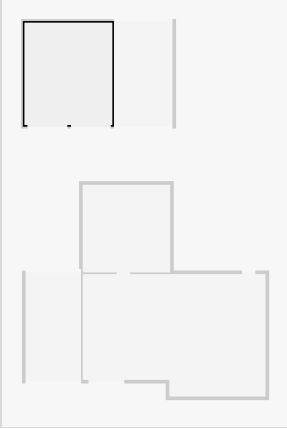

## Awning

Width: 4.00 m  
Length: 7.00 m  
Area: 27.99 m<sup>2</sup>  
Perimeter: 22.00 m

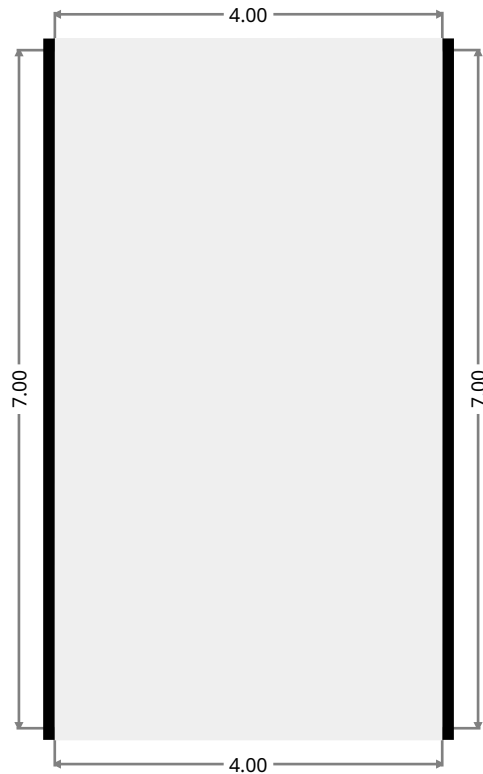
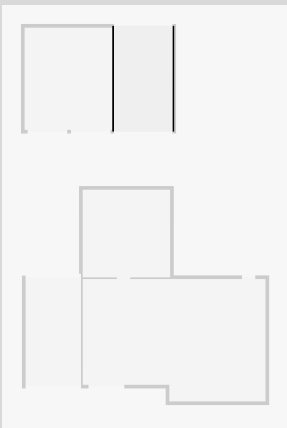

# 188 Wilson Street

## Mezzanine Floor

Width: 3.00 m  
Length: 3.70 m  
Area: 11.09 m<sup>2</sup>  
Perimeter: 13.40 m

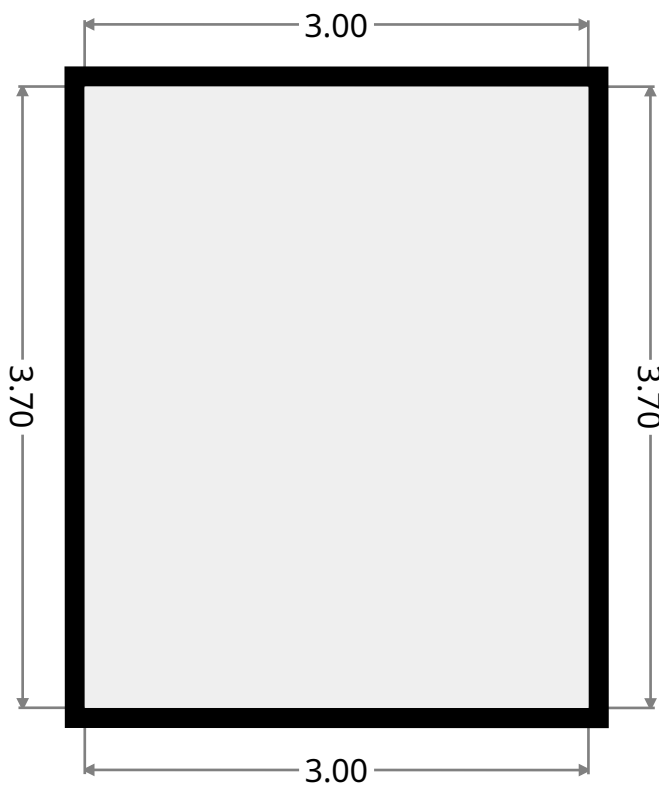
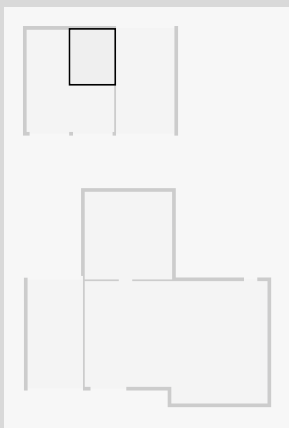

# 188 Wilson Street

## 1st Floor

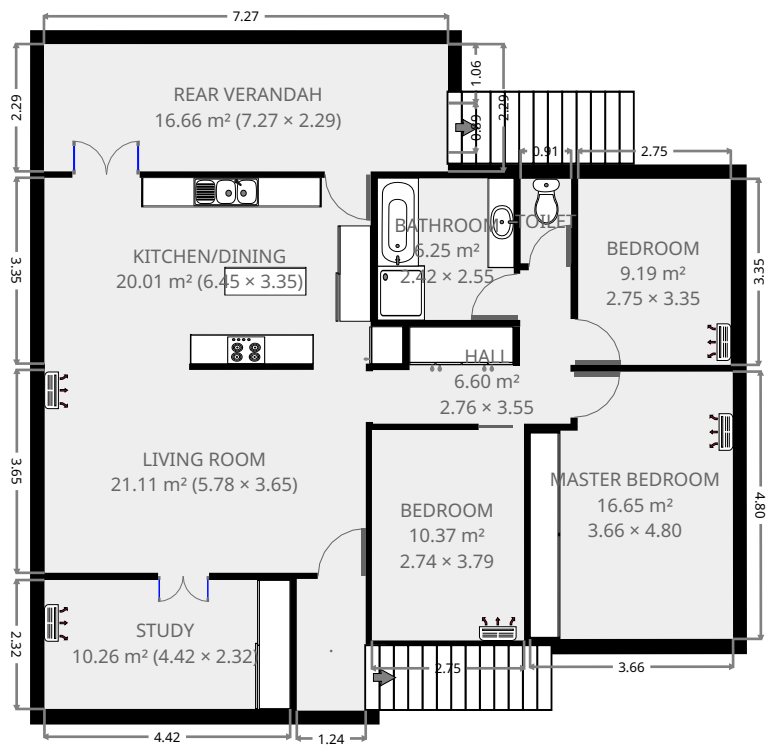

THIS FLOORPLAN IS PROVIDED WITHOUT WARRANTY OF ANY KIND. SENSOPIA DISCLAIMS ANY WARRANTY INCLUDING, WITHOUT LIMITATION, SATISFACTORY QUALITY OR ACCURACY OF DIMENSIONS.



# 188 Wilson Street

## Living Room

Width: 3.65 m  
 Length: 5.78 m  
 Area: 21.11 m<sup>2</sup>  
 Perimeter: 18.86 m

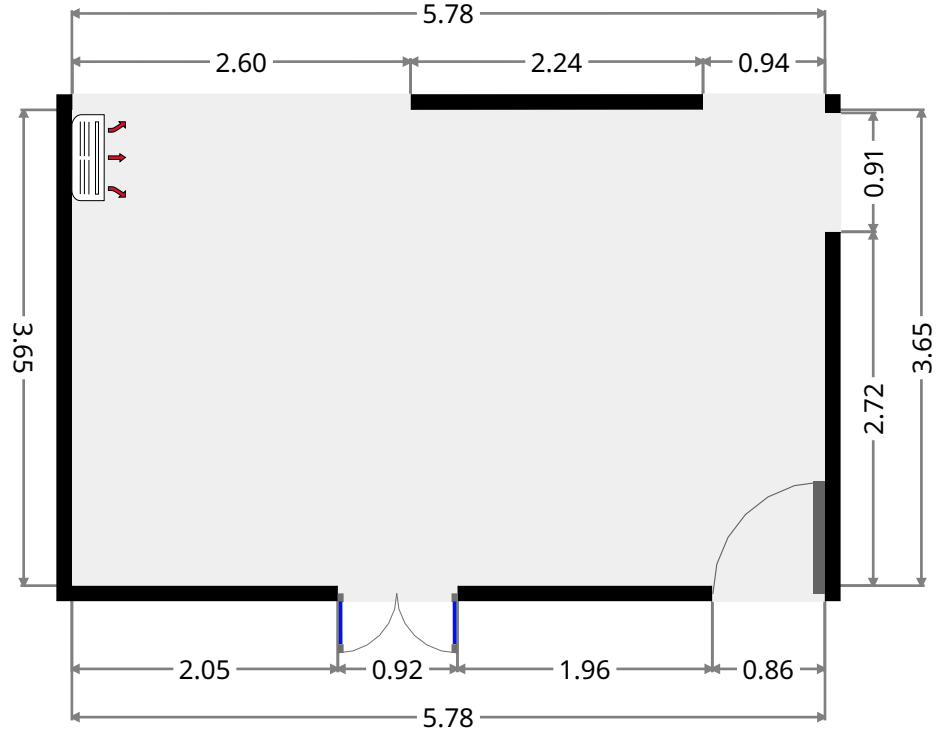
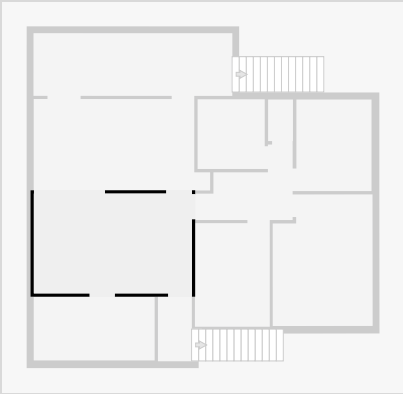

## Study

Width: 2.32 m  
 Length: 4.42 m  
 Area: 10.26 m<sup>2</sup>  
 Perimeter: 13.48 m

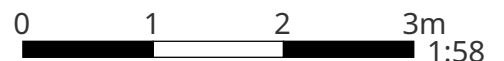
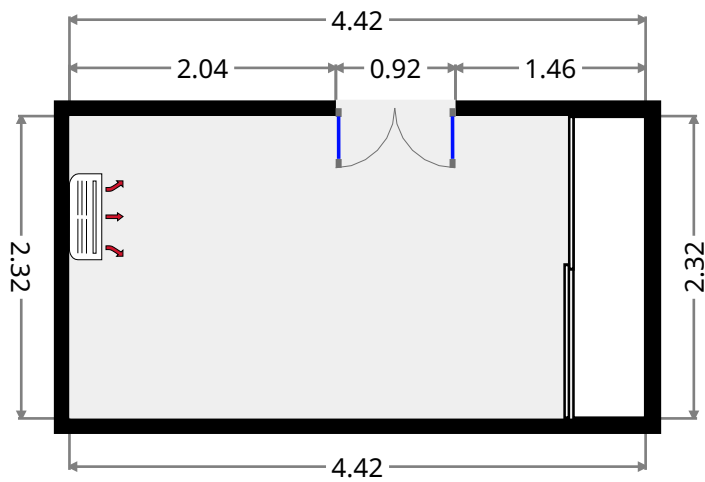
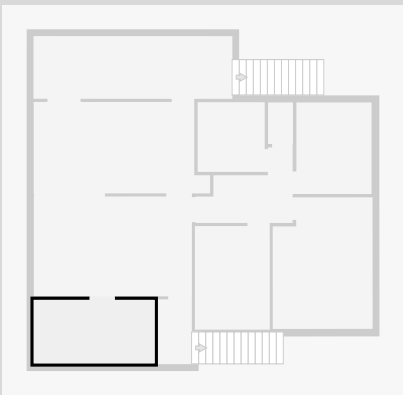

# 188 Wilson Street

## Kitchen/Dining

Width: 3.35 m  
 Length: 6.45 m  
 Area: 20.01 m<sup>2</sup>  
 Perimeter: 19.59 m

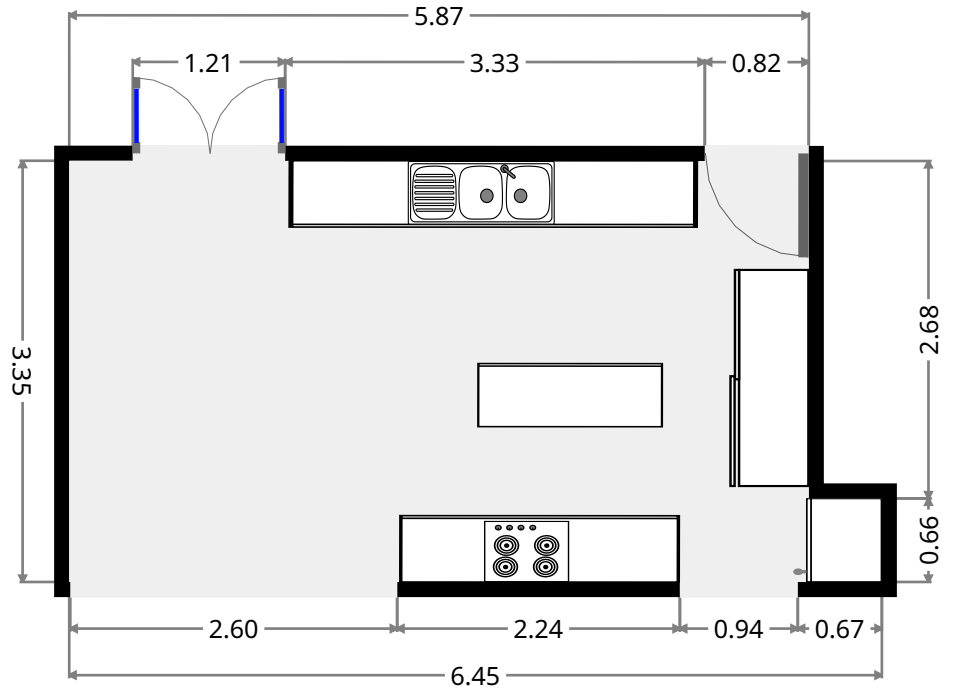
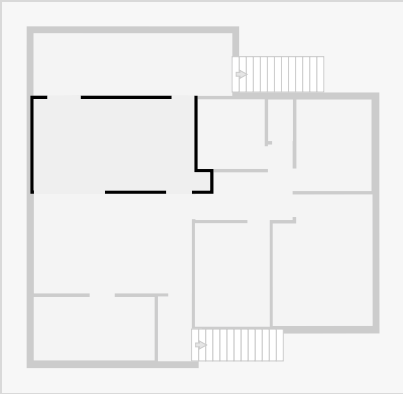

## Hall

Width: 2.76 m  
 Length: 3.55 m  
 Area: 6.60 m<sup>2</sup>  
 Perimeter: 12.63 m

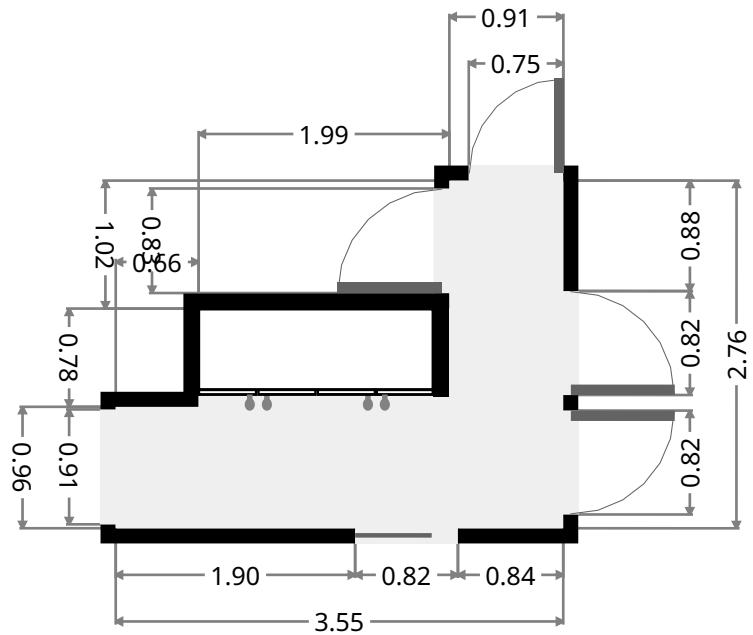
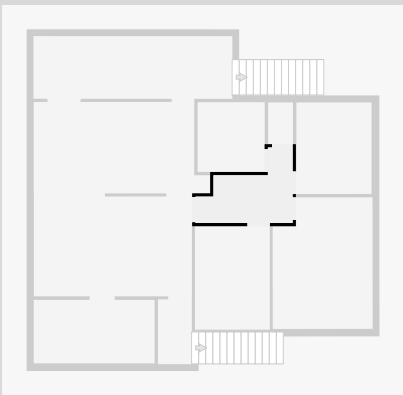

THIS FLOORPLAN IS PROVIDED WITHOUT WARRANTY OF ANY KIND. SENSOPIA DISCLAIMS ANY WARRANTY INCLUDING, WITHOUT LIMITATION, SATISFACTORY QUALITY OR ACCURACY OF DIMENSIONS.

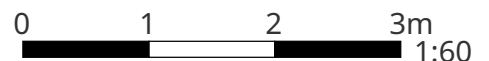



# 188 Wilson Street

## Bedroom

Width: 2.74 m  
 Length: 3.79 m  
 Area: 10.37 m<sup>2</sup>  
 Perimeter: 13.05 m

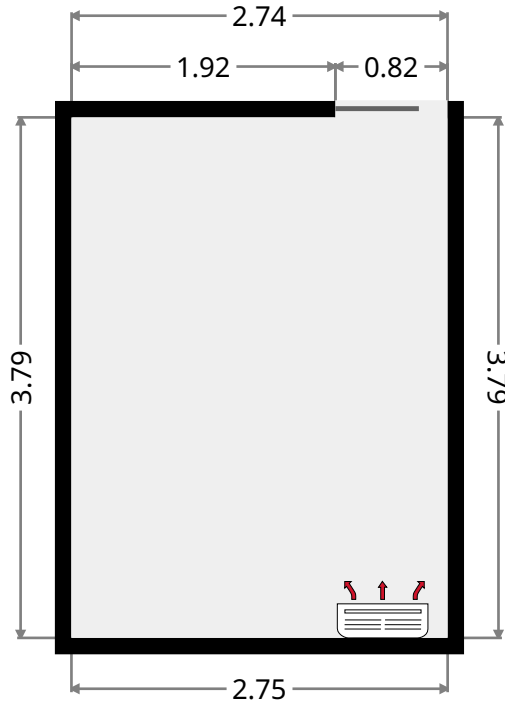
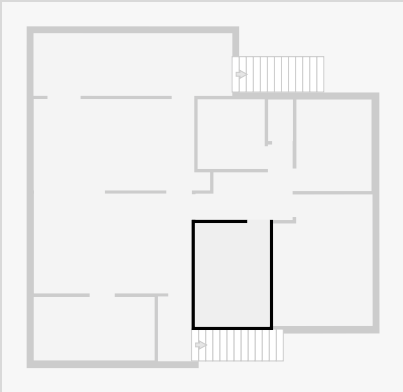

## Master Bedroom

Width: 3.66 m  
 Length: 4.80 m  
 Area: 16.65 m<sup>2</sup>  
 Perimeter: 16.92 m

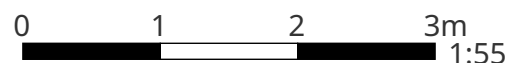
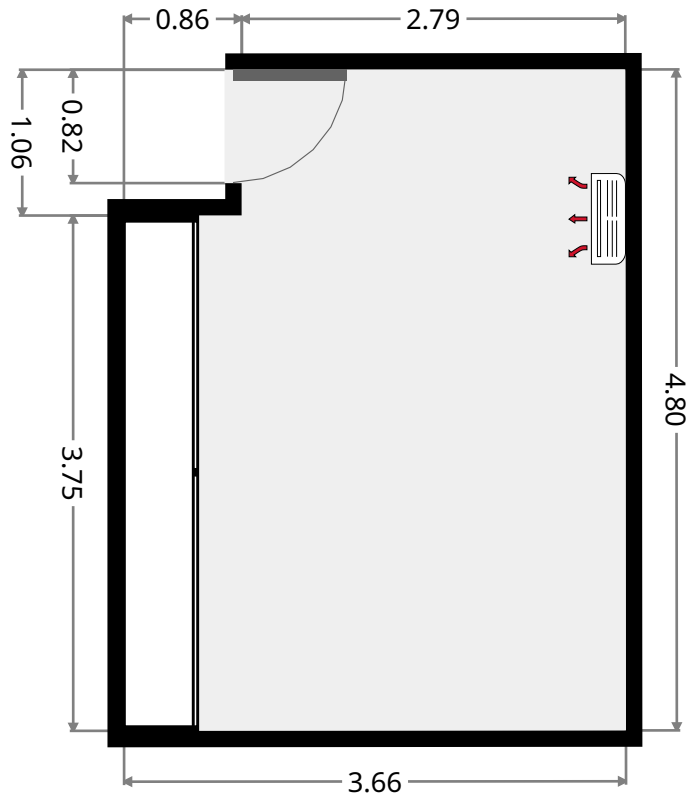
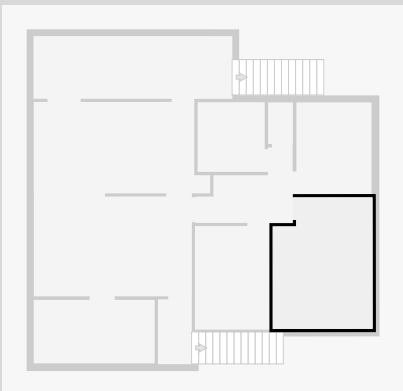

THIS FLOORPLAN IS PROVIDED WITHOUT WARRANTY OF ANY KIND. SENSOPIA DISCLAIMS ANY WARRANTY INCLUDING, WITHOUT LIMITATION, SATISFACTORY QUALITY OR ACCURACY OF DIMENSIONS.

# 188 Wilson Street

## Bedroom

Width: 2.75 m  
 Length: 3.35 m  
 Area: 9.19 m<sup>2</sup>  
 Perimeter: 12.19 m

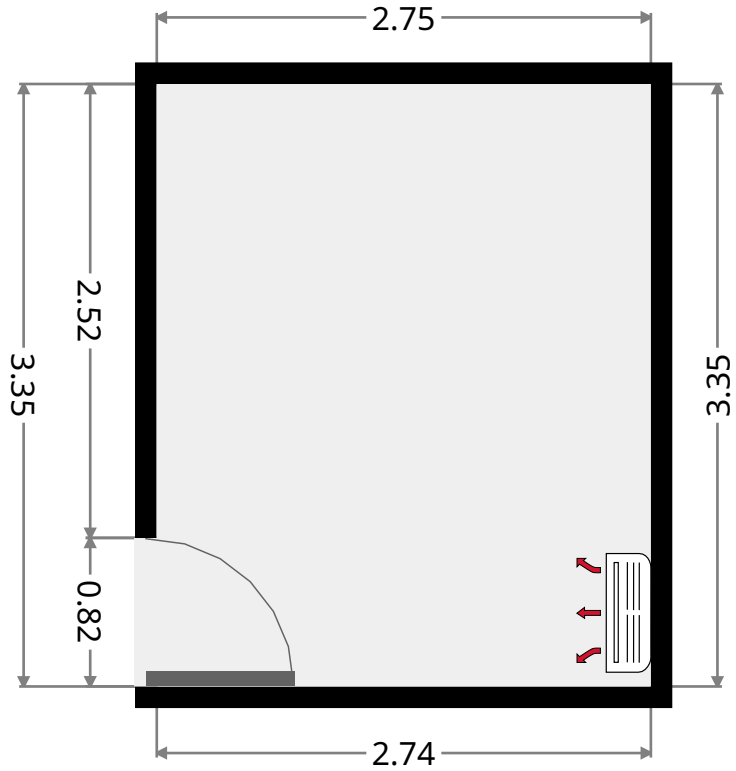
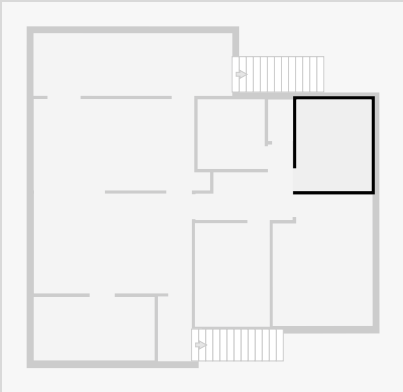

## Toilet

Width: 0.91 m  
 Length: 1.52 m  
 Area: 1.38 m<sup>2</sup>  
 Perimeter: 4.86 m

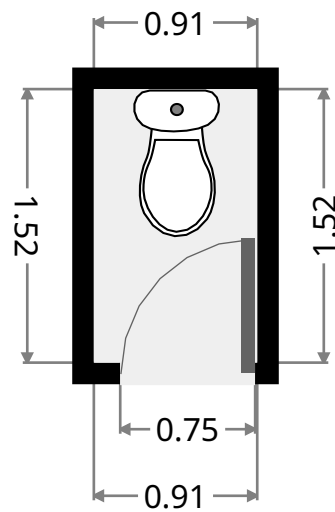
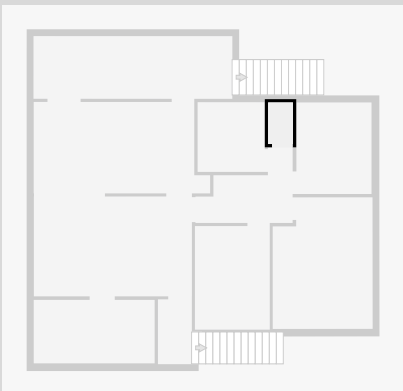

# 188 Wilson Street

## Bathroom

Width: 2.42 m  
Length: 2.55 m  
Area: 6.25 m<sup>2</sup>  
Perimeter: 10.00 m

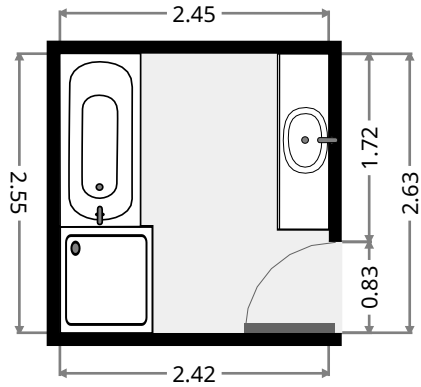
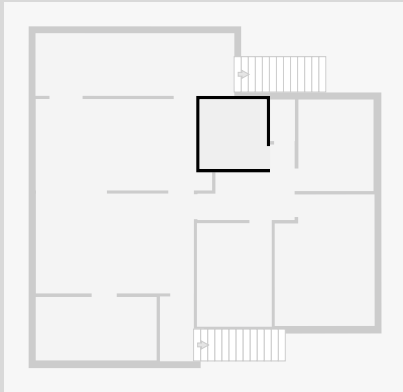

## Rear Verandah

Width: 2.29 m  
Length: 7.27 m  
Area: 16.66 m<sup>2</sup>  
Perimeter: 19.12 m

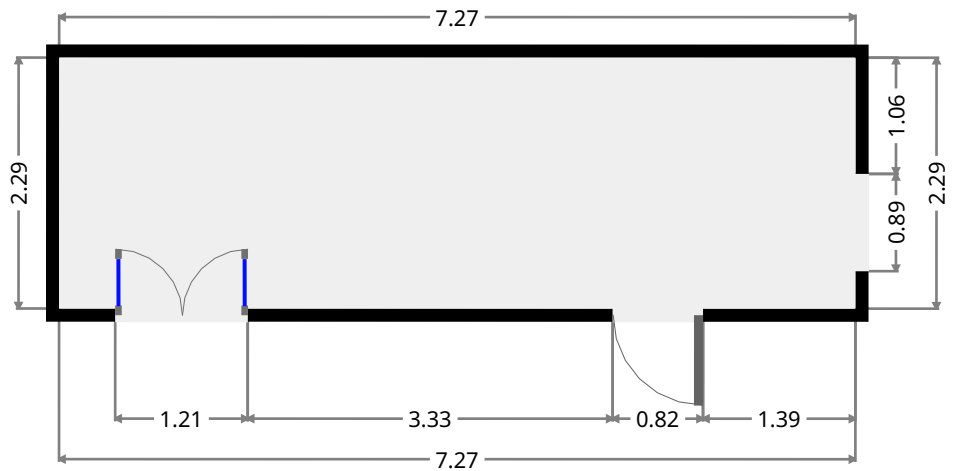
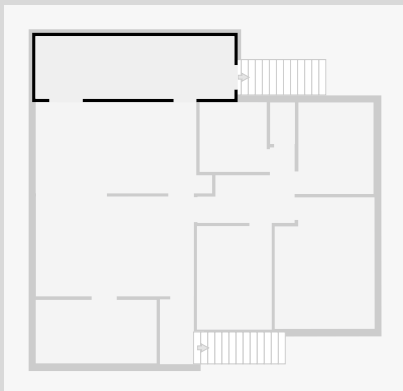

# 188 Wilson Street

•  
Width: 1.24 m  
Length: 2.38 m  
Area: 2.94 m<sup>2</sup>  
Perimeter: 7.22 m

