

Ground Floor

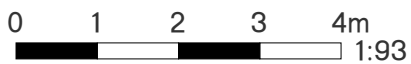
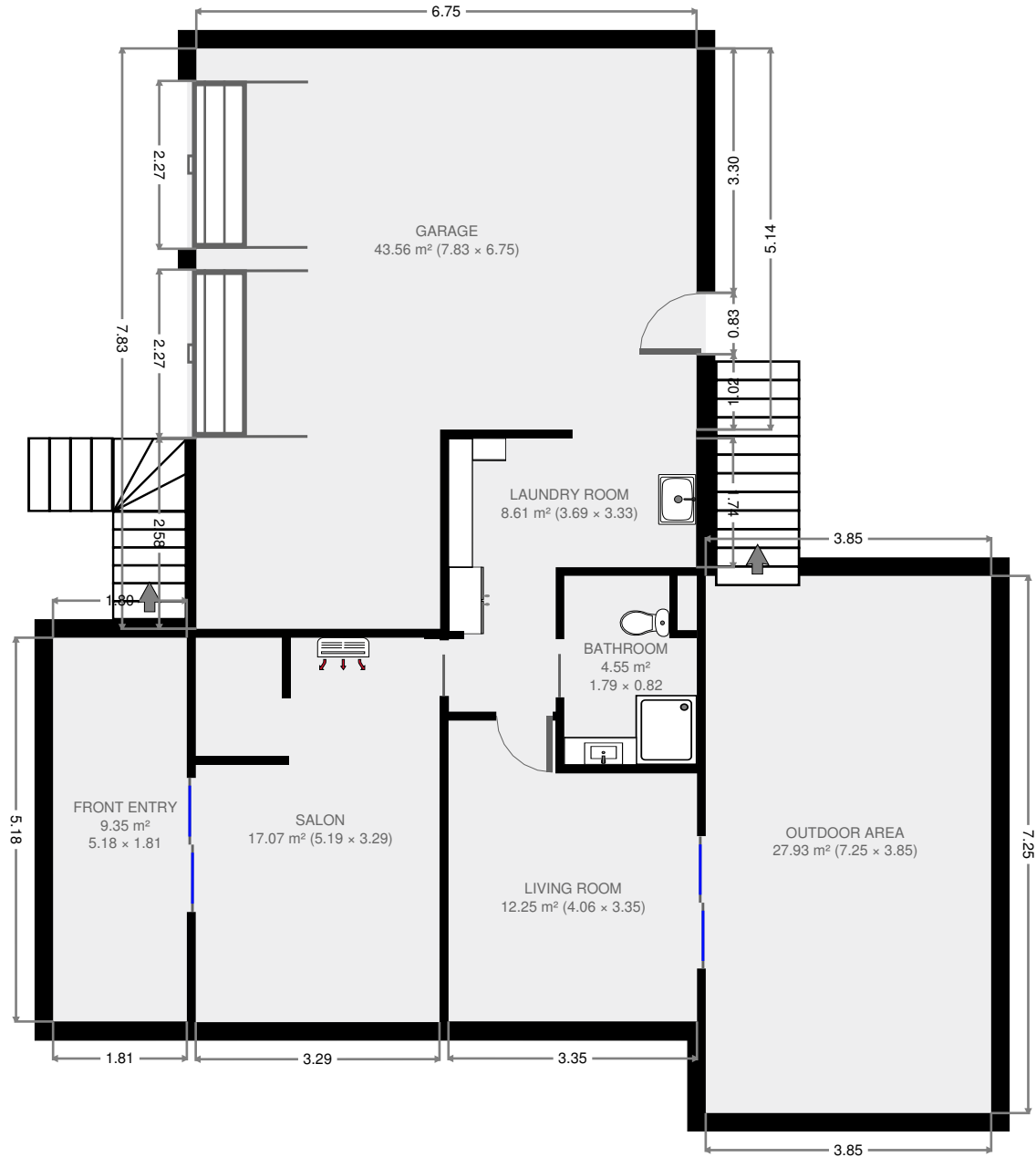

184 German Street

THIS FLOORPLAN IS PROVIDED WITHOUT WARRANTY OF ANY KIND. SENSOPIA DISCLAIMS ANY WARRANTY INCLUDING, WITHOUT LIMITATION, SATISFACTORY QUALITY OR ACCURACY OF DIMENSIONS.

Salon

Width: 3.29 m
 Length: 5.19 m
 Area: 17.07 m²
 Perimeter: 16.96 m

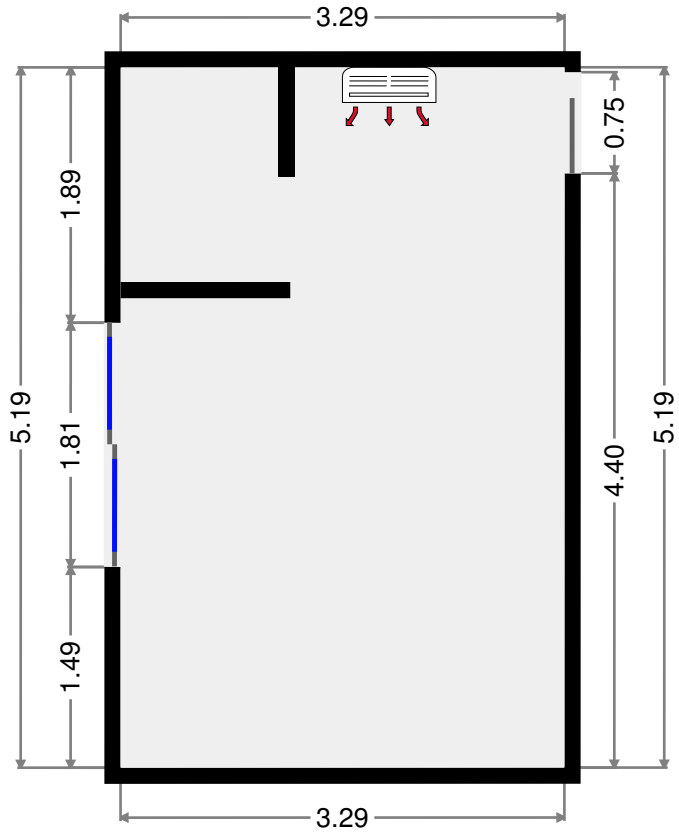
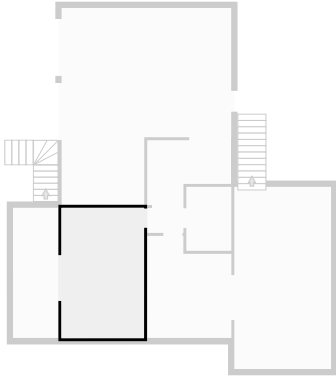

Laundry Room

Width: 3.33 m
 Length: 3.69 m
 Area: 8.61 m²
 Perimeter: 14.05 m

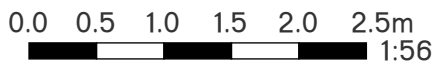
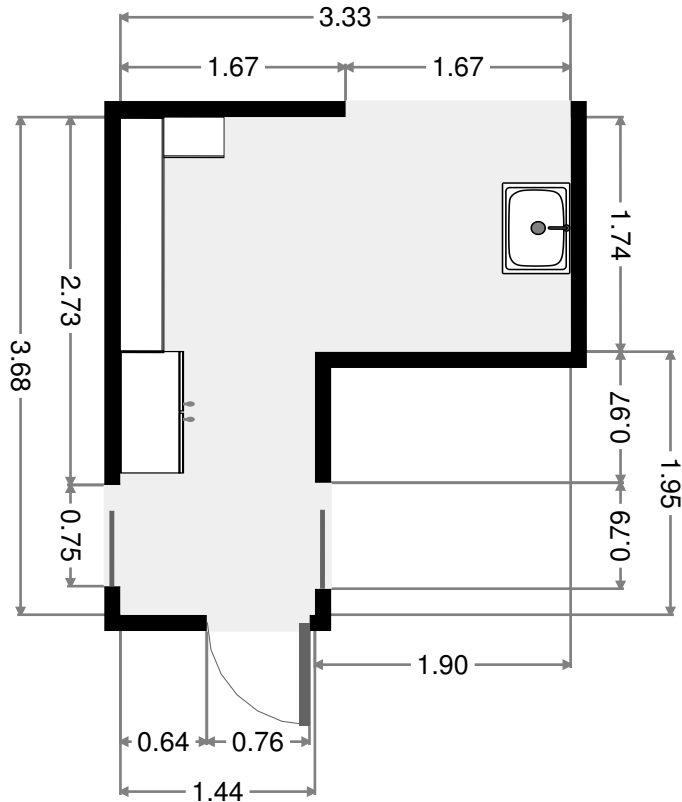
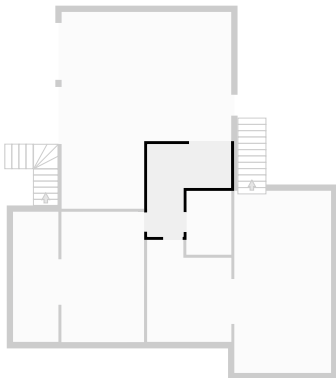

THIS FLOORPLAN IS PROVIDED WITHOUT WARRANTY OF ANY KIND. SENSOPIA DISCLAIMS ANY WARRANTY INCLUDING, WITHOUT LIMITATION, SATISFACTORY QUALITY OR ACCURACY OF DIMENSIONS.

Bathroom

Width: 0.82 m
 Length: 1.79 m
 Area: 4.55 m²
 Perimeter: 8.67 m

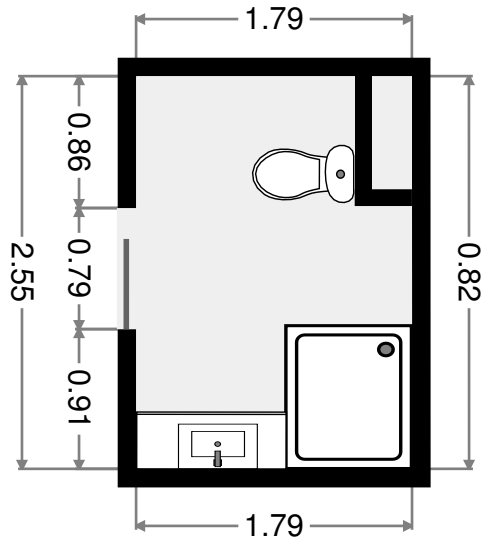
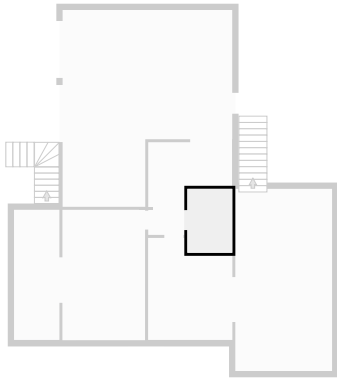

Living Room

Width: 3.35 m
 Length: 4.06 m
 Area: 12.25 m²
 Perimeter: 14.83 m

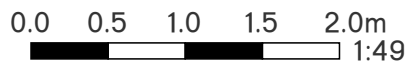
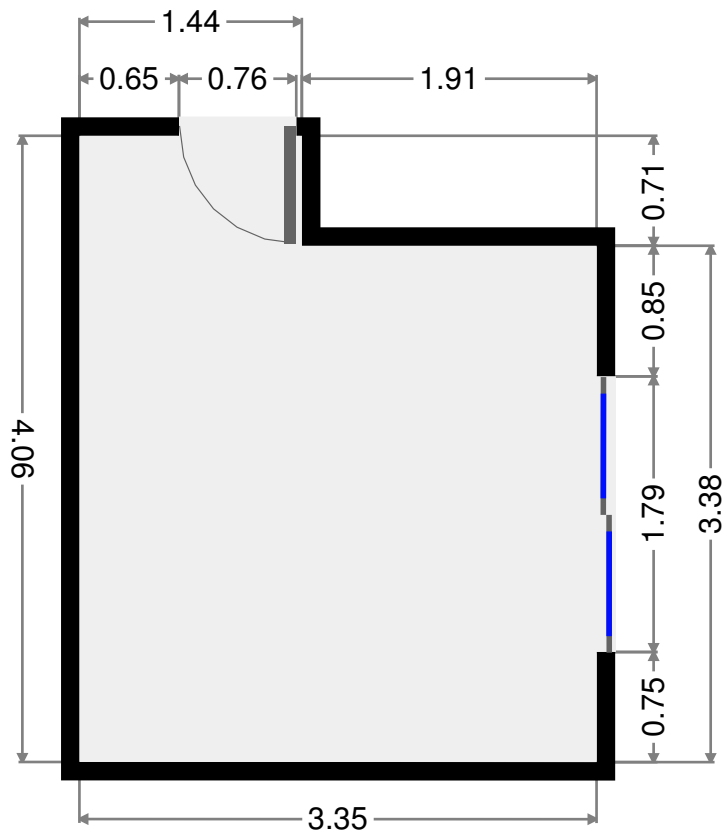
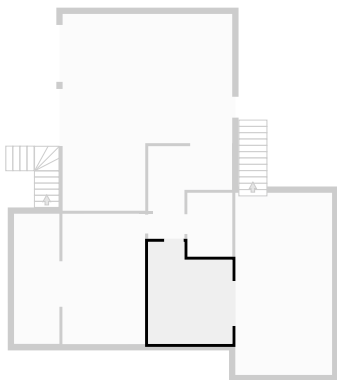

THIS FLOORPLAN IS PROVIDED WITHOUT WARRANTY OF ANY KIND. SENSOPIA DISCLAIMS ANY WARRANTY INCLUDING, WITHOUT LIMITATION, SATISFACTORY QUALITY OR ACCURACY OF DIMENSIONS.

Garage

Width: 6.75 m
 Length: 7.83 m
 Area: 43.56 m²
 Perimeter: 29.16 m

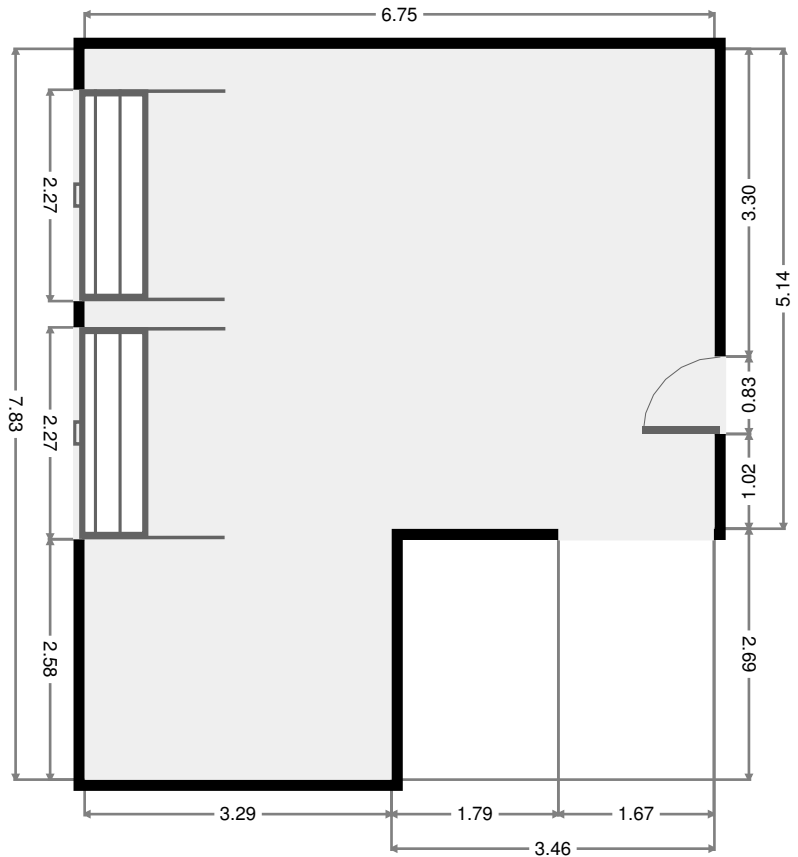
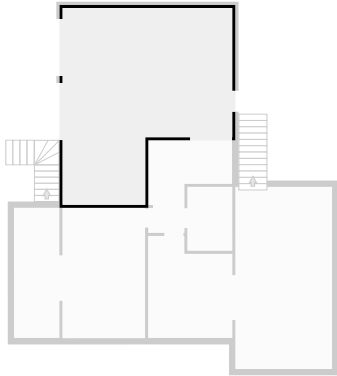

Outdoor Area

Width: 3.85 m
 Length: 7.25 m
 Area: 27.93 m²
 Perimeter: 22.20 m

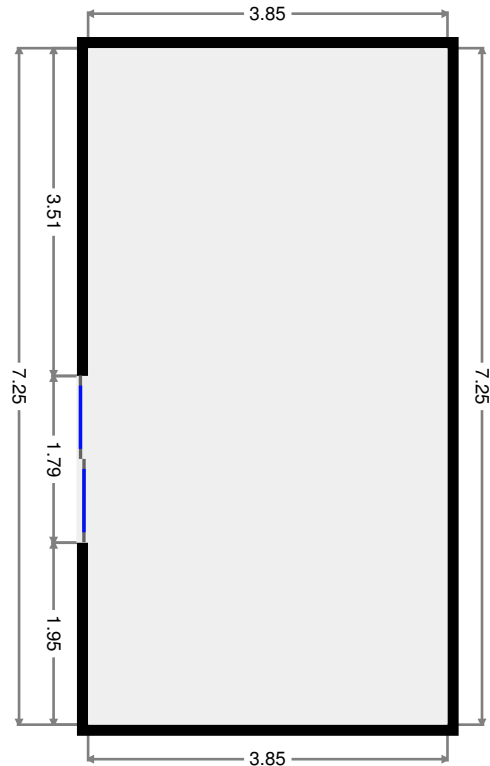
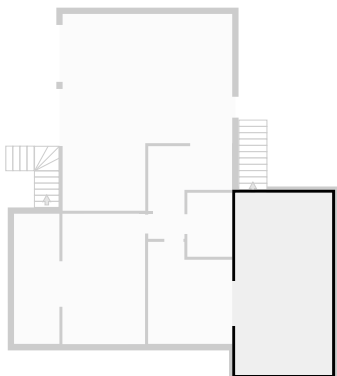

THIS FLOORPLAN IS PROVIDED WITHOUT WARRANTY OF ANY KIND. SENSOPIA DISCLAIMS ANY WARRANTY INCLUDING, WITHOUT LIMITATION, SATISFACTORY QUALITY OR ACCURACY OF DIMENSIONS.

Front Entry

Width: 1.81 m
Length: 5.18 m
Area: 9.35 m²
Perimeter: 13.97 m

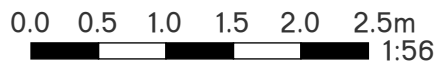
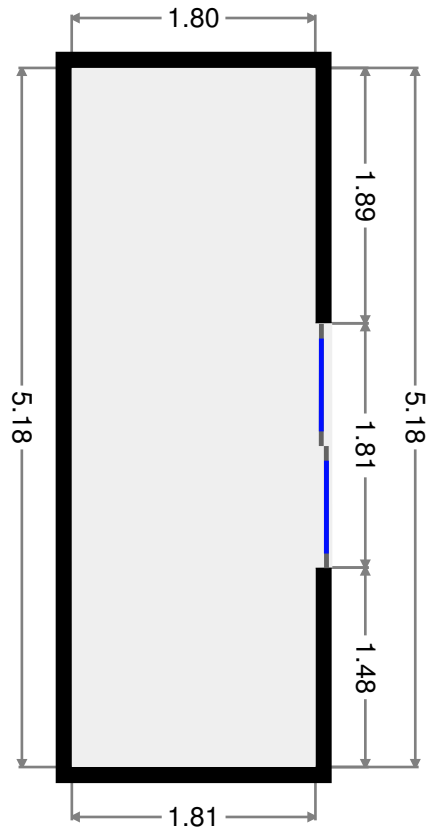
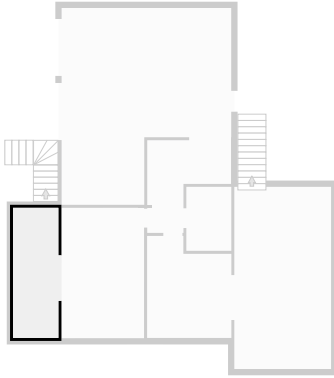

THIS FLOORPLAN IS PROVIDED WITHOUT WARRANTY OF ANY KIND. SENSOPIA DISCLAIMS ANY WARRANTY INCLUDING, WITHOUT LIMITATION, SATISFACTORY QUALITY OR ACCURACY OF DIMENSIONS.

1st Floor

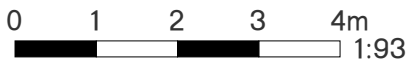
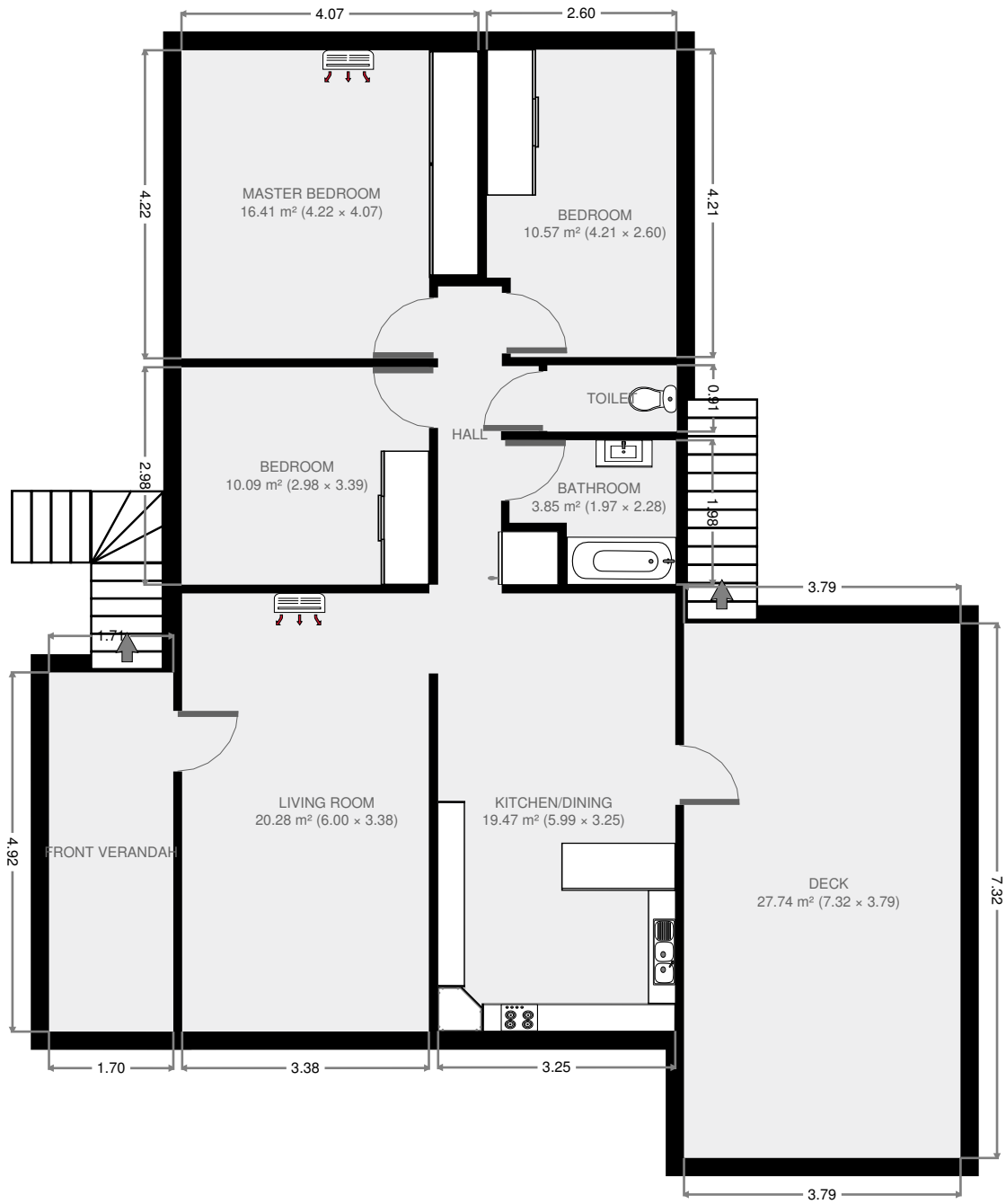

THIS FLOORPLAN IS PROVIDED WITHOUT WARRANTY OF ANY KIND. SENSOPIA DISCLAIMS ANY WARRANTY INCLUDING, WITHOUT LIMITATION, SATISFACTORY QUALITY OR ACCURACY OF DIMENSIONS.

184 German Street

Living Room

Width: 3.38 m
 Length: 6.00 m
 Area: 20.28 m²
 Perimeter: 18.76 m

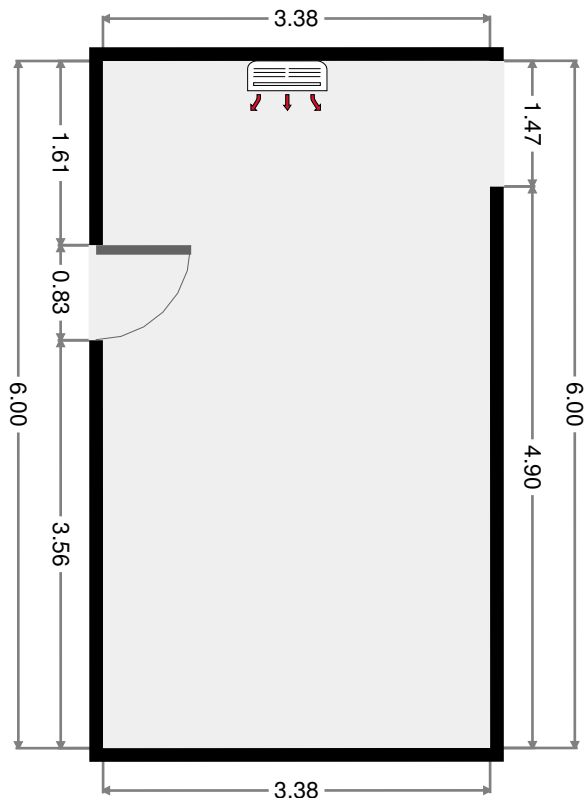
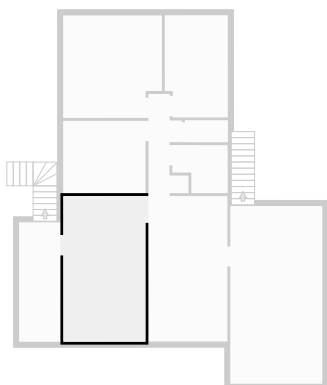

Kitchen/Dining

Width: 3.25 m
 Length: 5.99 m
 Area: 19.47 m²
 Perimeter: 18.48 m

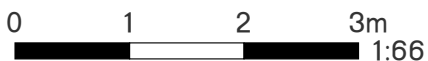
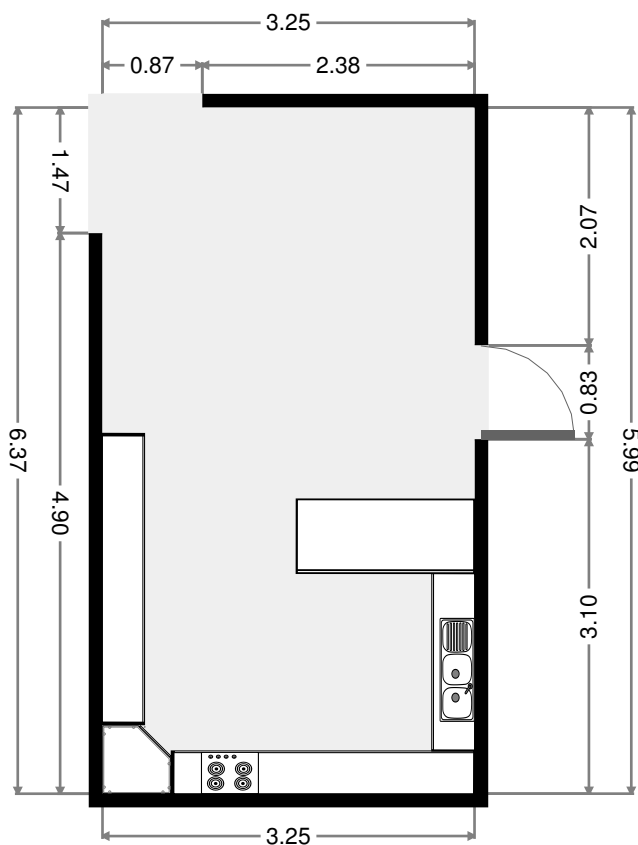
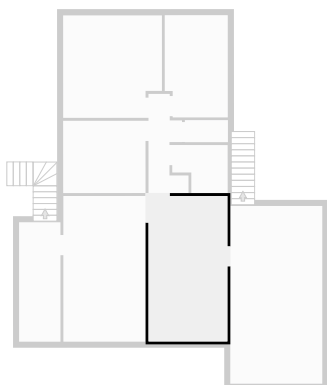

THIS FLOORPLAN IS PROVIDED WITHOUT WARRANTY OF ANY KIND. SENSOPIA DISCLAIMS ANY WARRANTY INCLUDING, WITHOUT LIMITATION, SATISFACTORY QUALITY OR ACCURACY OF DIMENSIONS.

Hall

Width: 1.65 m
 Length: 4.08 m
 Area: 4.56 m²
 Perimeter: 12.49 m

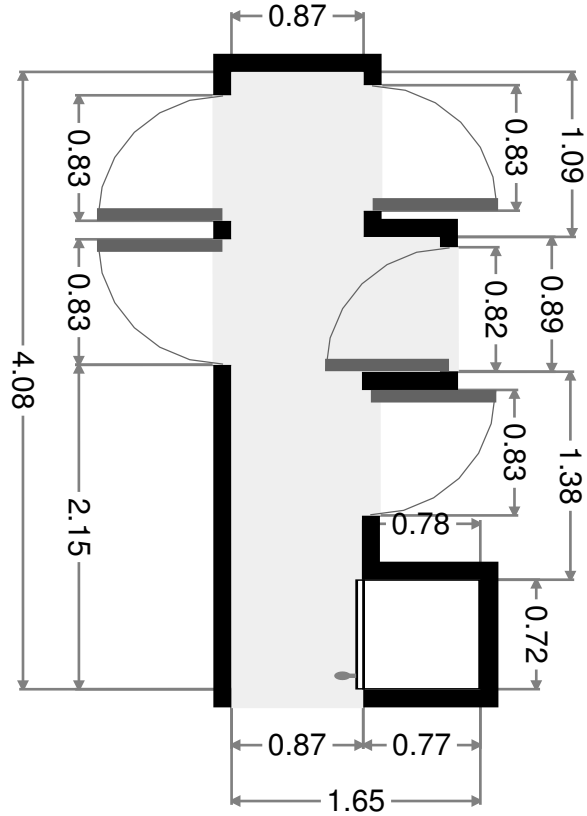
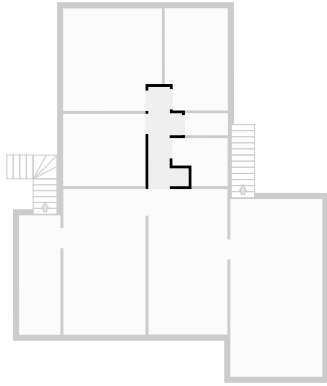

Bedroom

Width: 2.98 m
 Length: 3.39 m
 Area: 10.09 m²
 Perimeter: 12.74 m

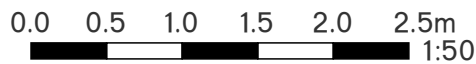
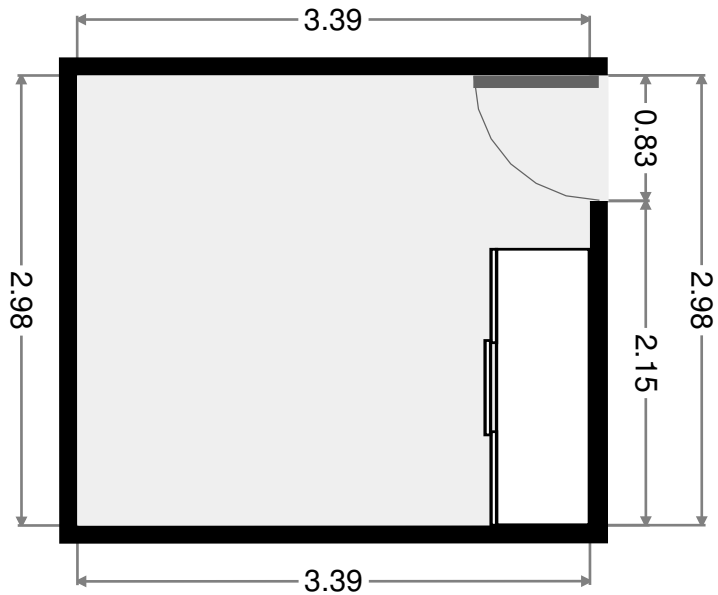
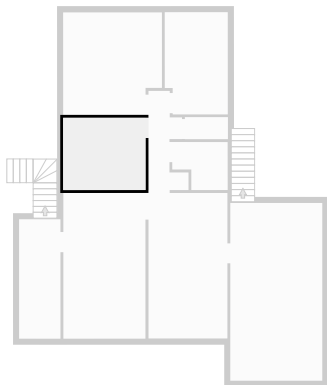

THIS FLOORPLAN IS PROVIDED WITHOUT WARRANTY OF ANY KIND. SENSOPIA DISCLAIMS ANY WARRANTY INCLUDING, WITHOUT LIMITATION, SATISFACTORY QUALITY OR ACCURACY OF DIMENSIONS.

Master Bedroom

Width: 4.07 m
 Length: 4.22 m
 Area: 16.41 m²
 Perimeter: 16.57 m

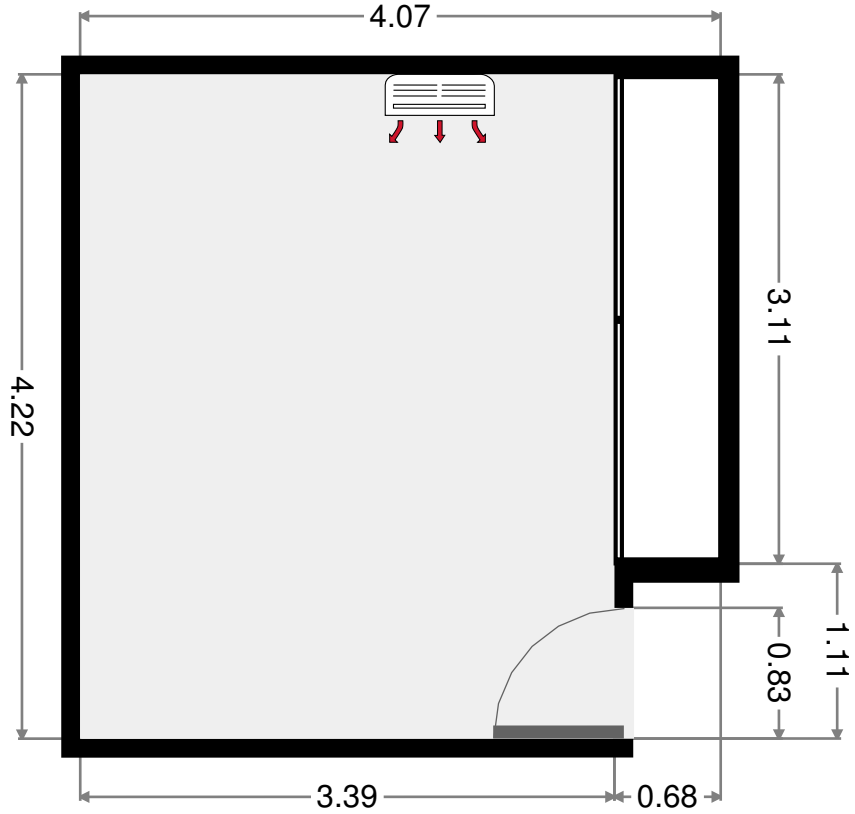
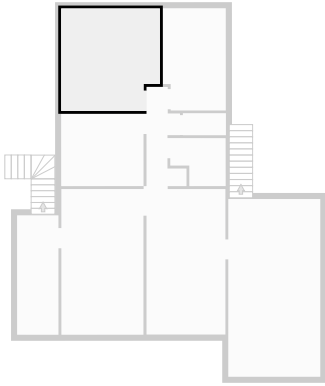

Bedroom

Width: 2.60 m
 Length: 4.21 m
 Area: 10.57 m²
 Perimeter: 13.61 m

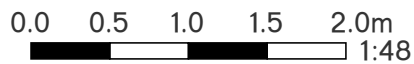
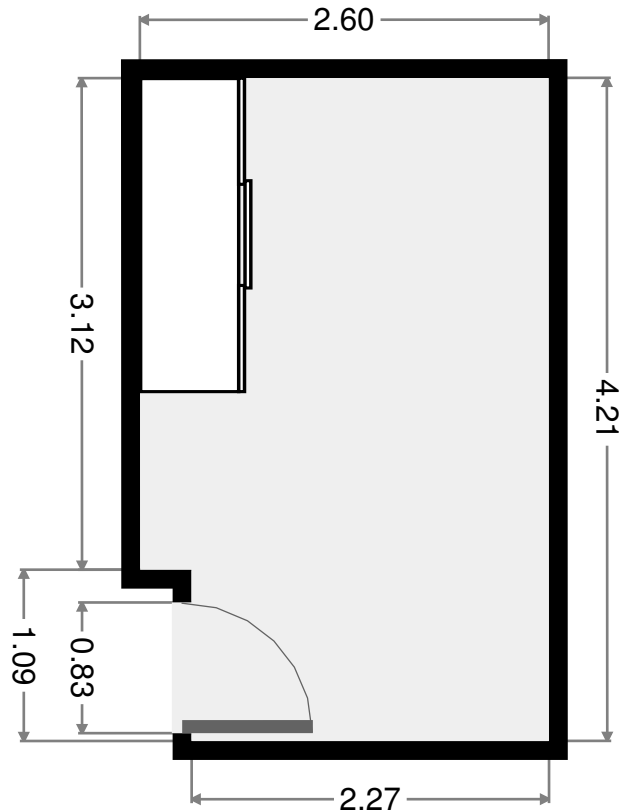
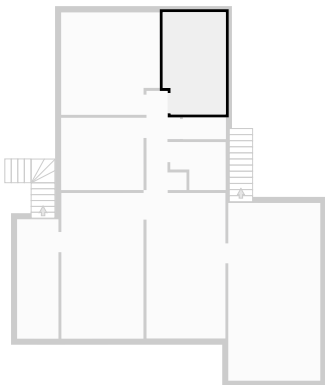

THIS FLOORPLAN IS PROVIDED WITHOUT WARRANTY OF ANY KIND. SENSOPIA DISCLAIMS ANY WARRANTY INCLUDING, WITHOUT LIMITATION, SATISFACTORY QUALITY OR ACCURACY OF DIMENSIONS.

Toilet

Width: 0.91 m
 Length: 1.78 m
 Area: 1.61 m²
 Perimeter: 5.36 m

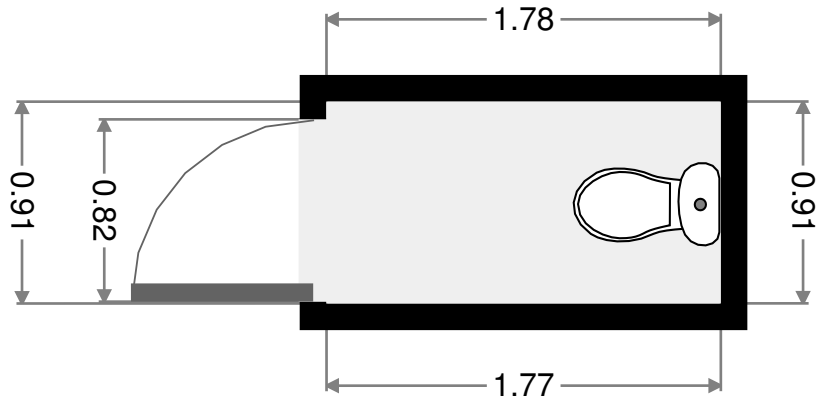
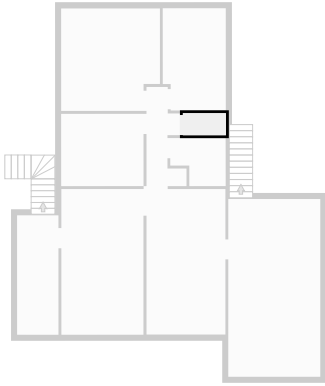

Bathroom

Width: 1.97 m
 Length: 2.28 m
 Area: 3.85 m²
 Perimeter: 8.52 m

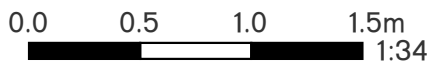
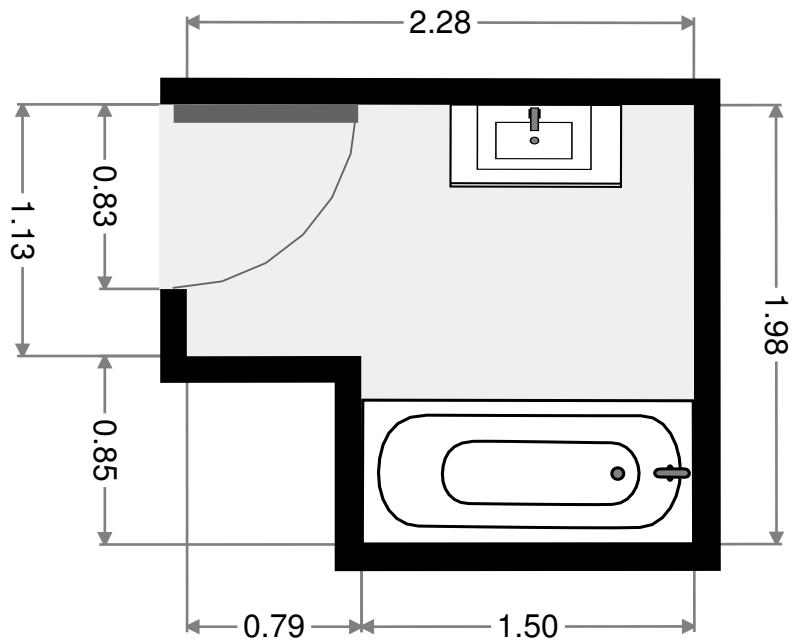
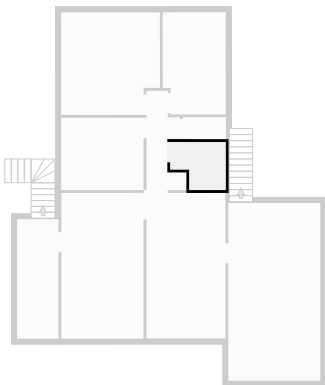

THIS FLOORPLAN IS PROVIDED WITHOUT WARRANTY OF ANY KIND. SENSOPIA DISCLAIMS ANY WARRANTY INCLUDING, WITHOUT LIMITATION, SATISFACTORY QUALITY OR ACCURACY OF DIMENSIONS.

Front Verandah

Width: 1.71 m
 Length: 4.92 m
 Area: 8.38 m²
 Perimeter: 13.25 m

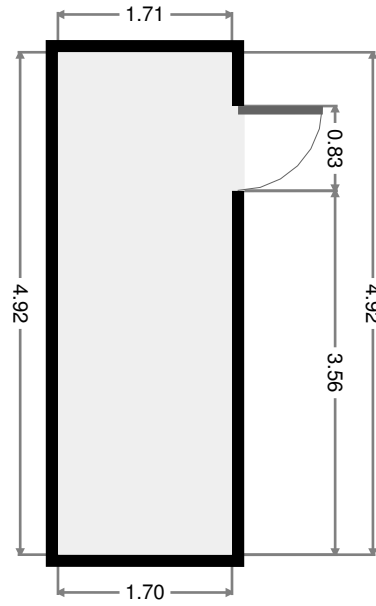
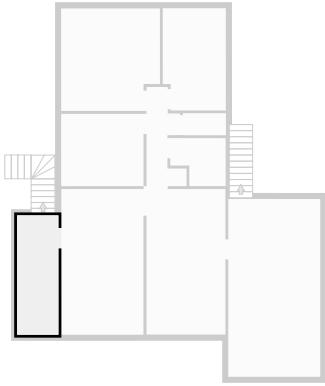

Deck

Width: 3.79 m
 Length: 7.32 m
 Area: 27.74 m²
 Perimeter: 22.22 m

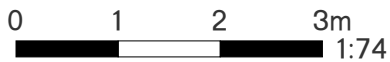
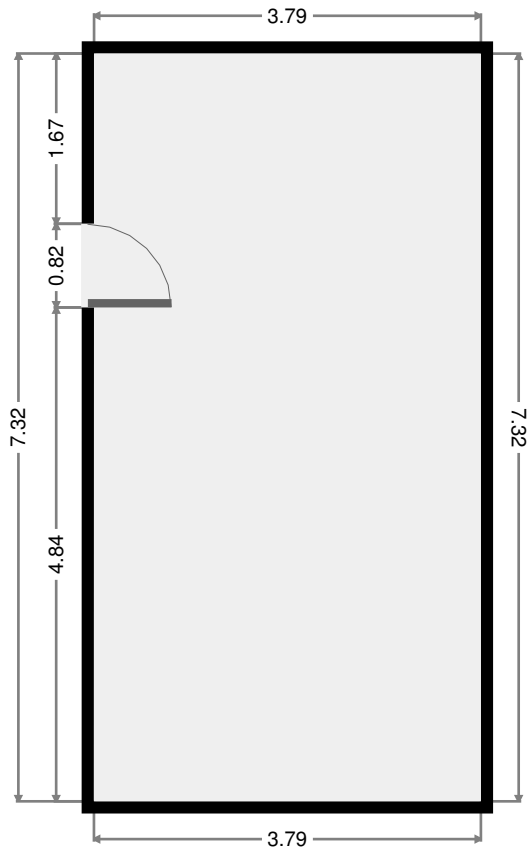
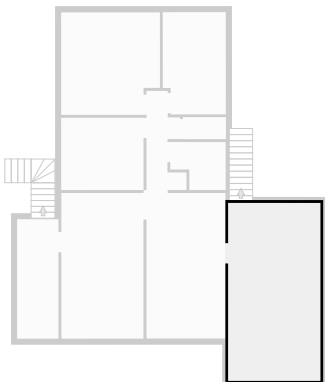

THIS FLOORPLAN IS PROVIDED WITHOUT WARRANTY OF ANY KIND. SENSOPIA DISCLAIMS ANY WARRANTY INCLUDING, WITHOUT LIMITATION, SATISFACTORY QUALITY OR ACCURACY OF DIMENSIONS.