

181 Stamford Street

Ground Floor

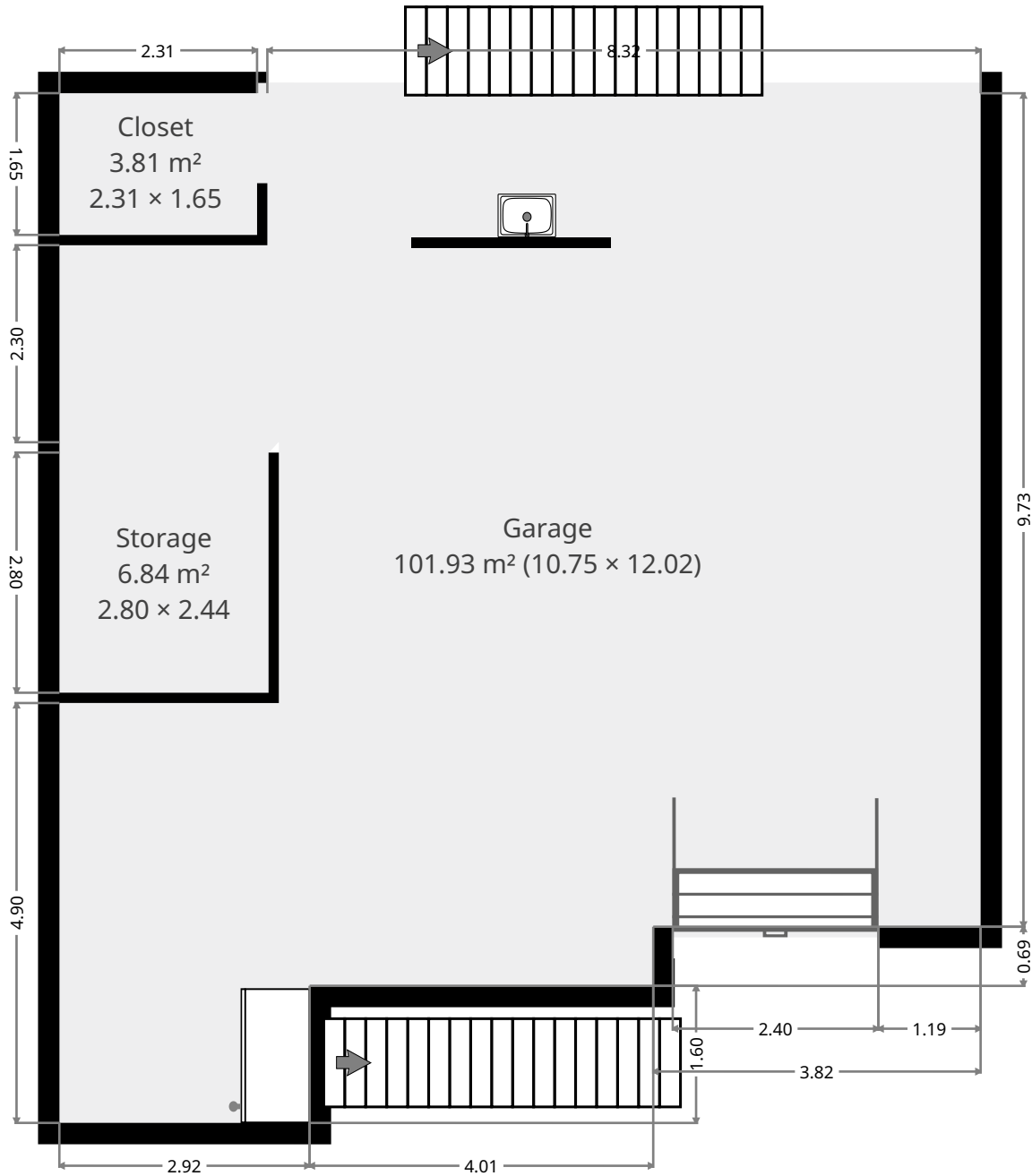

THIS FLOORPLAN IS PROVIDED WITHOUT WARRANTY OF ANY KIND. SENSOPIA DISCLAIMS ANY WARRANTY INCLUDING, WITHOUT LIMITATION, SATISFACTORY QUALITY OR ACCURACY OF DIMENSIONS.



181 Stamford Street

Garage

Width: 10.75 m
Length: 12.02 m
Area: 101.93 m²
Perimeter: 50.65 m

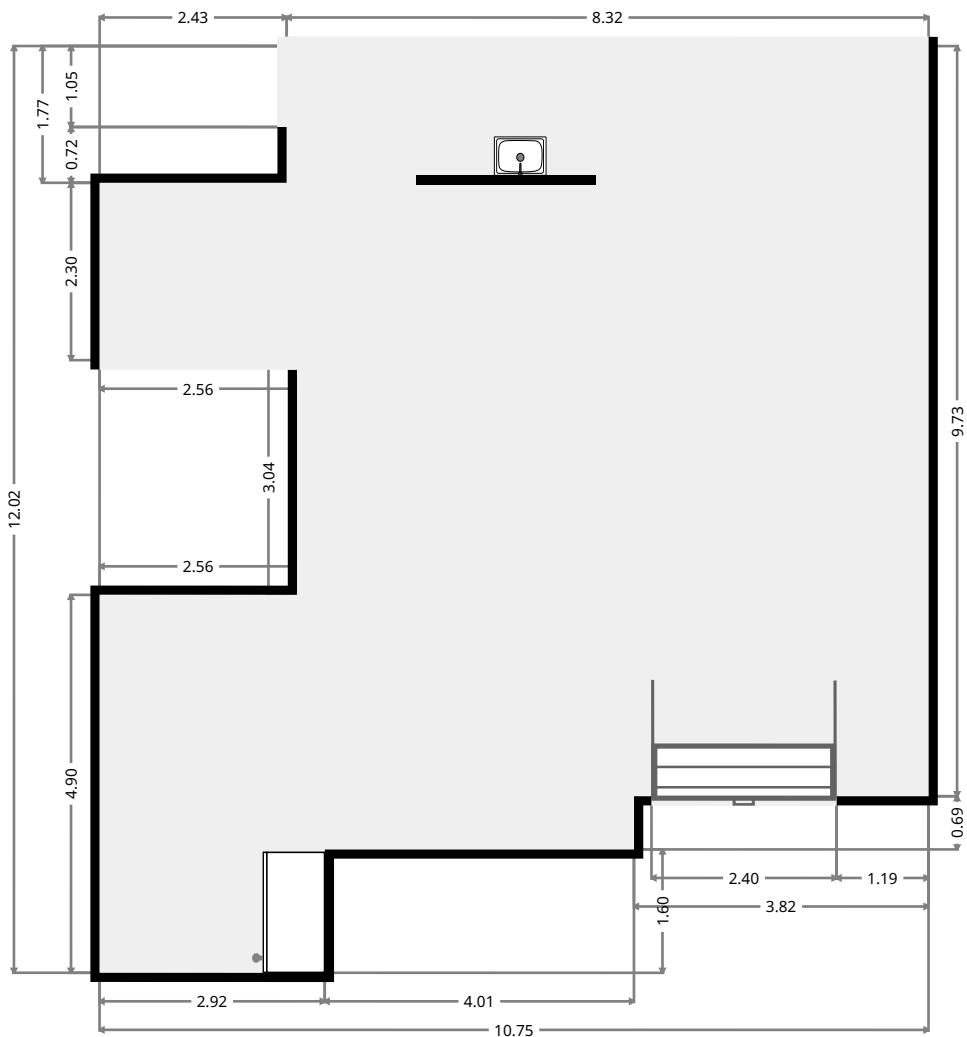
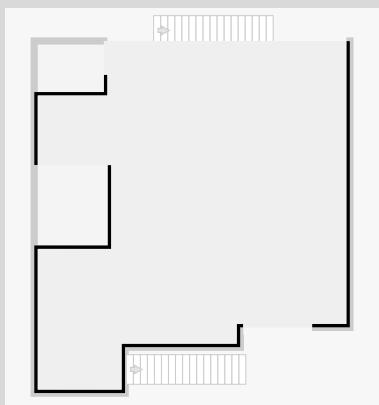

THIS FLOORPLAN IS PROVIDED WITHOUT WARRANTY OF ANY KIND. SENSOPIA DISCLAIMS ANY WARRANTY INCLUDING, WITHOUT LIMITATION, SATISFACTORY QUALITY OR ACCURACY OF DIMENSIONS.



181 Stamford Street

Storage

Width: 2.44 m
Length: 2.80 m
Area: 6.84 m²
Perimeter: 10.49 m

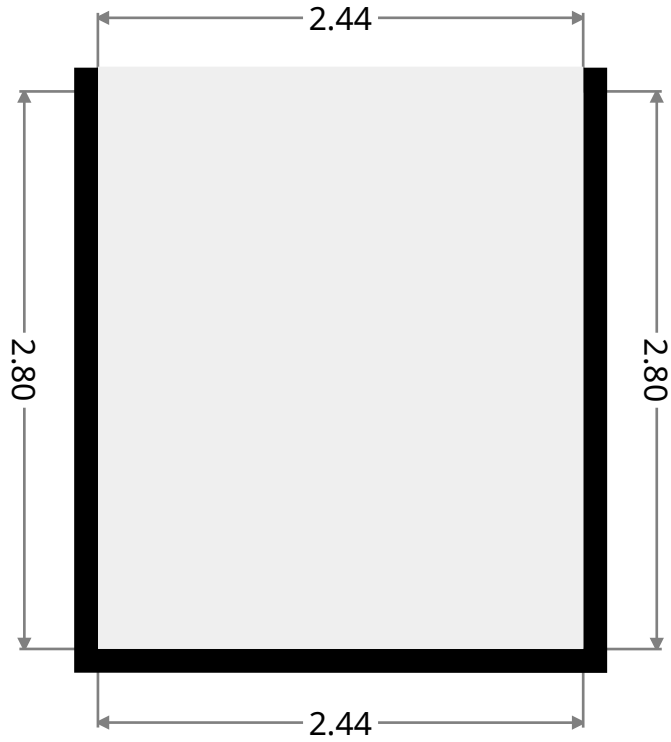
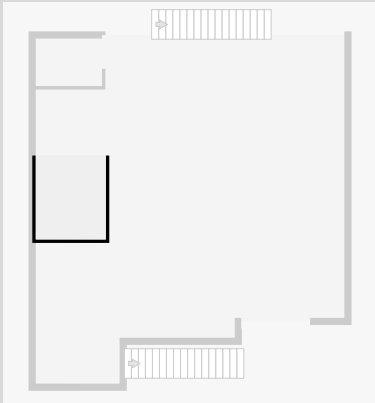

Closet

Width: 1.65 m
Length: 2.31 m
Area: 3.81 m²
Perimeter: 7.92 m

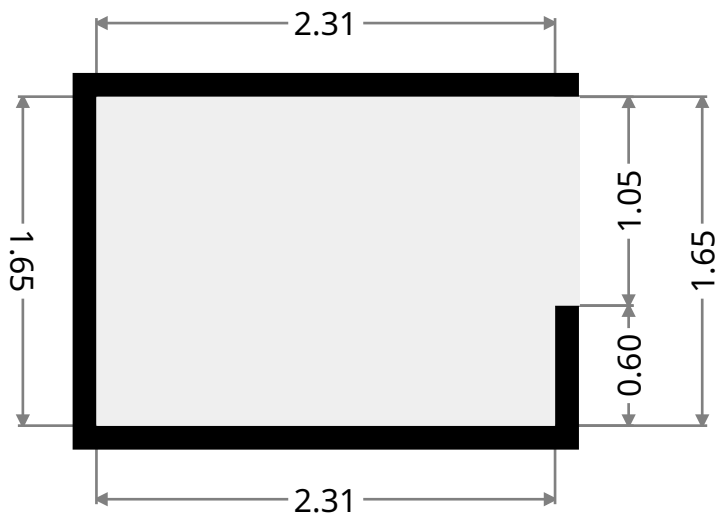
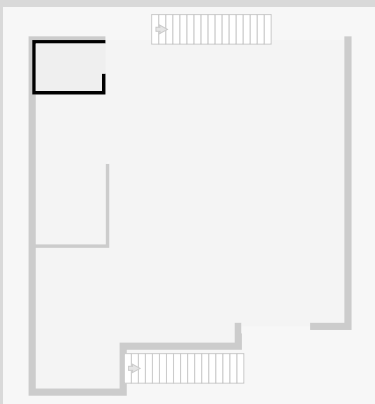

181 Stamford Street

1st Floor

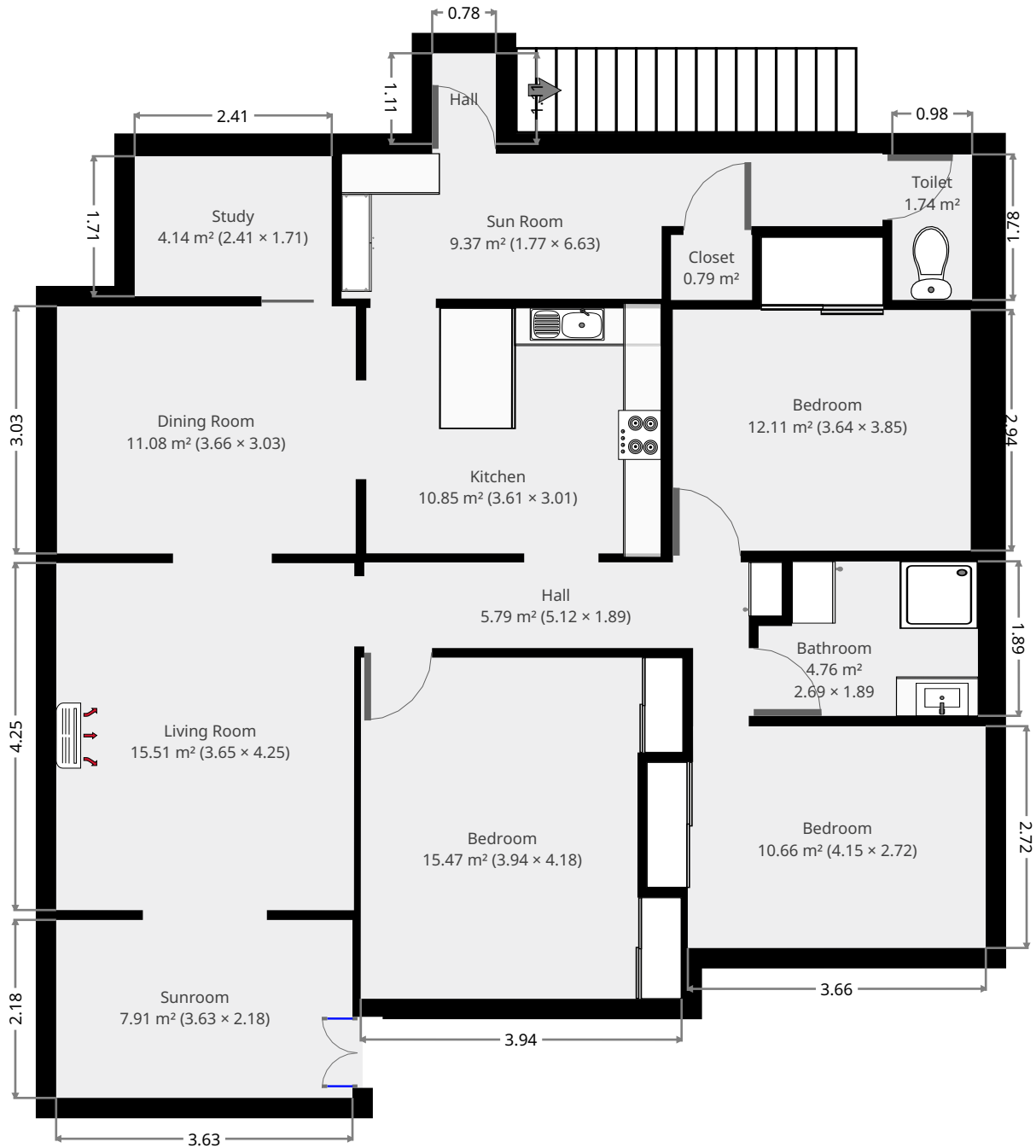

THIS FLOORPLAN IS PROVIDED WITHOUT WARRANTY OF ANY KIND. SENSOPIA DISCLAIMS ANY WARRANTY INCLUDING, WITHOUT LIMITATION, SATISFACTORY QUALITY OR ACCURACY OF DIMENSIONS.



181 Stamford Street

Sunroom

Width: 2.18 m
 Length: 3.63 m
 Area: 7.91 m²
 Perimeter: 11.62 m

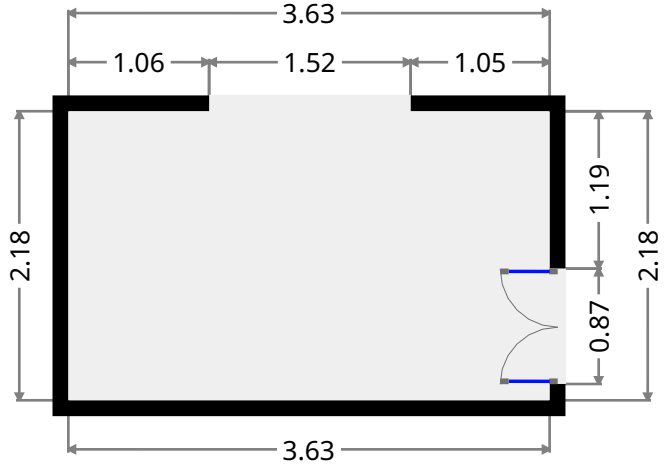
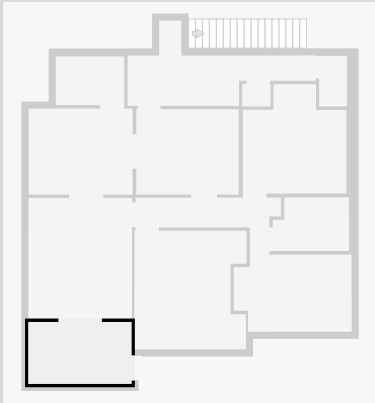

Living Room

Width: 3.65 m
 Length: 4.25 m
 Area: 15.51 m²
 Perimeter: 15.80 m

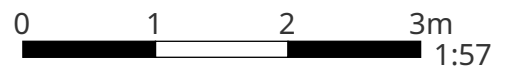
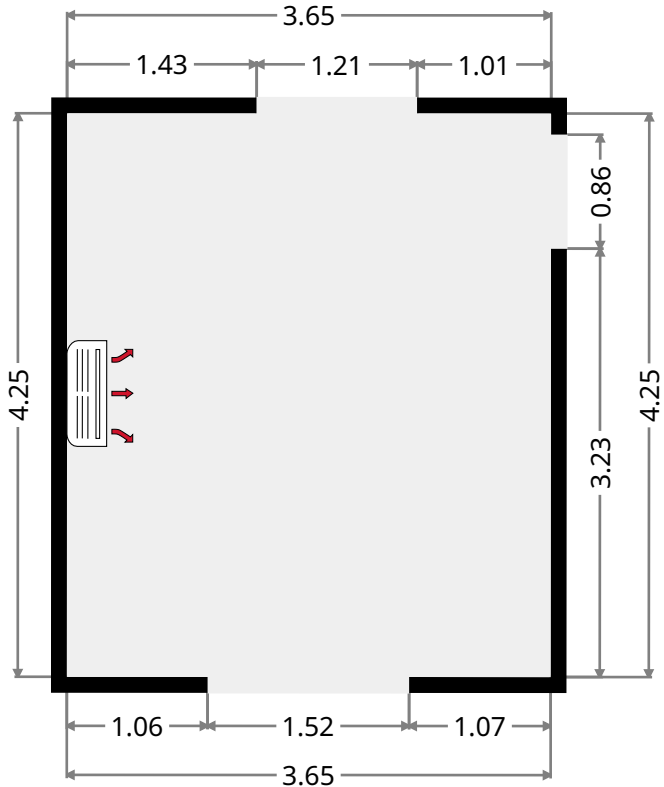
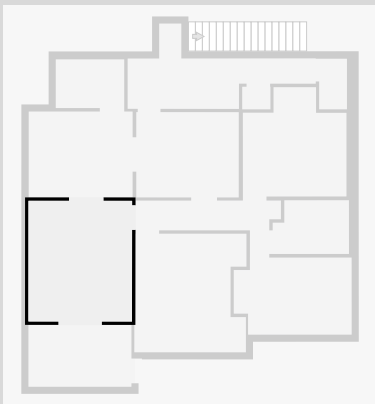

THIS FLOORPLAN IS PROVIDED WITHOUT WARRANTY OF ANY KIND. SENSOPIA DISCLAIMS ANY WARRANTY INCLUDING, WITHOUT LIMITATION, SATISFACTORY QUALITY OR ACCURACY OF DIMENSIONS.

181 Stamford Street

Hall

Width: 1.89 m
 Length: 5.12 m
 Area: 5.79 m²
 Perimeter: 14.02 m

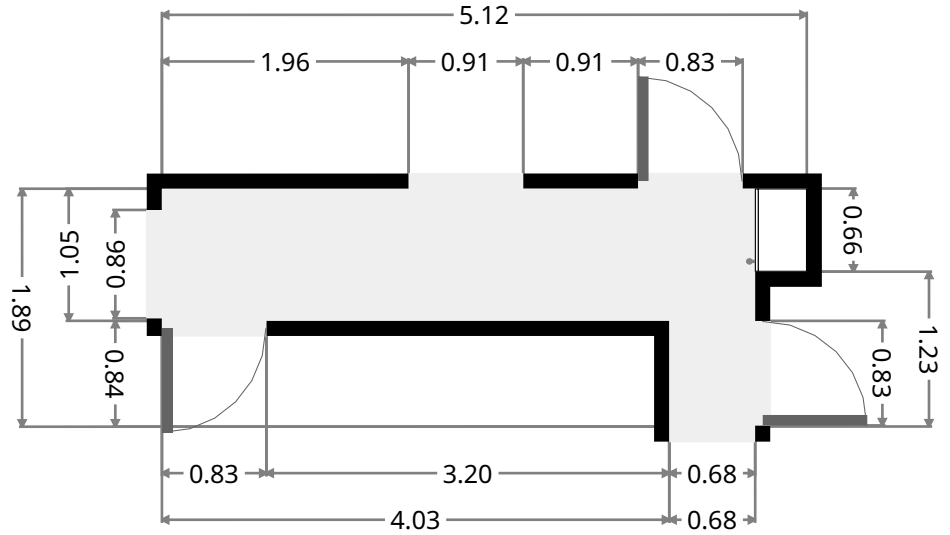
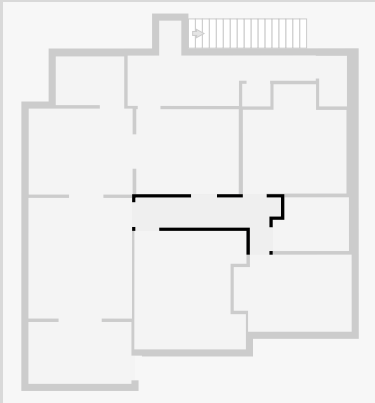

Bedroom

Width: 3.94 m
 Length: 4.18 m
 Area: 15.47 m²
 Perimeter: 17.33 m

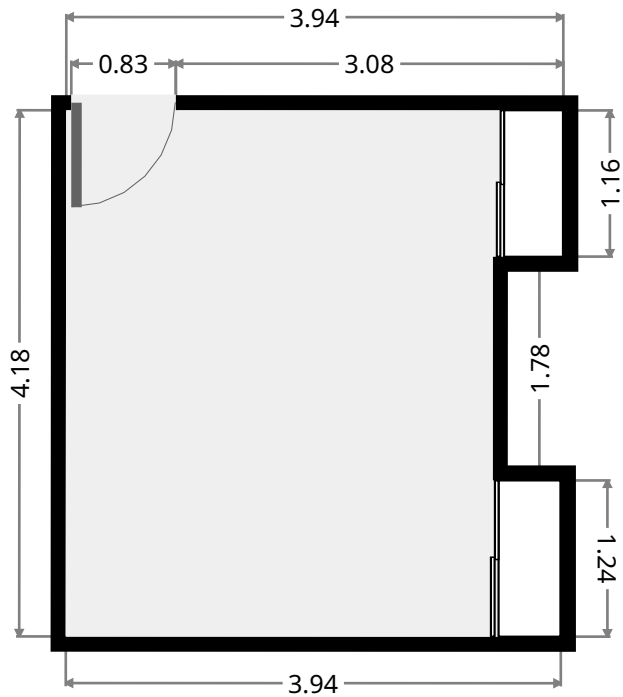
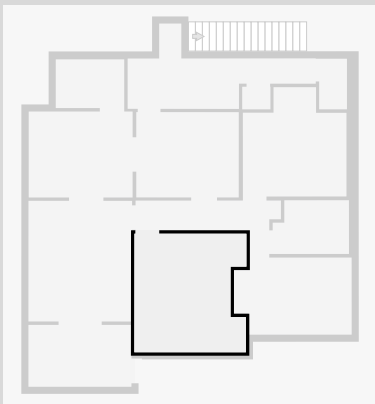

THIS FLOORPLAN IS PROVIDED WITHOUT WARRANTY OF ANY KIND. SENSOPIA DISCLAIMS ANY WARRANTY INCLUDING, WITHOUT LIMITATION, SATISFACTORY QUALITY OR ACCURACY OF DIMENSIONS.

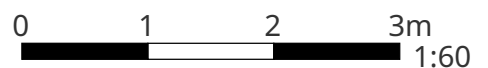

181 Stamford Street

Bedroom

Width: 2.72 m
Length: 4.15 m
Area: 10.66 m²
Perimeter: 13.74 m

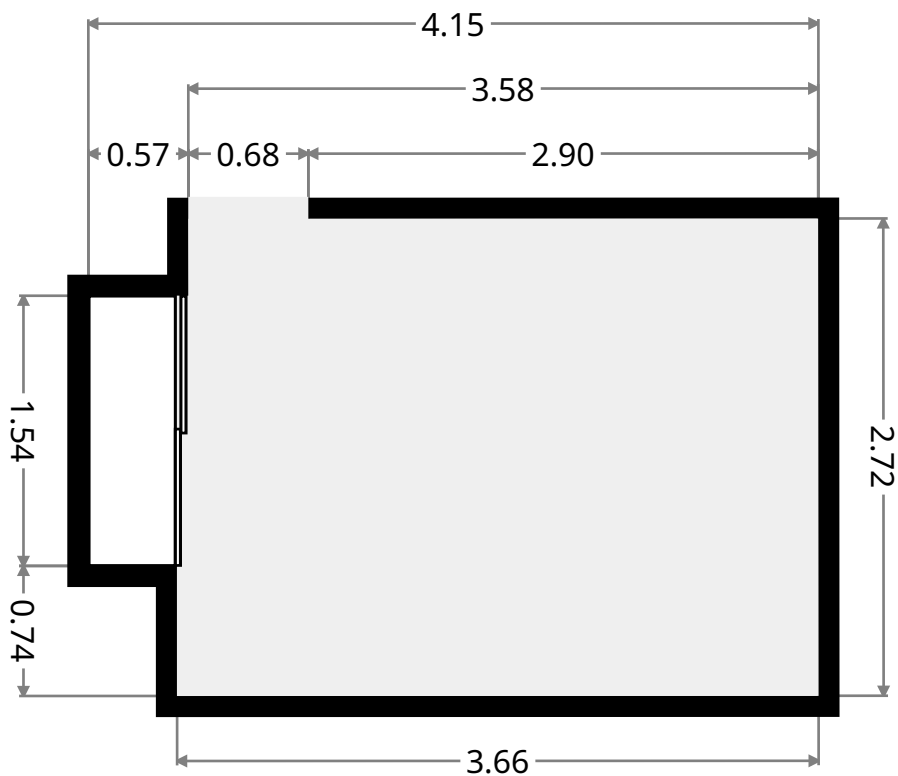
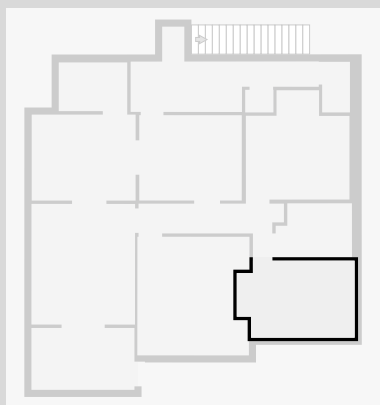

Bathroom

Width: 1.89 m
Length: 2.69 m
Area: 4.76 m²
Perimeter: 9.16 m

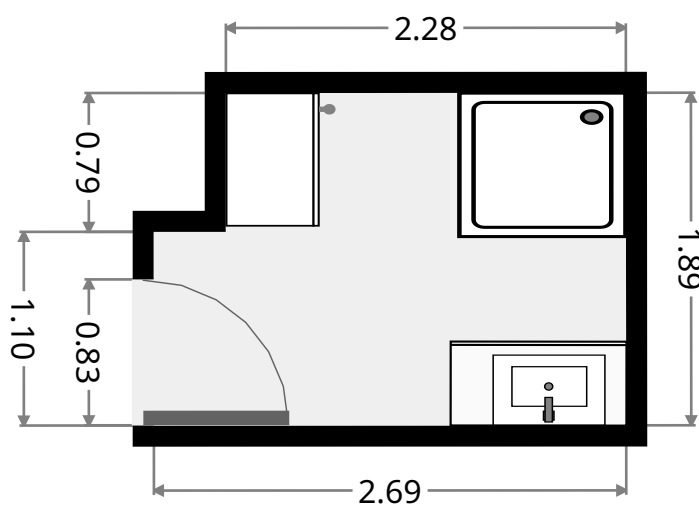
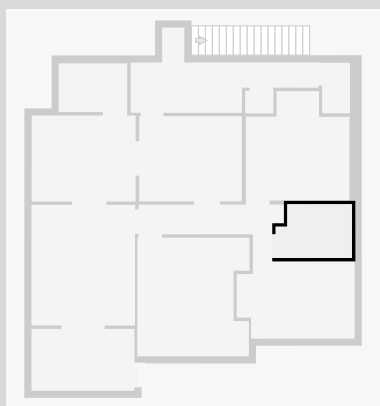

181 Stamford Street

Bedroom

Width: 3.64 m
 Length: 3.85 m
 Area: 12.11 m²
 Perimeter: 15.00 m

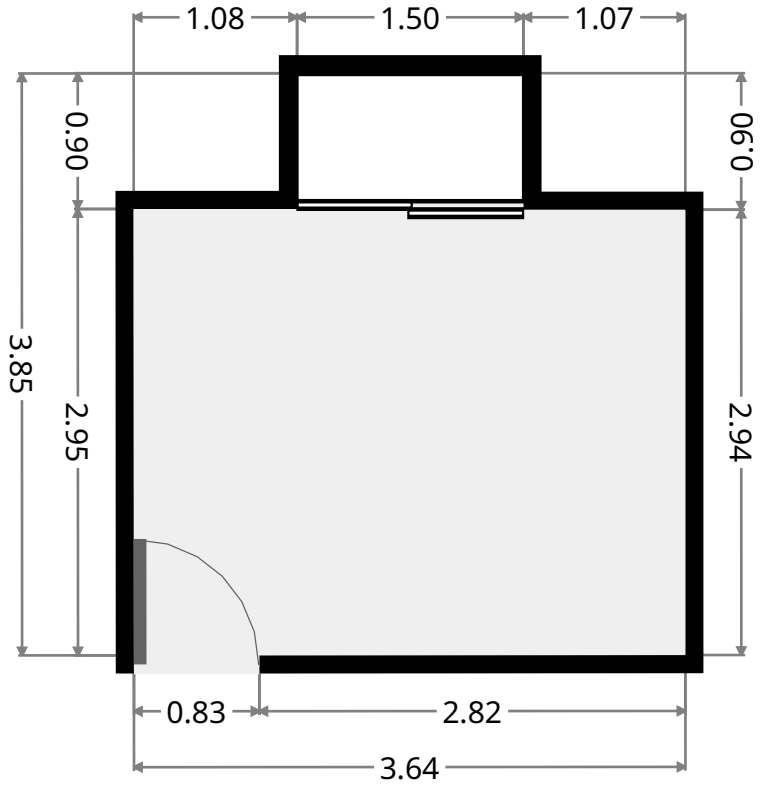
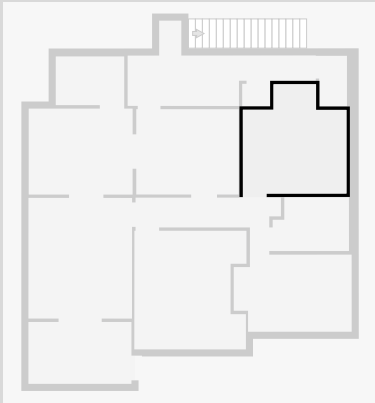

Kitchen

Width: 3.01 m
 Length: 3.61 m
 Area: 10.85 m²
 Perimeter: 13.23 m

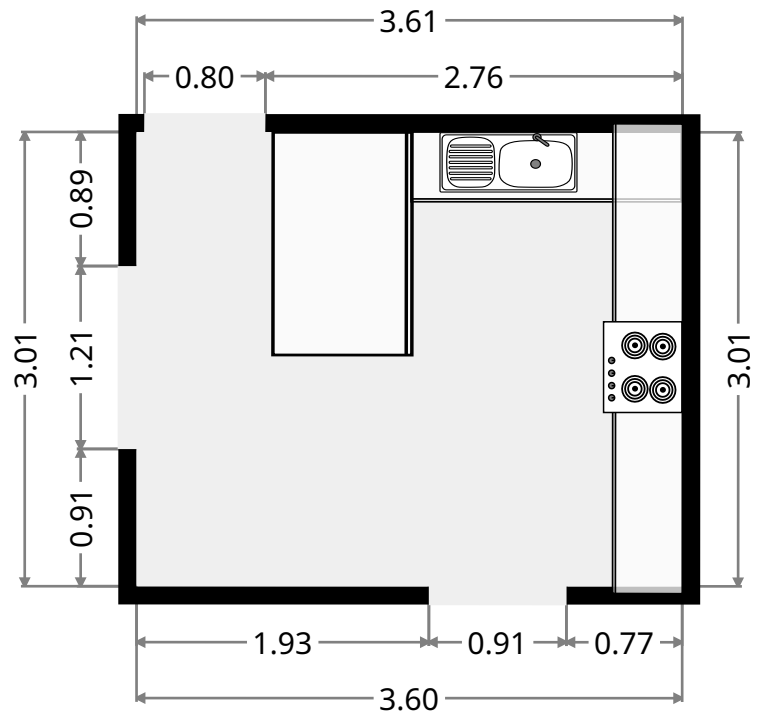
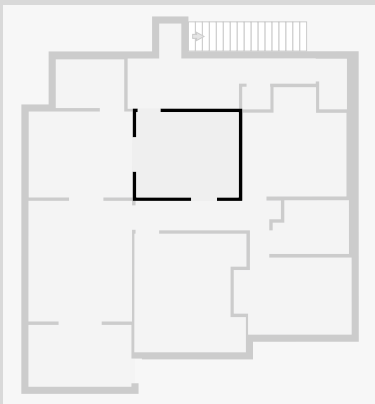

THIS FLOORPLAN IS PROVIDED WITHOUT WARRANTY OF ANY KIND. SENSOPIA DISCLAIMS ANY WARRANTY INCLUDING, WITHOUT LIMITATION, SATISFACTORY QUALITY OR ACCURACY OF DIMENSIONS.

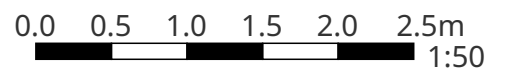

181 Stamford Street

Dining Room

Width: 3.03 m
 Length: 3.66 m
 Area: 11.08 m²
 Perimeter: 13.37 m

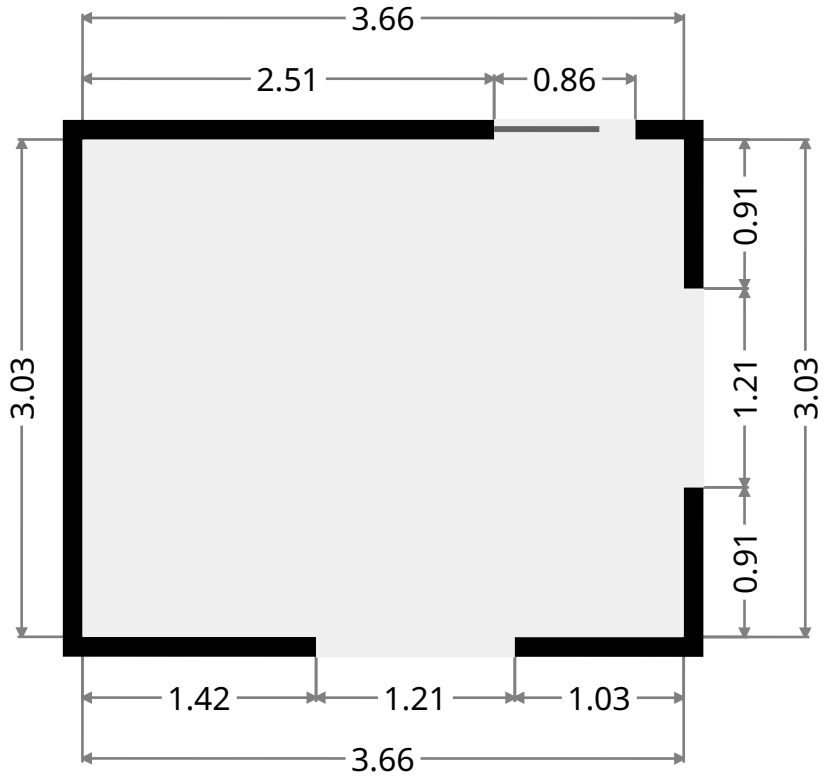
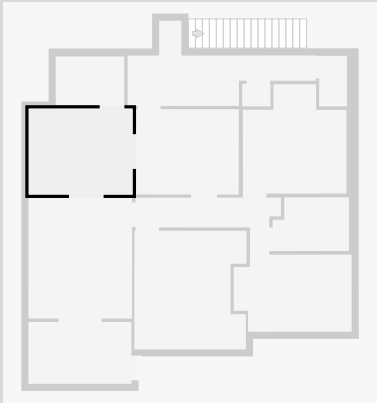

Study

Width: 1.71 m
 Length: 2.41 m
 Area: 4.14 m²
 Perimeter: 8.26 m

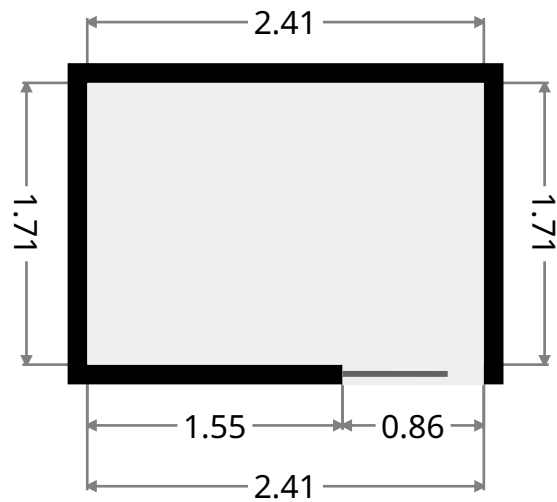
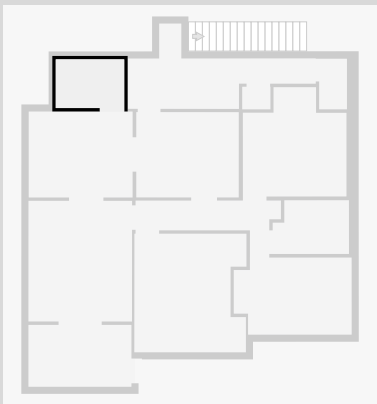

181 Stamford Street

Sun Room

Width: 1.77 m
Length: 6.63 m
Area: 9.37 m²
Perimeter: 16.81 m

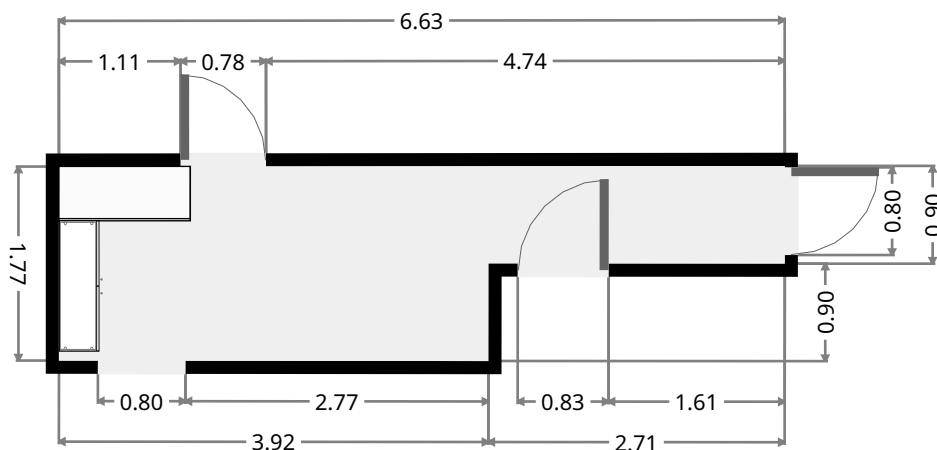
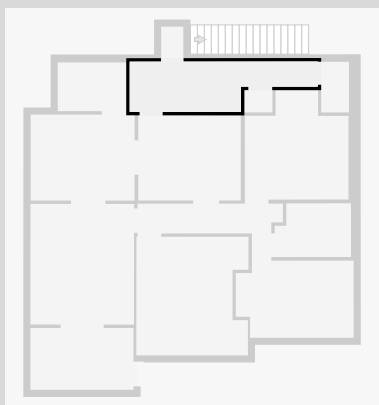

Closet

Width: 0.80 m
Length: 1.00 m
Area: 0.79 m²
Perimeter: 3.58 m

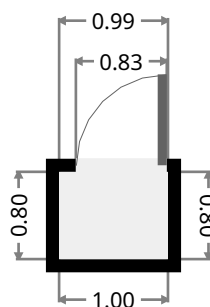
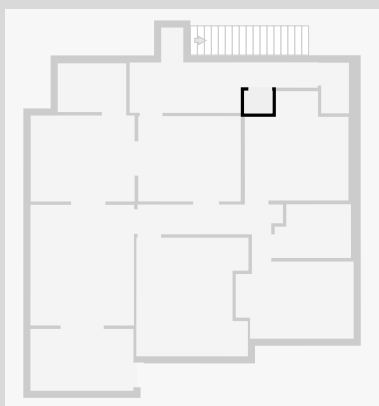

181 Stamford Street

Toilet

Width: 0.98 m
Length: 1.78 m
Area: 1.74 m²
Perimeter: 5.52 m

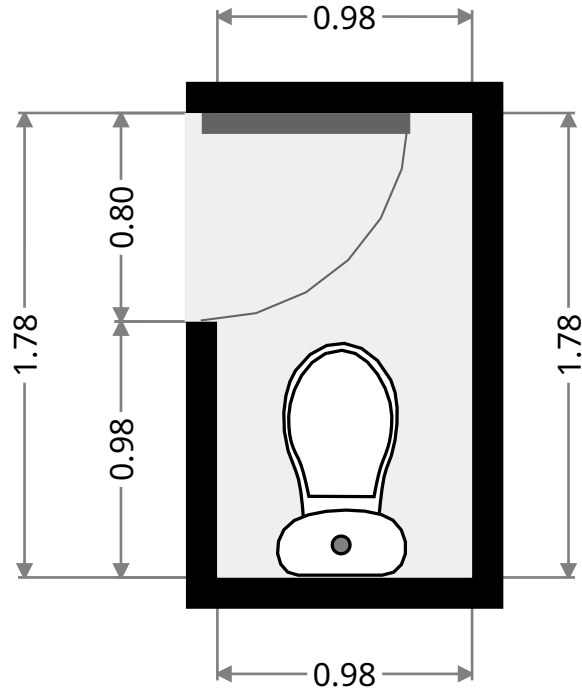
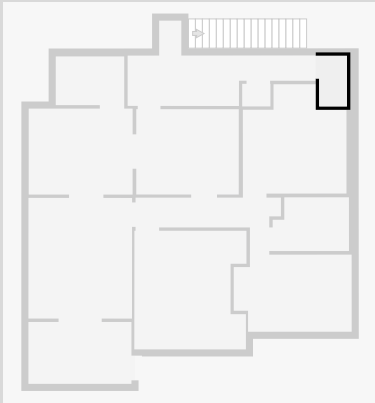

Hall

Width: 0.78 m
Length: 1.11 m
Area: 0.87 m²
Perimeter: 3.78 m

