

18 Wilmington Street

Ground Floor

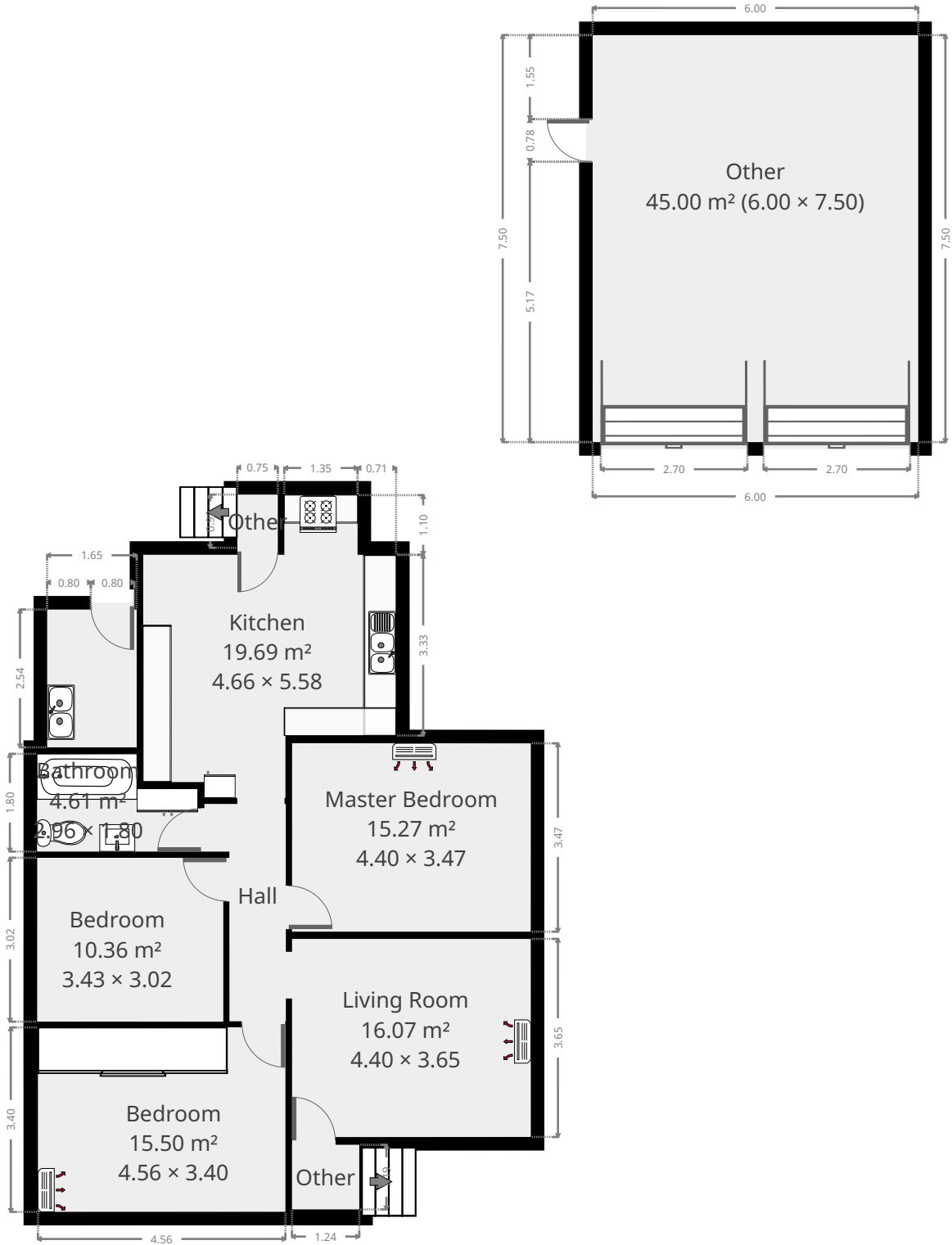

THIS FLOORPLAN IS PROVIDED WITHOUT WARRANTY OF ANY KIND. SENSOPIA DISCLAIMS ANY WARRANTY INCLUDING, WITHOUT LIMITATION, SATISFACTORY QUALITY OR ACCURACY OF DIMENSIONS.



18 Wilmington Street

Living Room

Width: 3.65 m
 Length: 4.40 m
 Area: 16.07 m²
 Perimeter: 16.10 m

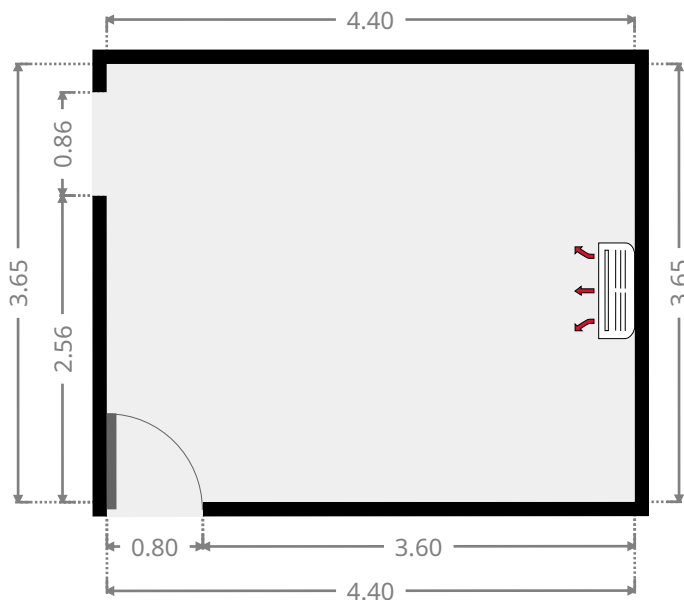
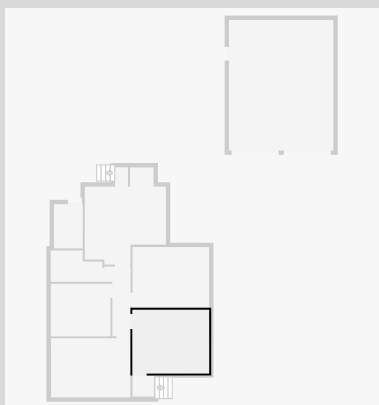

Hall

Width: 1.50 m
 Length: 4.01 m
 Area: 4.57 m²
 Perimeter: 11.01 m

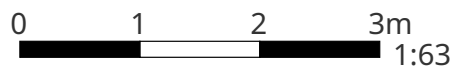
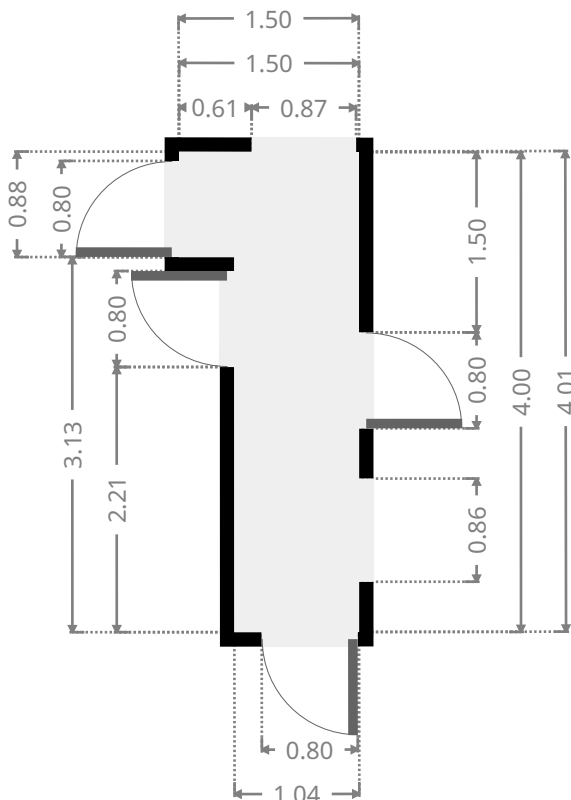
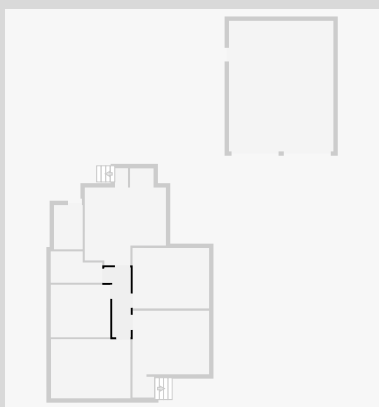

THIS FLOORPLAN IS PROVIDED WITHOUT WARRANTY OF ANY KIND. SENSOPIA DISCLAIMS ANY WARRANTY INCLUDING, WITHOUT LIMITATION, SATISFACTORY QUALITY OR ACCURACY OF DIMENSIONS.

18 Wilmington Street

Bedroom

Width: 3.40 m
 Length: 4.56 m
 Area: 15.50 m²
 Perimeter: 15.92 m

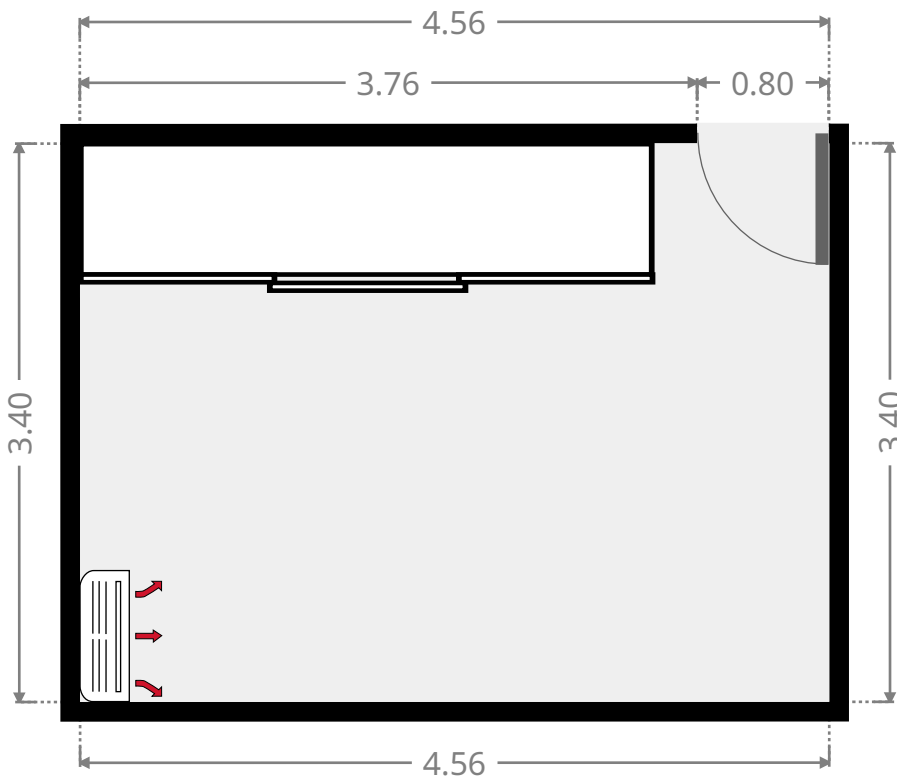
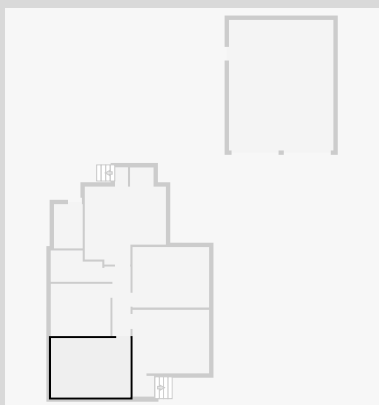

Bedroom

Width: 3.02 m
 Length: 3.43 m
 Area: 10.36 m²
 Perimeter: 12.90 m

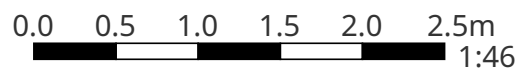
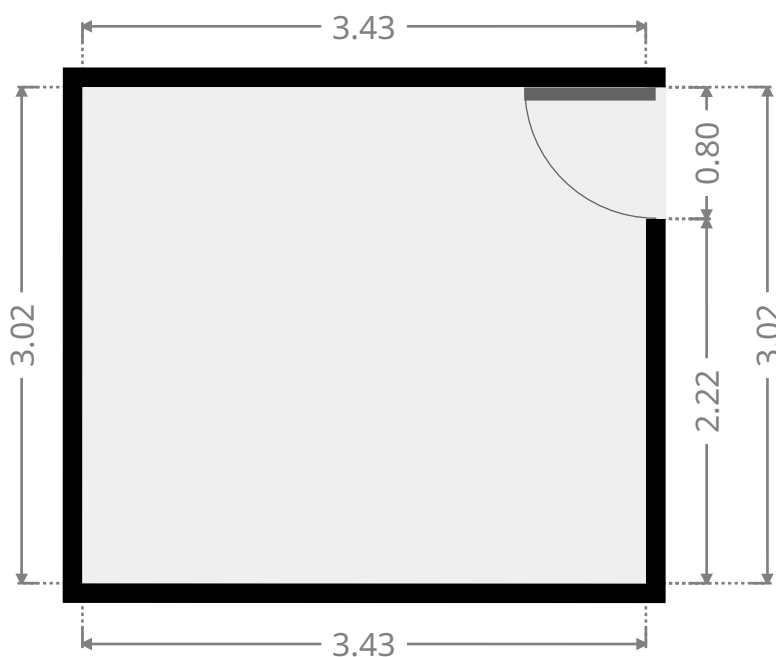
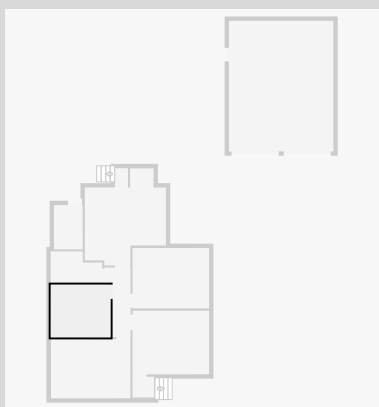

THIS FLOORPLAN IS PROVIDED WITHOUT WARRANTY OF ANY KIND. SENSOPIA DISCLAIMS ANY WARRANTY INCLUDING, WITHOUT LIMITATION, SATISFACTORY QUALITY OR ACCURACY OF DIMENSIONS.

18 Wilmington Street

Master Bedroom

Width: 3.47 m
 Length: 4.40 m
 Area: 15.27 m²
 Perimeter: 15.74 m

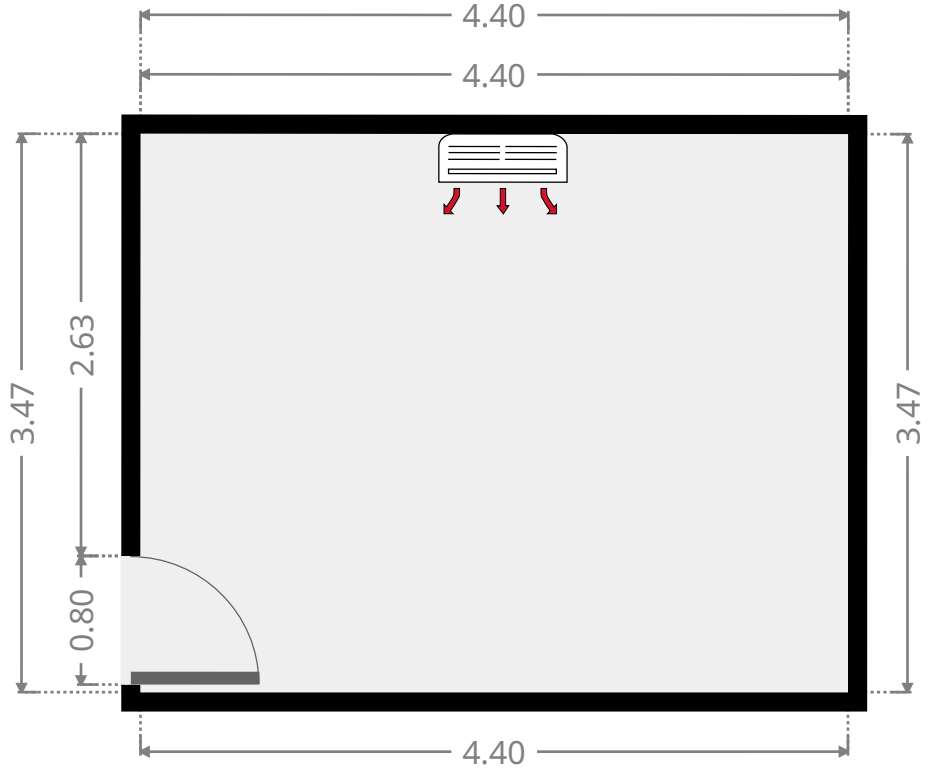
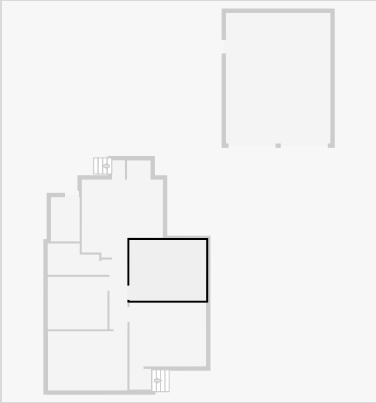

Bathroom

Width: 1.80 m
 Length: 2.96 m
 Area: 4.61 m²
 Perimeter: 9.53 m

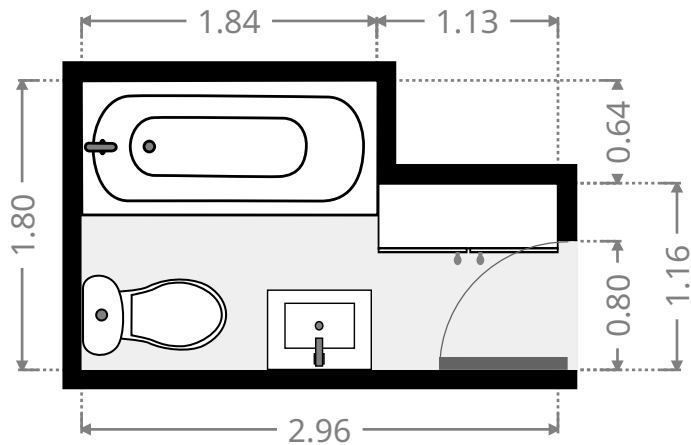
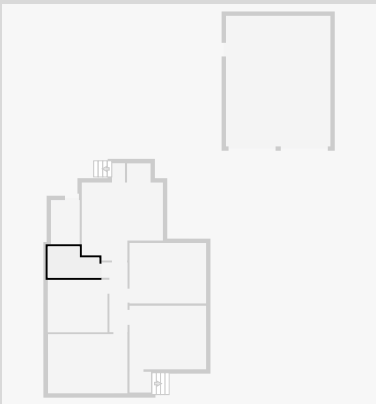

THIS FLOORPLAN IS PROVIDED WITHOUT WARRANTY OF ANY KIND. SENSOPIA DISCLAIMS ANY WARRANTY INCLUDING, WITHOUT LIMITATION, SATISFACTORY QUALITY OR ACCURACY OF DIMENSIONS.

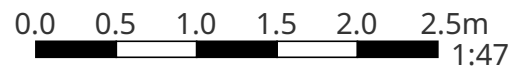

18 Wilmington Street

Kitchen

Width: 4.66 m
 Length: 5.58 m
 Area: 19.69 m²
 Perimeter: 20.48 m

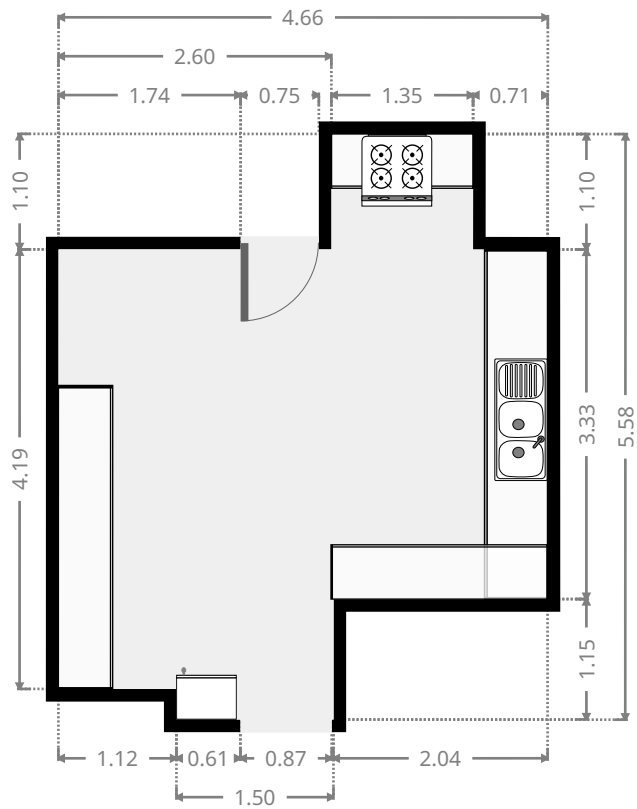
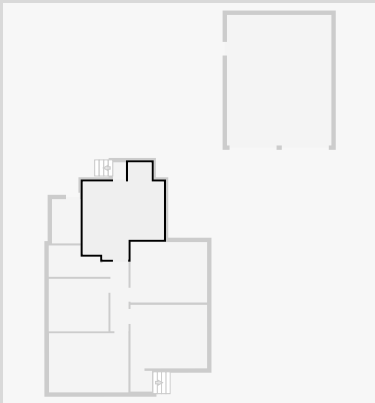

Other

Width: 0.75 m
 Length: 0.98 m
 Area: 0.73 m²
 Perimeter: 3.45 m

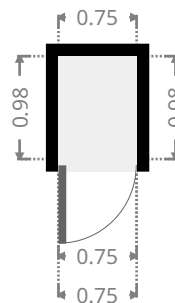
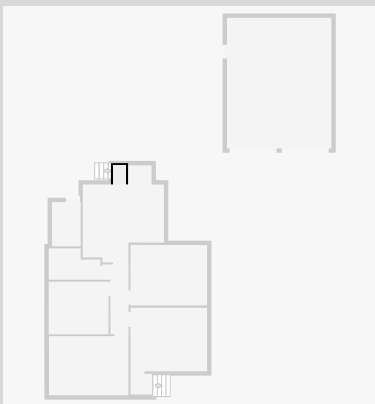

THIS FLOORPLAN IS PROVIDED WITHOUT WARRANTY OF ANY KIND. SENSOPIA DISCLAIMS ANY WARRANTY INCLUDING, WITHOUT LIMITATION, SATISFACTORY QUALITY OR ACCURACY OF DIMENSIONS.

18 Wilmington Street

Other

Width: 1.19 m
 Length: 1.24 m
 Area: 1.48 m²
 Perimeter: 4.86 m

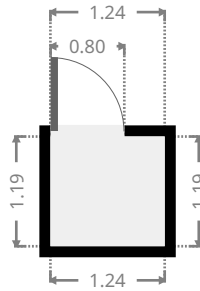
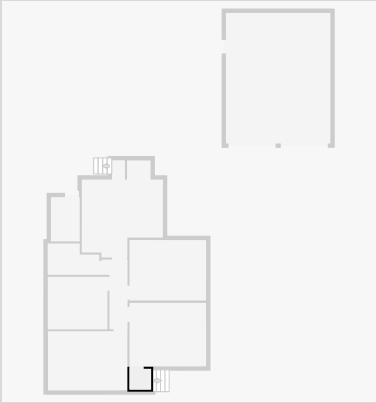

Other

Width: 6.00 m
 Length: 7.50 m
 Area: 45.00 m²
 Perimeter: 27.00 m

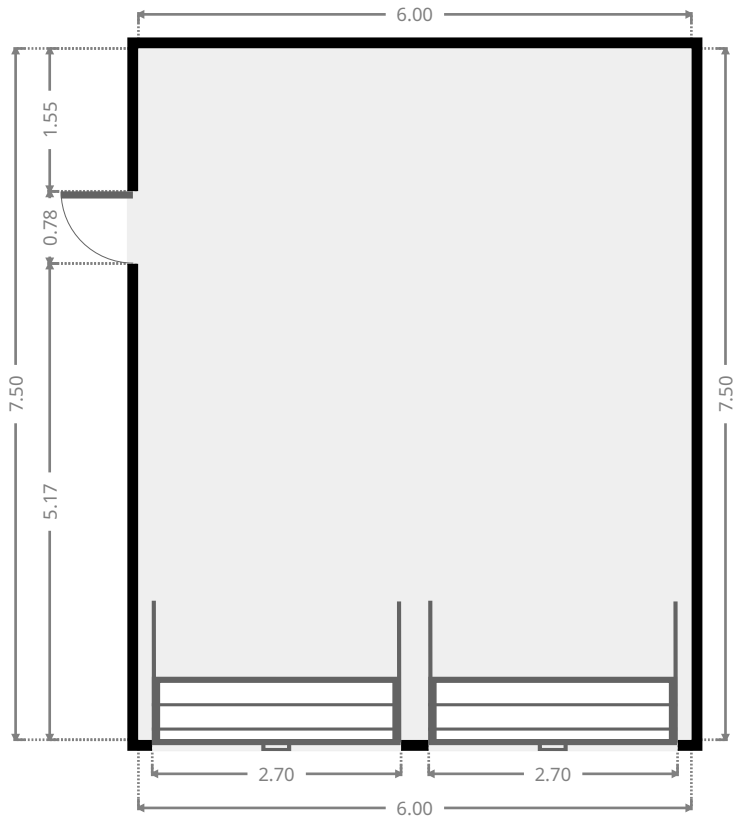
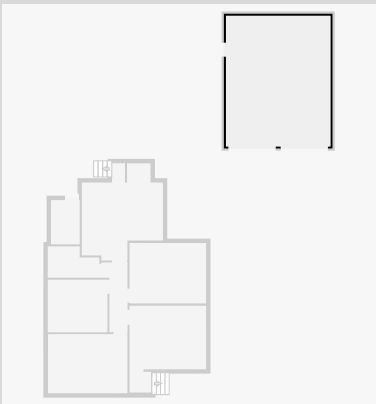

THIS FLOORPLAN IS PROVIDED WITHOUT WARRANTY OF ANY KIND. SENSOPIA DISCLAIMS ANY WARRANTY INCLUDING, WITHOUT LIMITATION, SATISFACTORY QUALITY OR ACCURACY OF DIMENSIONS.

18 Wilmington Street

Laundry Room

Width: 1.65 m
Length: 2.54 m
Area: 4.19 m²
Perimeter: 8.38 m

