

18 Weinholt Street

Ground Floor

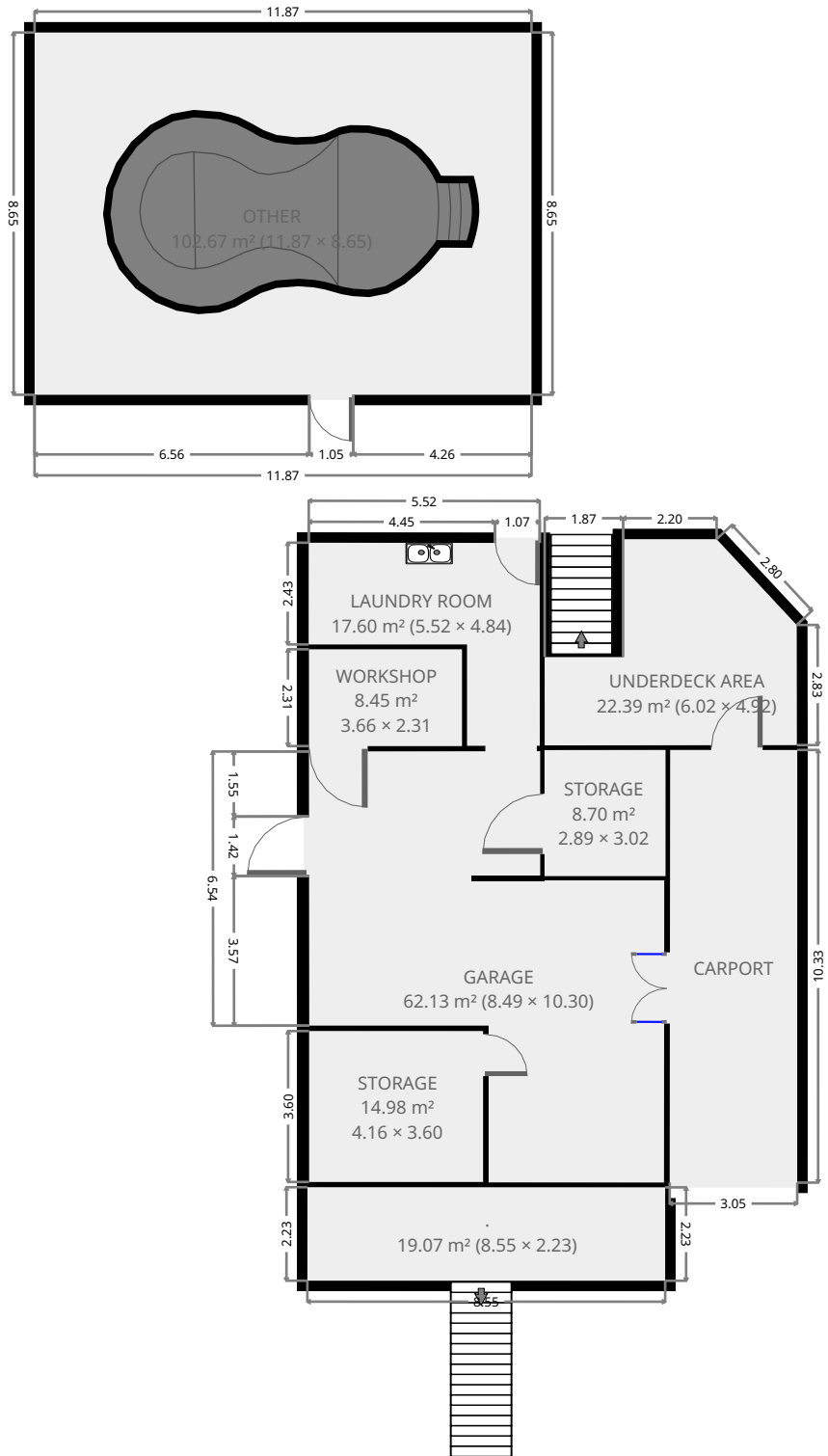

THIS FLOORPLAN IS PROVIDED WITHOUT WARRANTY OF ANY KIND. SENSOPIA DISCLAIMS ANY WARRANTY INCLUDING, WITHOUT LIMITATION, SATISFACTORY QUALITY OR ACCURACY OF DIMENSIONS.



18 Weinholt Street

Garage

Width: 8.49 m
Length: 10.30 m
Area: 62.13 m²
Perimeter: 37.55 m

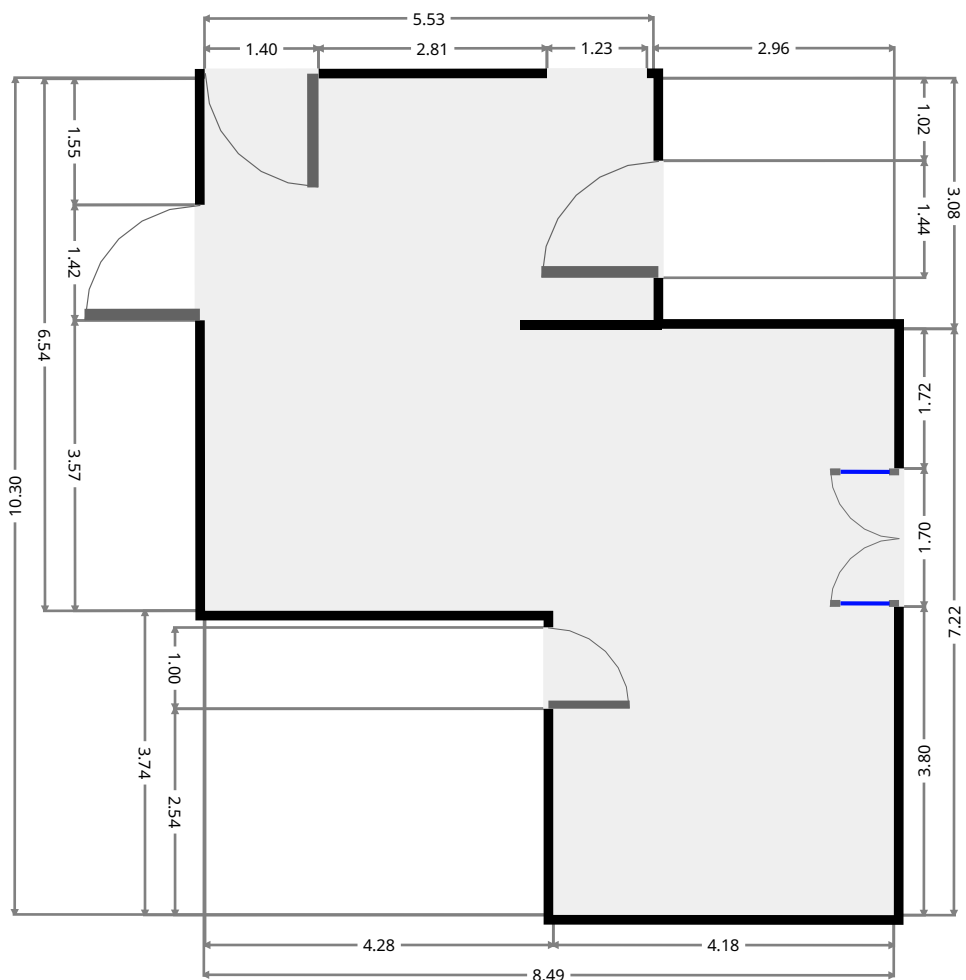
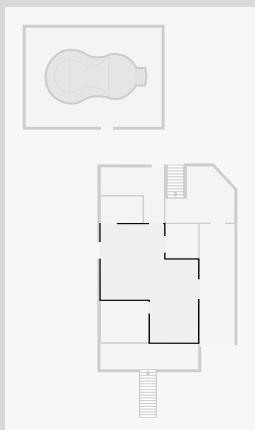

THIS FLOORPLAN IS PROVIDED WITHOUT WARRANTY OF ANY KIND. SENSOPIA DISCLAIMS ANY WARRANTY INCLUDING, WITHOUT LIMITATION, SATISFACTORY QUALITY OR ACCURACY OF DIMENSIONS.



18 Weinholt Street

Workshop

Width: 2.31 m
 Length: 3.66 m
 Area: 8.45 m²
 Perimeter: 11.93 m

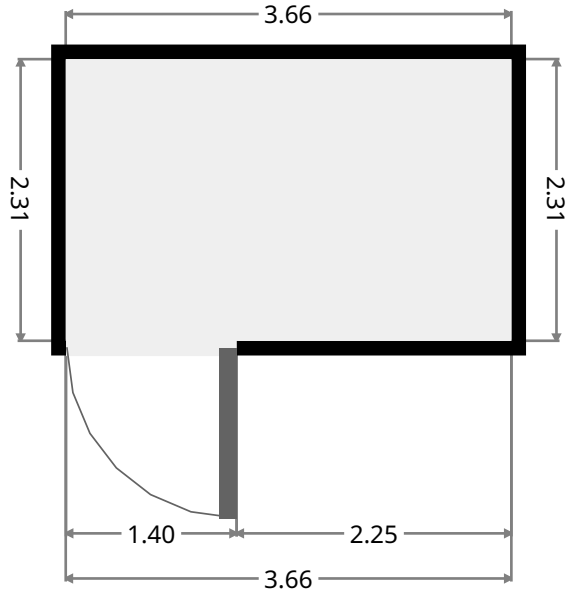
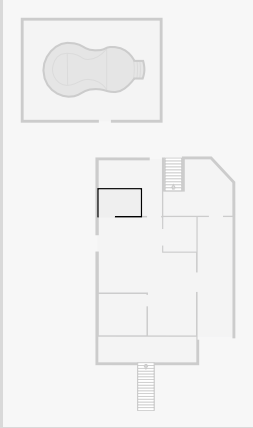

Laundry Room

Width: 4.84 m
 Length: 5.52 m
 Area: 17.60 m²
 Perimeter: 20.73 m

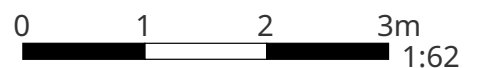
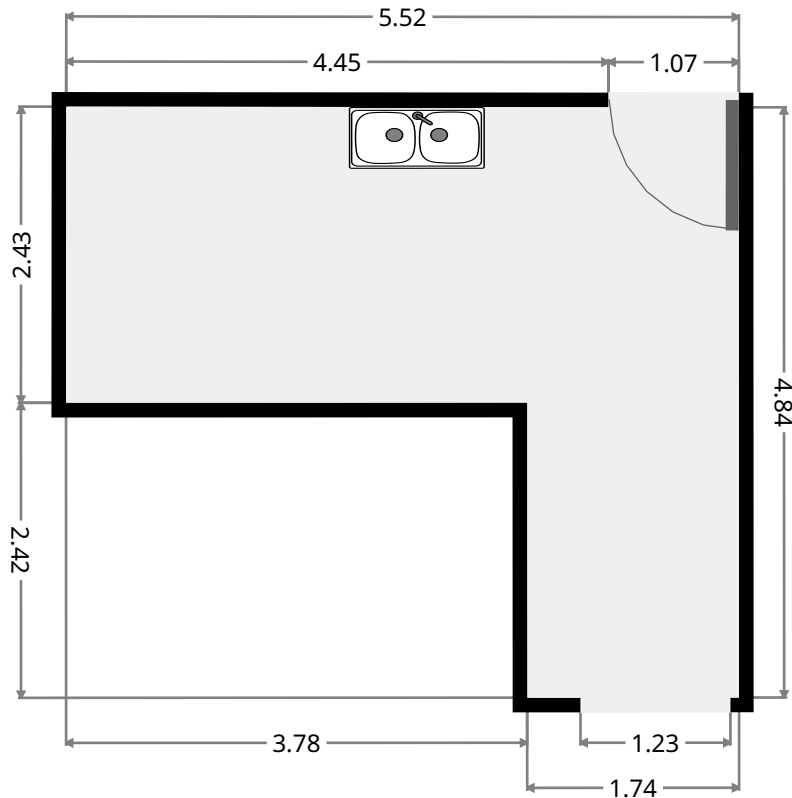
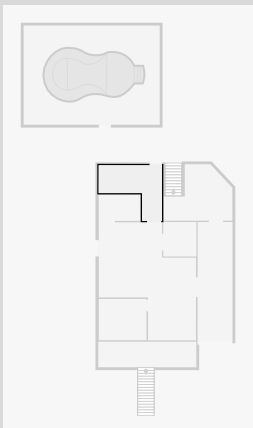

THIS FLOORPLAN IS PROVIDED WITHOUT WARRANTY OF ANY KIND. SENSOPIA DISCLAIMS ANY WARRANTY INCLUDING, WITHOUT LIMITATION, SATISFACTORY QUALITY OR ACCURACY OF DIMENSIONS.

18 Weinholt Street

Storage

Width: 2.89 m
 Length: 3.02 m
 Area: 8.70 m²
 Perimeter: 11.80 m

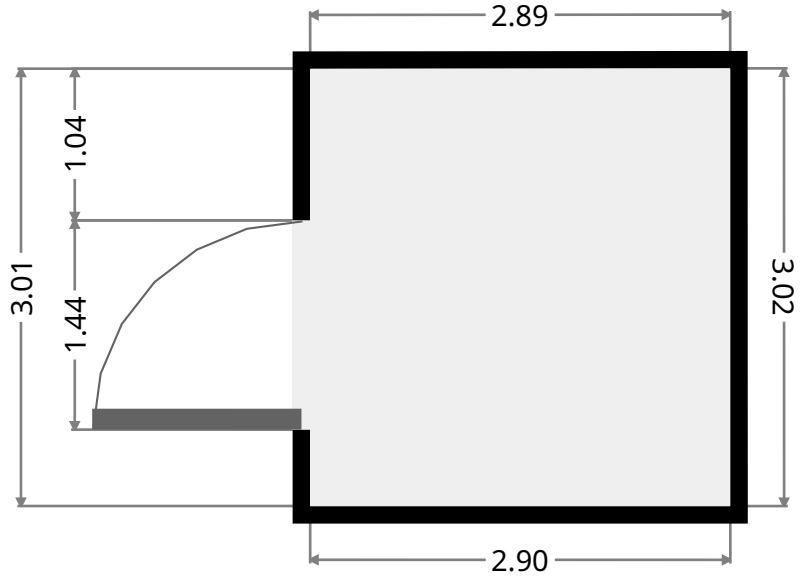
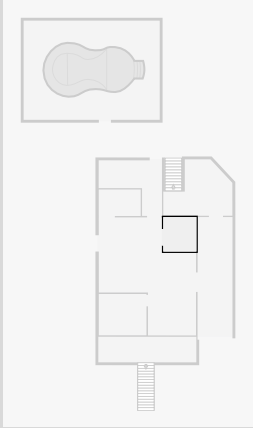

Storage

Width: 3.60 m
 Length: 4.16 m
 Area: 14.98 m²
 Perimeter: 15.52 m

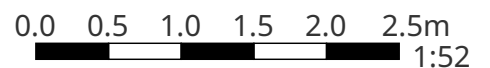
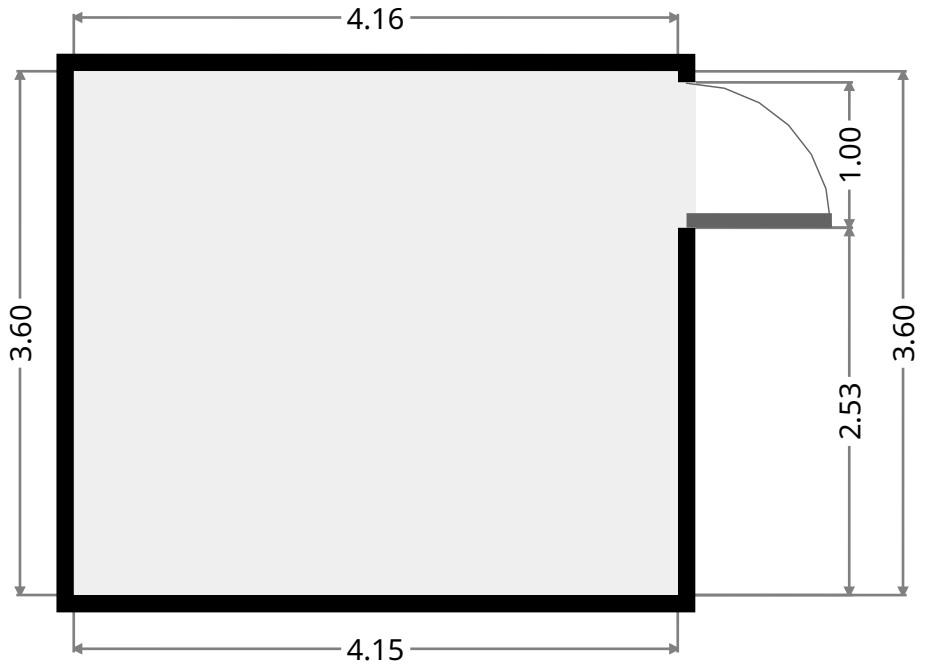
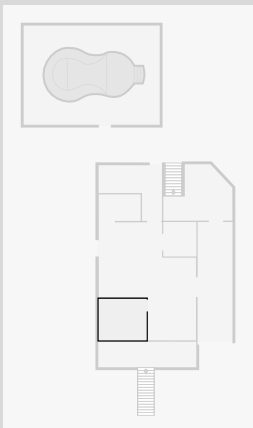

18 Weinholt Street

Carport

Width: 3.04 m
Length: 10.33 m
Area: 31.41 m²
Perimeter: 26.74 m

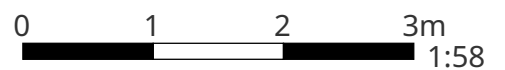
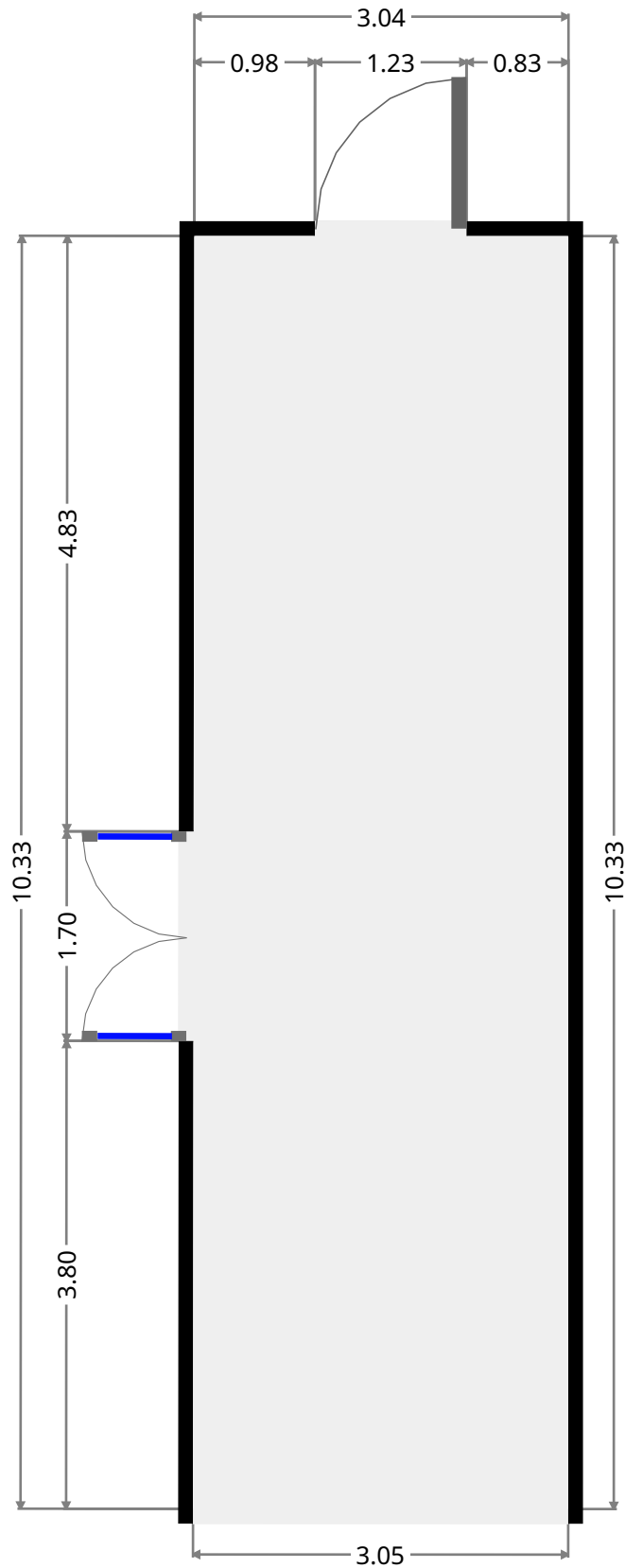
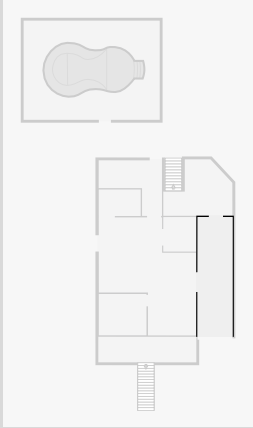

THIS FLOORPLAN IS PROVIDED WITHOUT WARRANTY OF ANY KIND. SENSOPIA DISCLAIMS ANY WARRANTY INCLUDING, WITHOUT LIMITATION, SATISFACTORY QUALITY OR ACCURACY OF DIMENSIONS.

18 Weinholt Street

Underdeck Area

Width: 4.92 m
 Length: 6.02 m
 Area: 22.39 m²
 Perimeter: 20.72 m

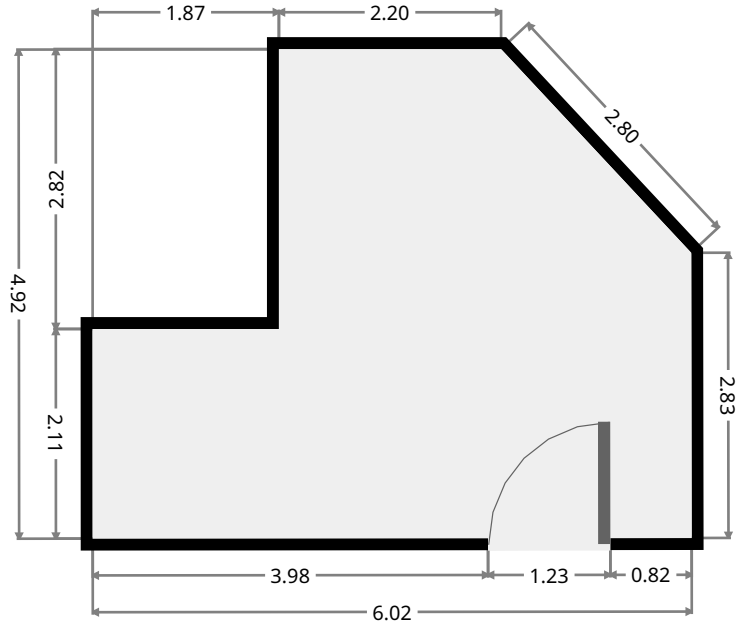

• Width: 2.23 m
 Length: 8.55 m
 Area: 19.07 m²
 Perimeter: 21.55 m

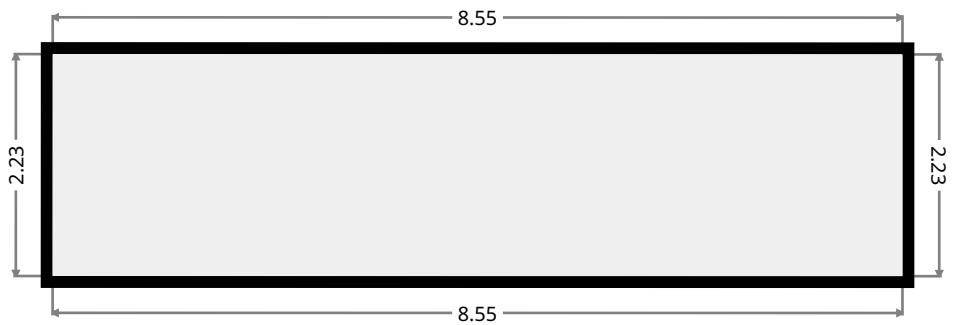
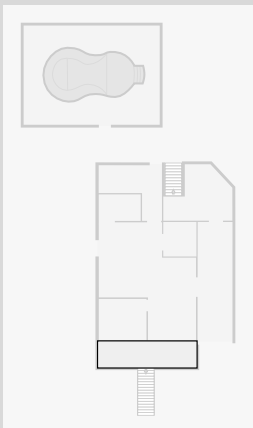

18 Weinholt Street

Other

Width: 8.65 m
Length: 11.87 m
Area: 102.67 m²
Perimeter: 41.04 m

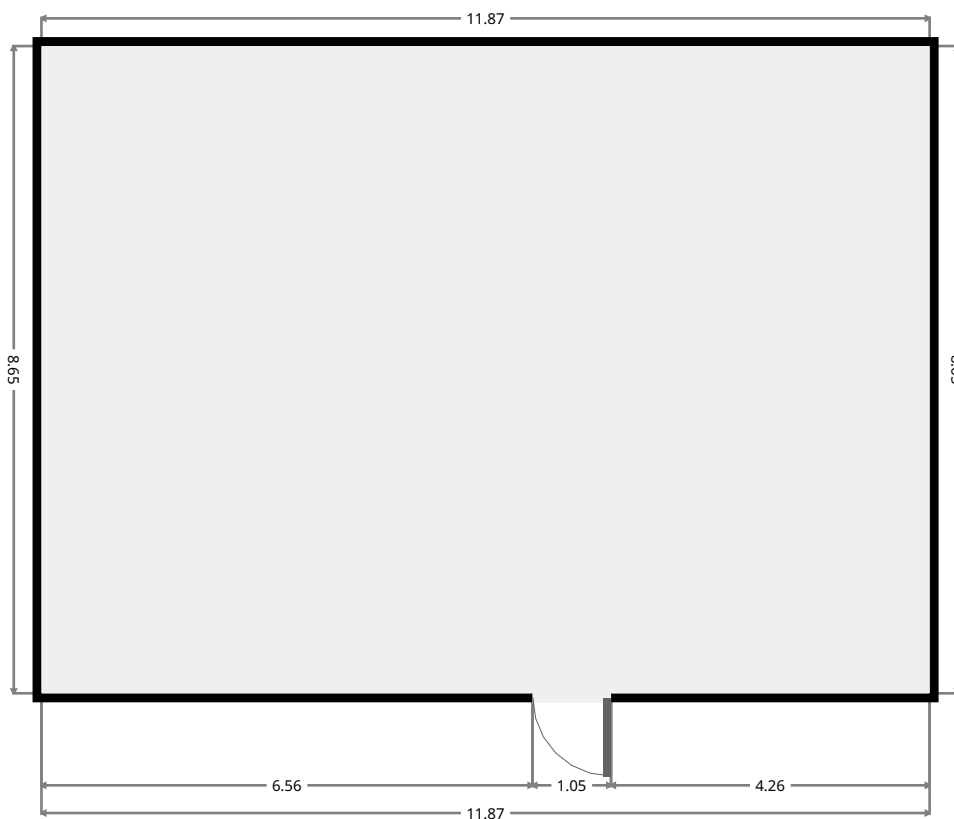
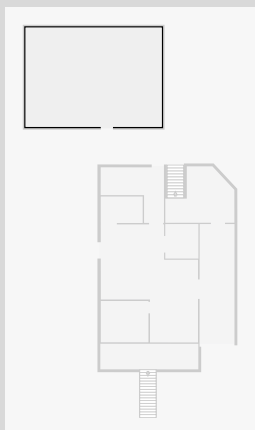

THIS FLOORPLAN IS PROVIDED WITHOUT WARRANTY OF ANY KIND. SENSOPIA DISCLAIMS ANY WARRANTY INCLUDING, WITHOUT LIMITATION, SATISFACTORY QUALITY OR ACCURACY OF DIMENSIONS.



18 Weinholt Street

1st Floor

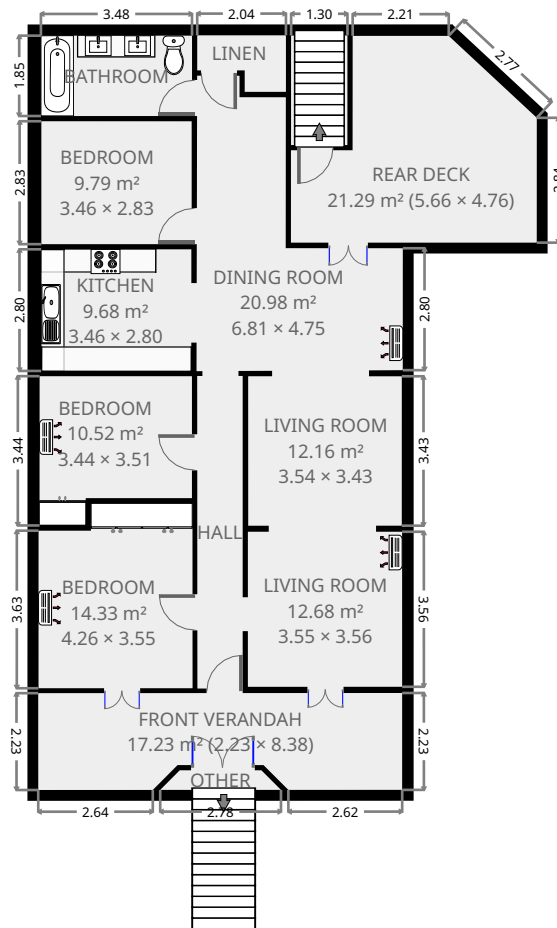

THIS FLOORPLAN IS PROVIDED WITHOUT WARRANTY OF ANY KIND. SENSOPIA DISCLAIMS ANY WARRANTY INCLUDING, WITHOUT LIMITATION, SATISFACTORY QUALITY OR ACCURACY OF DIMENSIONS.



18 Weinholt Street

Hall

Width: 1.05 m
 Length: 7.20 m
 Area: 7.52 m²
 Perimeter: 16.48 m

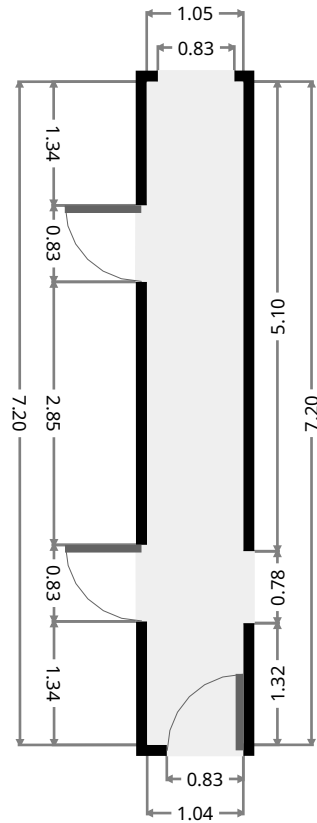
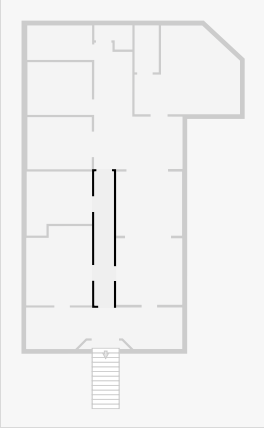

Bedroom

Width: 3.55 m
 Length: 4.26 m
 Area: 14.33 m²
 Perimeter: 15.60 m

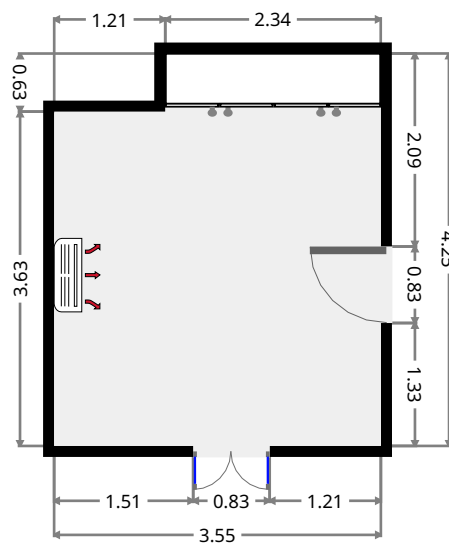
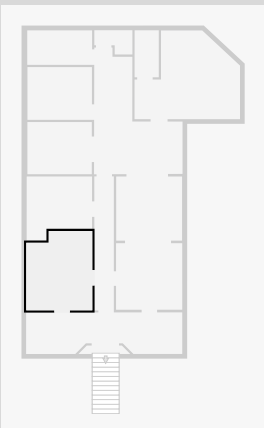

THIS FLOORPLAN IS PROVIDED WITHOUT WARRANTY OF ANY KIND. SENSOPIA DISCLAIMS ANY WARRANTY INCLUDING, WITHOUT LIMITATION, SATISFACTORY QUALITY OR ACCURACY OF DIMENSIONS.



18 Weinholt Street

Living Room

Width: 3.55 m
 Length: 3.56 m
 Area: 12.68 m²
 Perimeter: 14.24 m

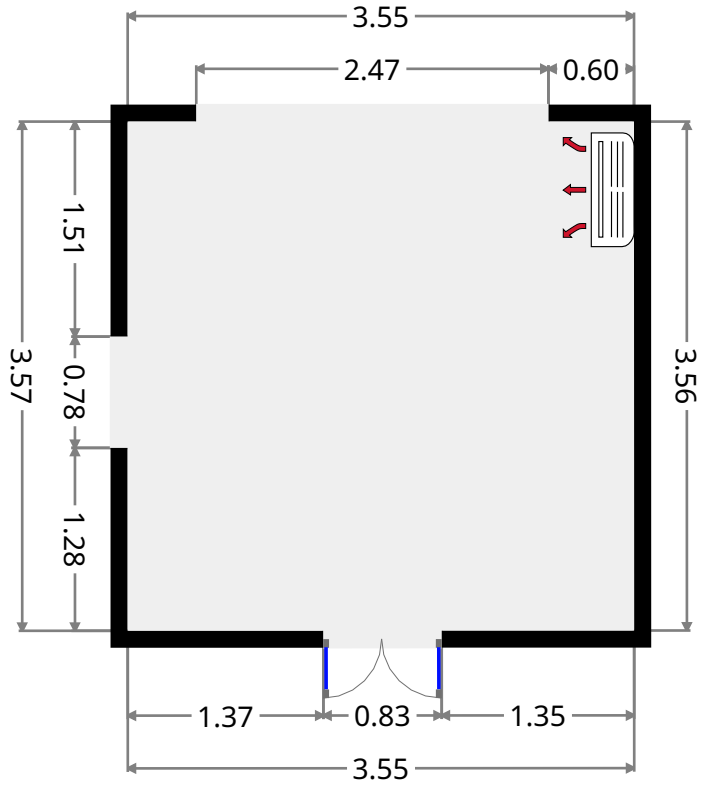
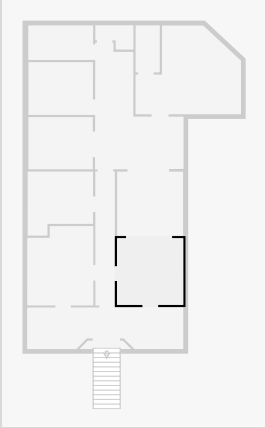

Living Room

Width: 3.43 m
 Length: 3.54 m
 Area: 12.16 m²
 Perimeter: 13.95 m

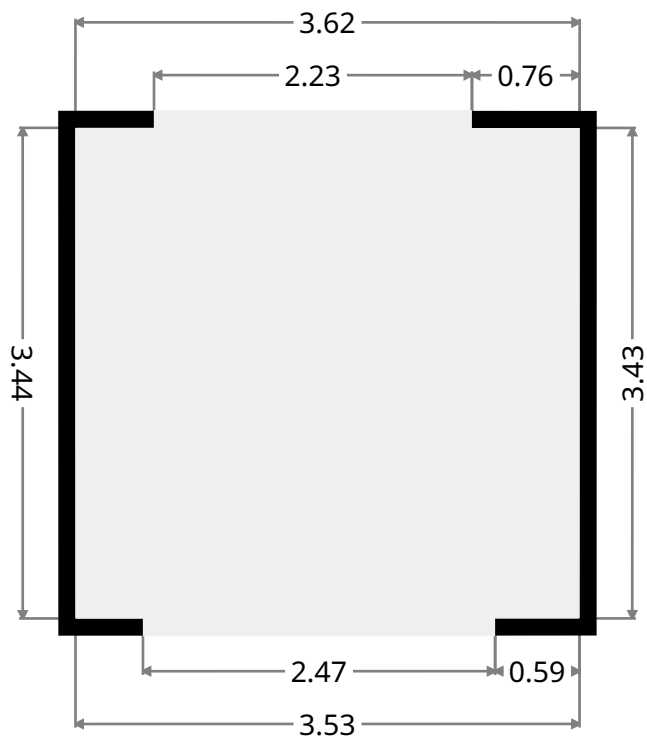
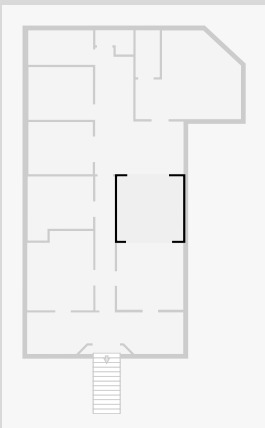

THIS FLOORPLAN IS PROVIDED WITHOUT WARRANTY OF ANY KIND. SENSOPIA DISCLAIMS ANY WARRANTY INCLUDING, WITHOUT LIMITATION, SATISFACTORY QUALITY OR ACCURACY OF DIMENSIONS.

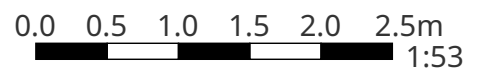

18 Weinholt Street

Bedroom

Width: 3.44 m
 Length: 3.51 m
 Area: 10.52 m²
 Perimeter: 13.89 m

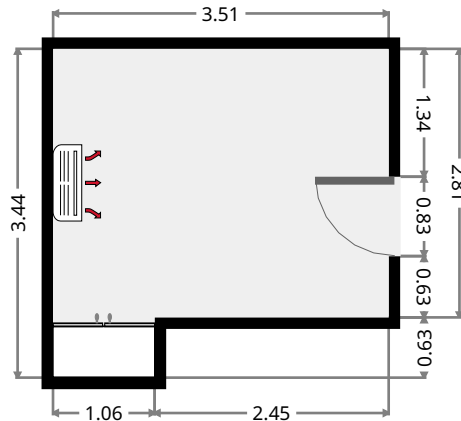
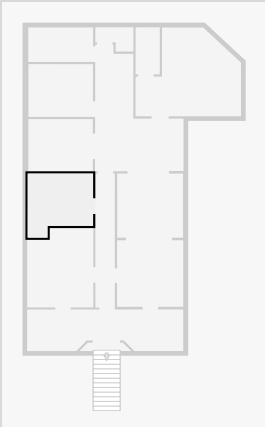

Dining Room

Width: 4.75 m
 Length: 6.81 m
 Area: 20.98 m²
 Perimeter: 23.07 m

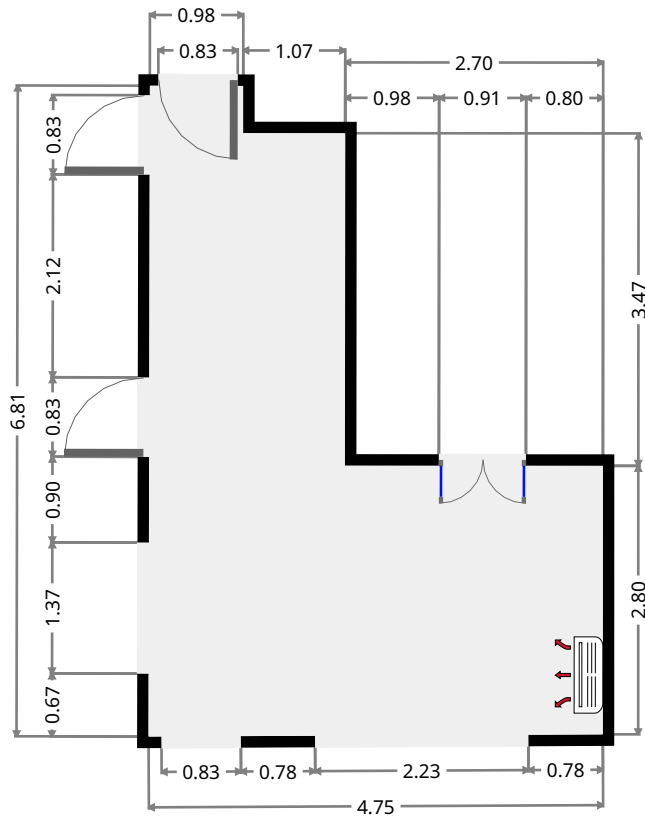
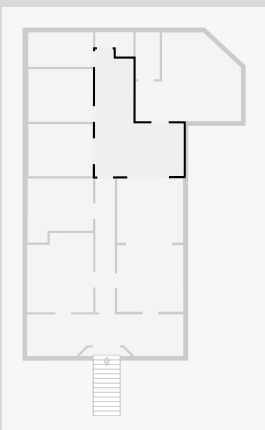

THIS FLOORPLAN IS PROVIDED WITHOUT WARRANTY OF ANY KIND. SENSOPIA DISCLAIMS ANY WARRANTY INCLUDING, WITHOUT LIMITATION, SATISFACTORY QUALITY OR ACCURACY OF DIMENSIONS.

18 Weinholt Street

Kitchen

Width: 2.80 m
Length: 3.46 m
Area: 9.68 m²
Perimeter: 12.51 m

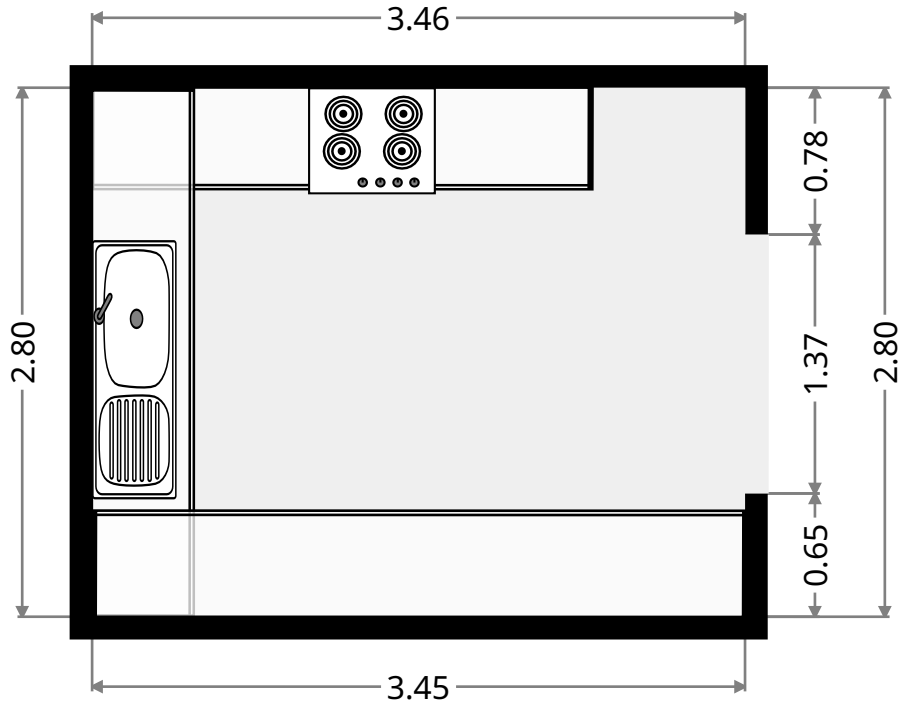
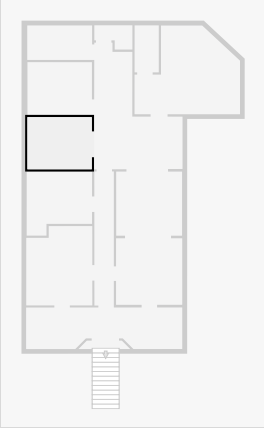

Bedroom

Width: 2.83 m
Length: 3.46 m
Area: 9.79 m²
Perimeter: 12.58 m

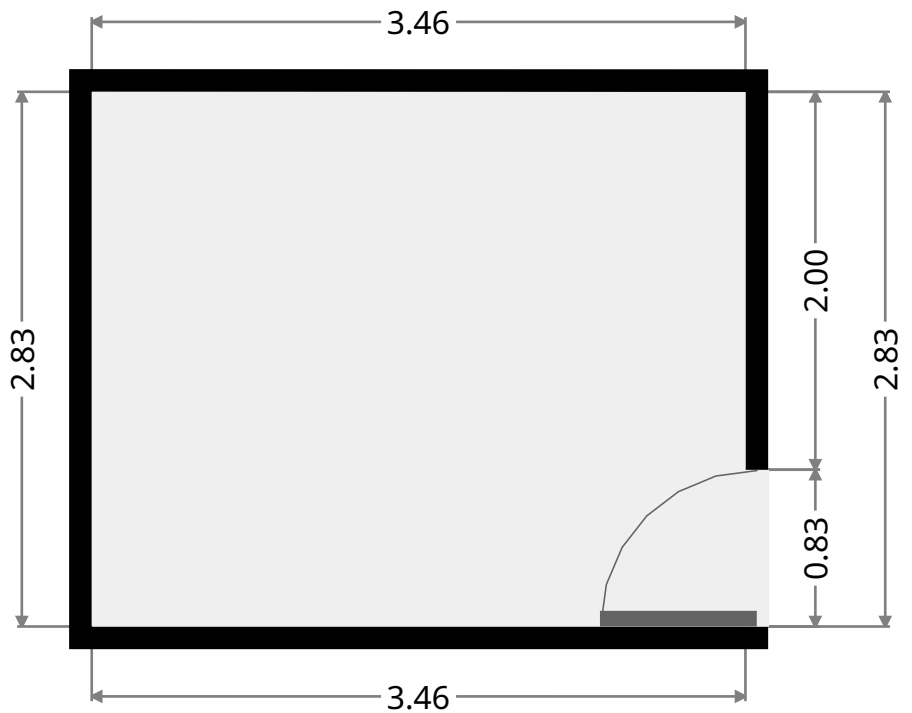
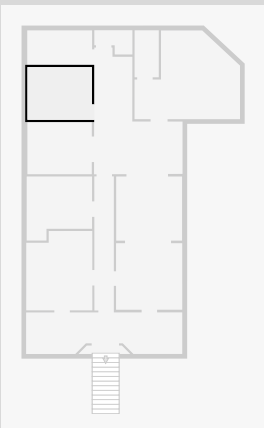

THIS FLOORPLAN IS PROVIDED WITHOUT WARRANTY OF ANY KIND. SENSOPIA DISCLAIMS ANY WARRANTY INCLUDING, WITHOUT LIMITATION, SATISFACTORY QUALITY OR ACCURACY OF DIMENSIONS.

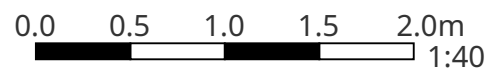

18 Weinholt Street

Bathroom

Width: 1.85 m
 Length: 3.48 m
 Area: 6.44 m²
 Perimeter: 10.66 m

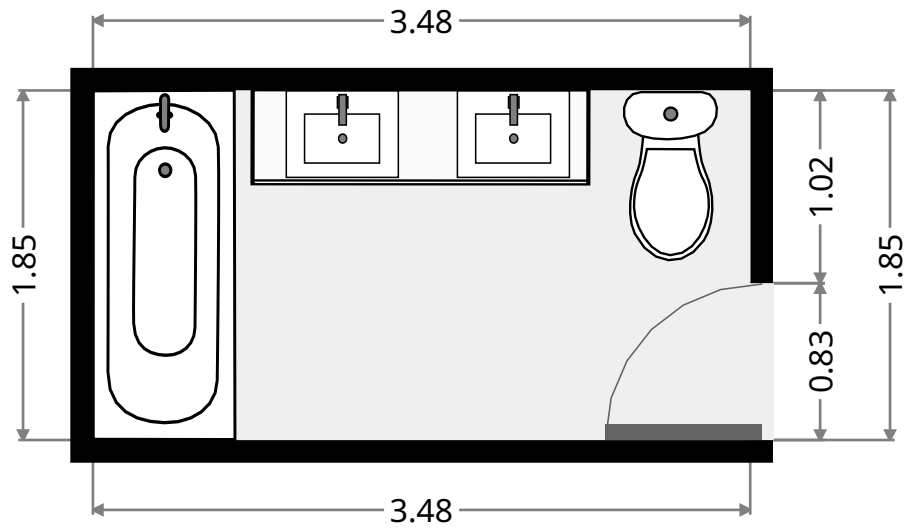
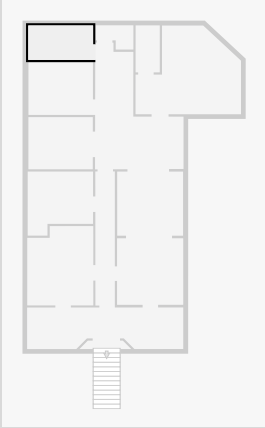

Linen

Width: 1.30 m
 Length: 2.04 m
 Area: 2.12 m²
 Perimeter: 6.69 m

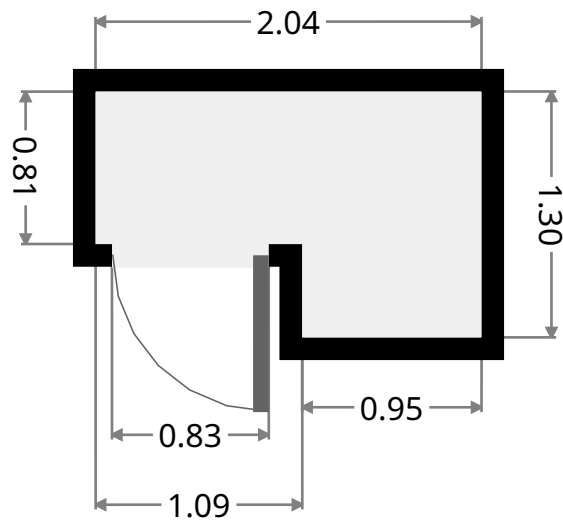
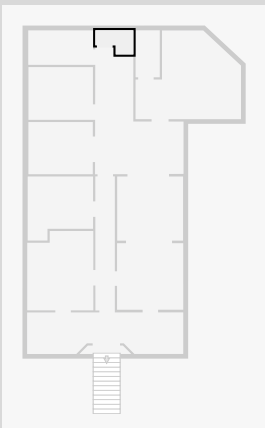

18 Weinholt Street

Rear Deck

Width: 4.76 m
 Length: 5.66 m
 Area: 21.29 m²
 Perimeter: 19.69 m

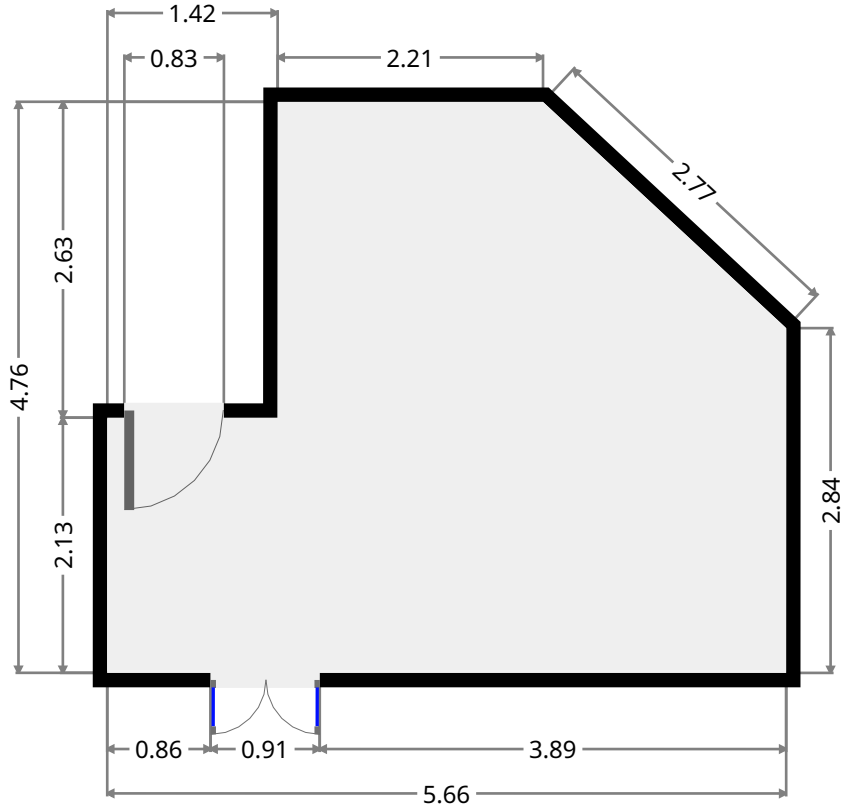
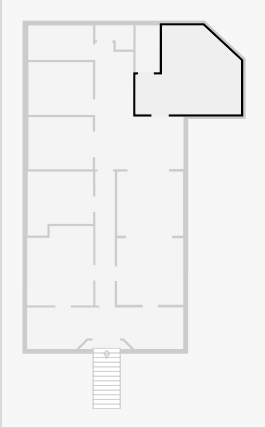

Stairway

Width: 1.30 m
 Length: 2.52 m
 Area: 3.27 m²
 Perimeter: 7.64 m

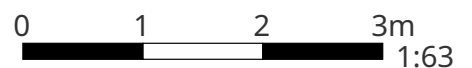
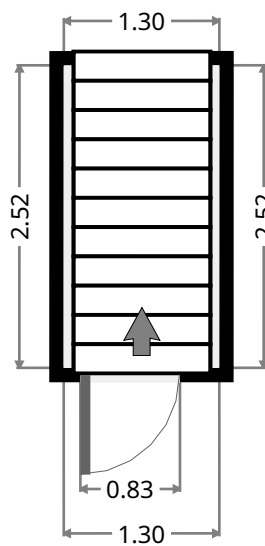
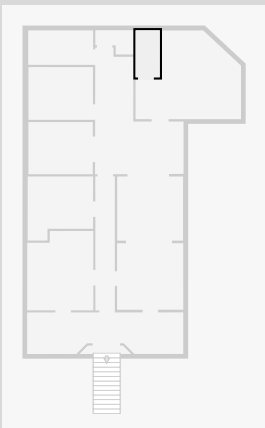

18 Weinholt Street

Front Verandah

Width: 2.23 m
 Length: 8.38 m
 Area: 17.23 m²
 Perimeter: 21.69 m

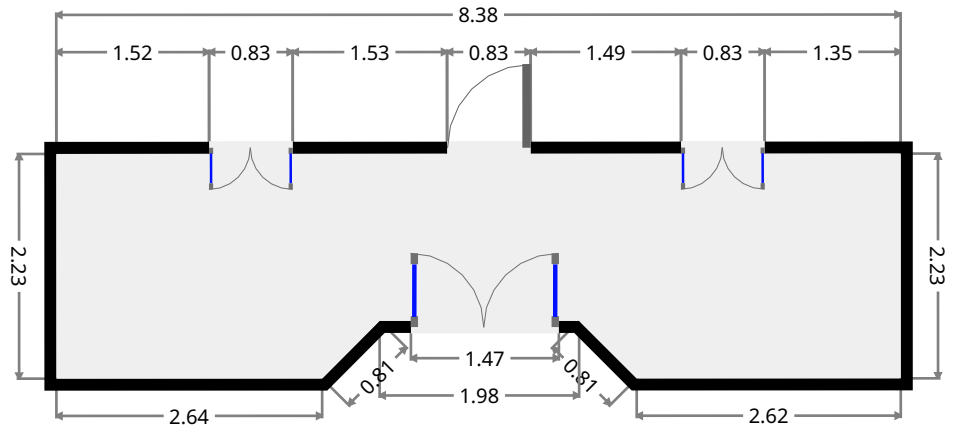
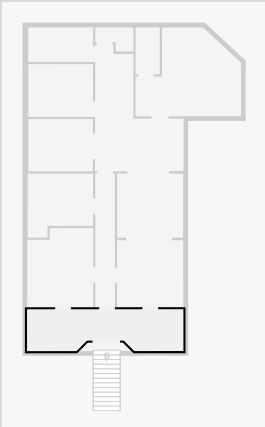

Other

Width: 0.45 m
 Length: 2.78 m
 Area: 1.05 m²
 Perimeter: 5.94 m

