

18 Neill Street

Ground Floor

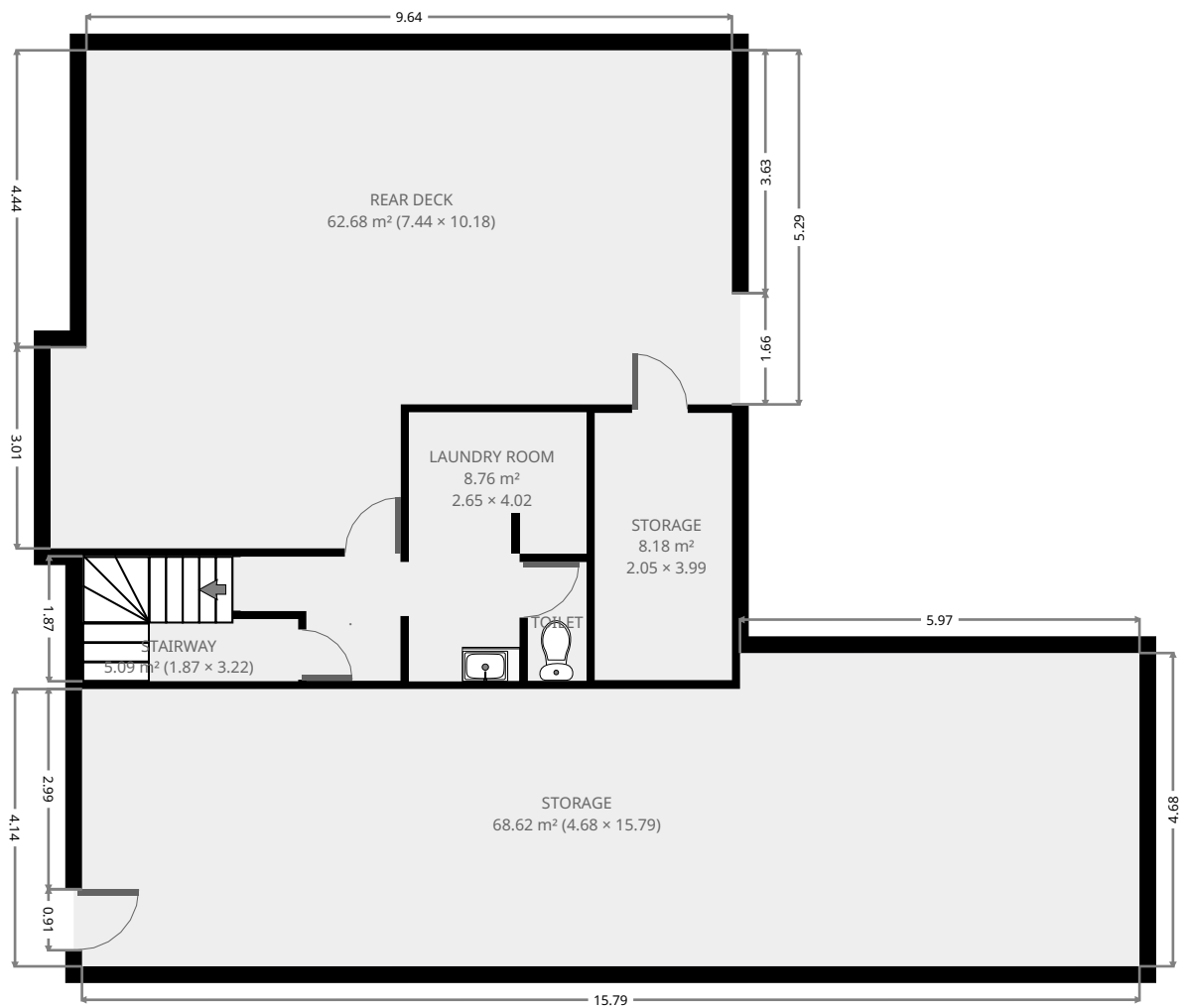

THIS FLOORPLAN IS PROVIDED WITHOUT WARRANTY OF ANY KIND. SENSOPIA DISCLAIMS ANY WARRANTY INCLUDING, WITHOUT LIMITATION, SATISFACTORY QUALITY OR ACCURACY OF DIMENSIONS.



18 Neill Street

Laundry Room

Width: 2.65 m
 Length: 4.02 m
 Area: 8.76 m²
 Perimeter: 13.35 m

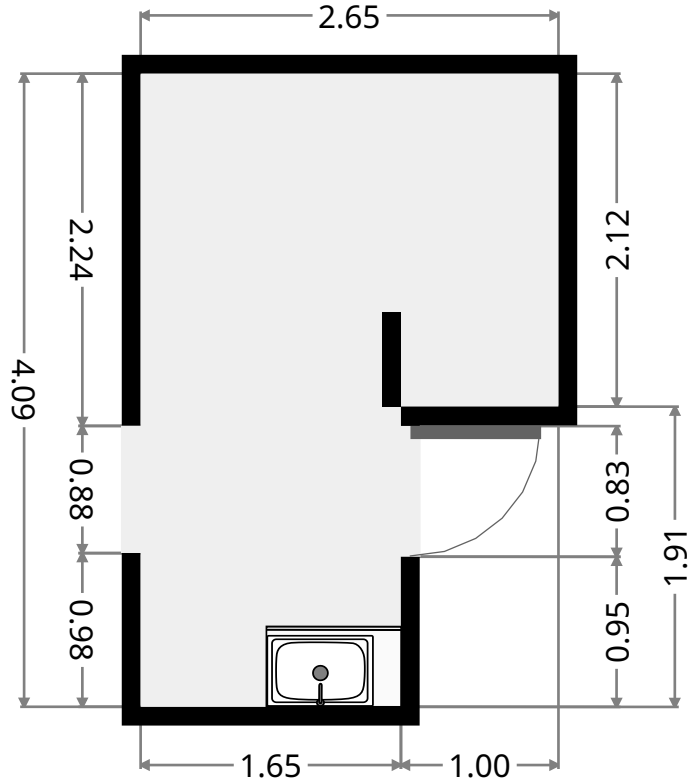
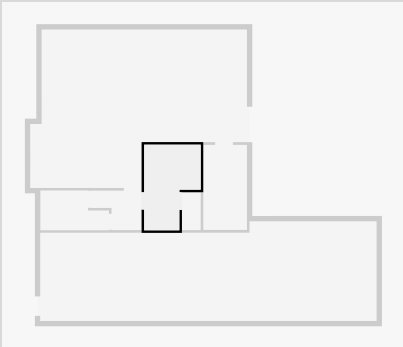

Toilet

Width: 0.88 m
 Length: 1.77 m
 Area: 1.55 m²
 Perimeter: 5.30 m

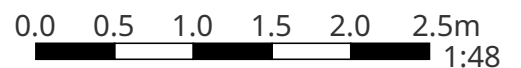
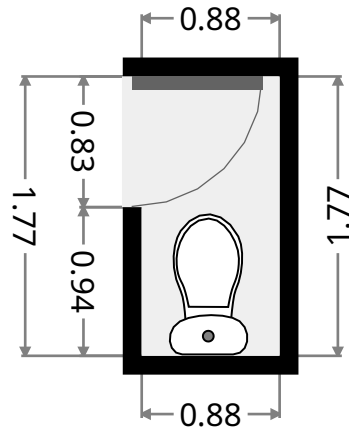
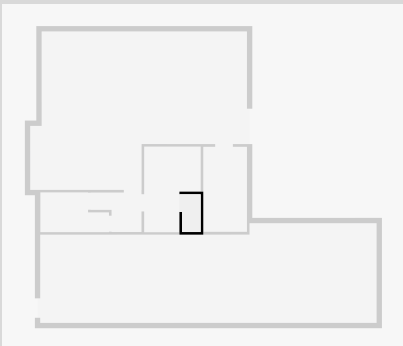

18 Neill Street

Width: 1.85 m
 Length: 2.39 m
 Area: 3.40 m²
 Perimeter: 8.48 m

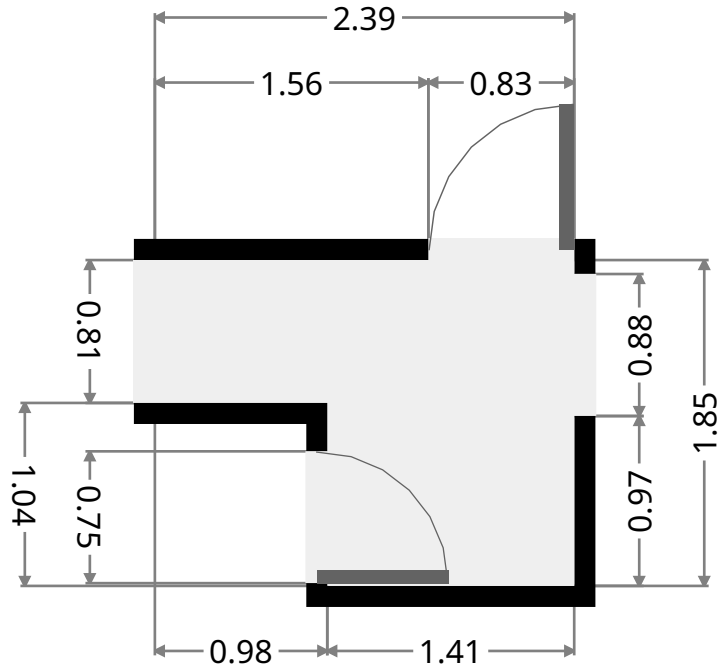
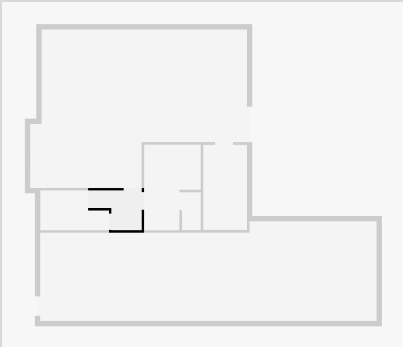

Stairway

Width: 1.87 m
 Length: 3.22 m
 Area: 5.09 m²
 Perimeter: 10.17 m

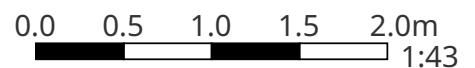
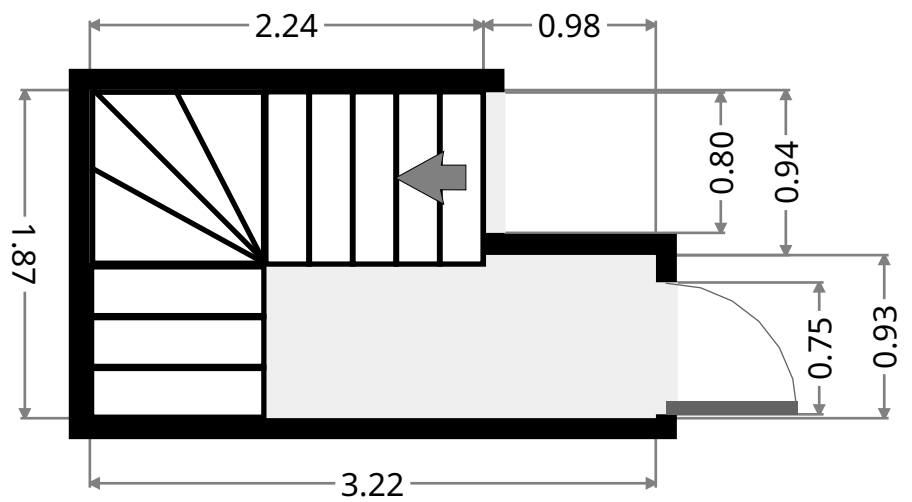
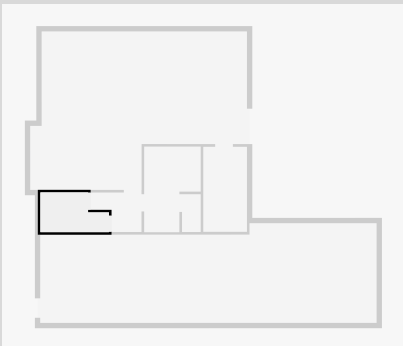

18 Neill Street

Rear Deck

Width: 7.44 m
Length: 10.18 m
Area: 62.68 m²
Perimeter: 35.23 m

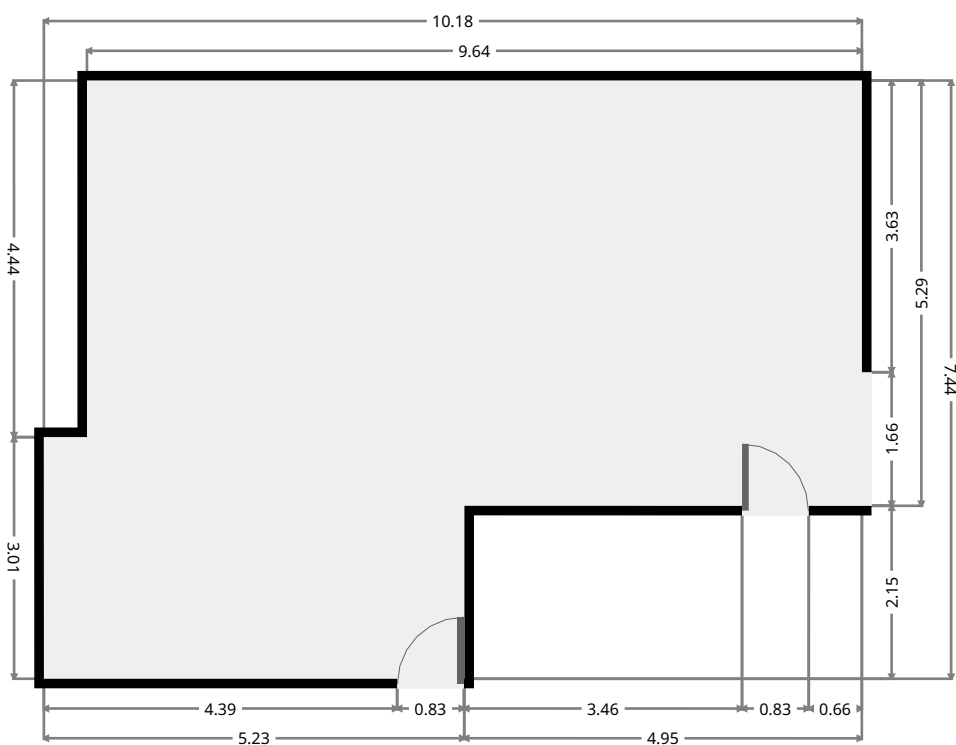
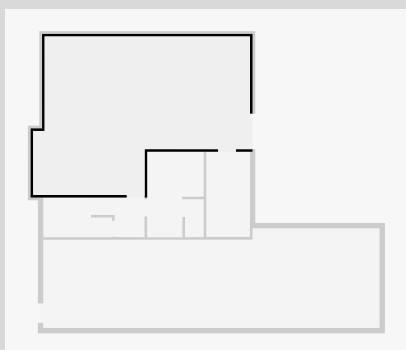

THIS FLOORPLAN IS PROVIDED WITHOUT WARRANTY OF ANY KIND. SENSOPIA DISCLAIMS ANY WARRANTY INCLUDING, WITHOUT LIMITATION, SATISFACTORY QUALITY OR ACCURACY OF DIMENSIONS.



18 Neill Street

Storage

Width: 2.05 m
Length: 3.99 m
Area: 8.18 m²
Perimeter: 12.08 m

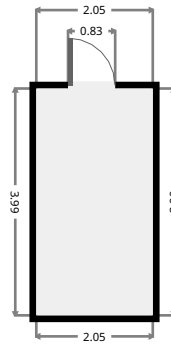
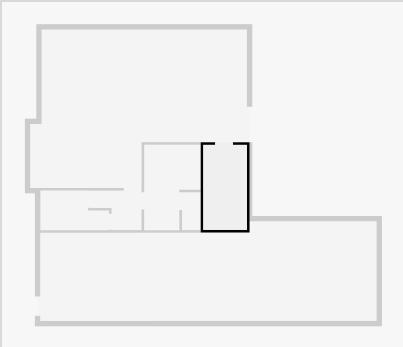

Storage

Width: 4.68 m
Length: 15.79 m
Area: 68.62 m²
Perimeter: 40.94 m

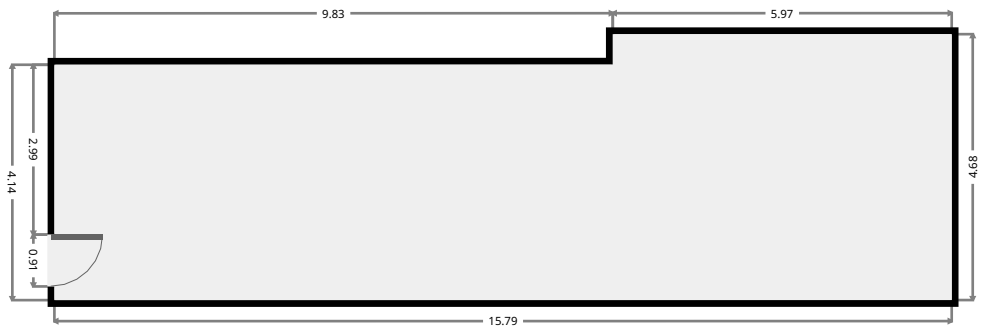
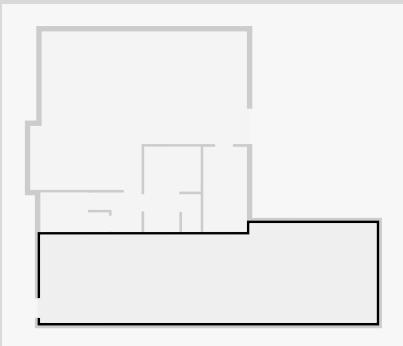

18 Neill Street

Living Room

Width: 4.79 m
 Length: 6.88 m
 Area: 31.60 m²
 Perimeter: 22.38 m

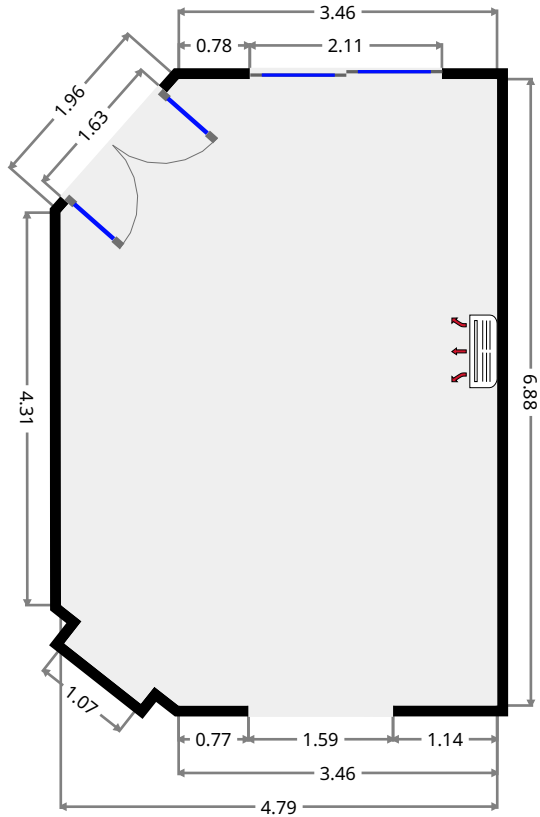
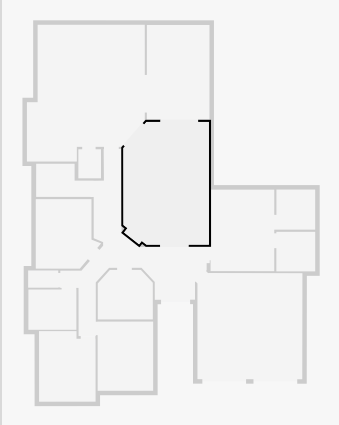

Study

Width: 2.78 m
 Length: 3.09 m
 Area: 8.06 m²
 Perimeter: 10.89 m

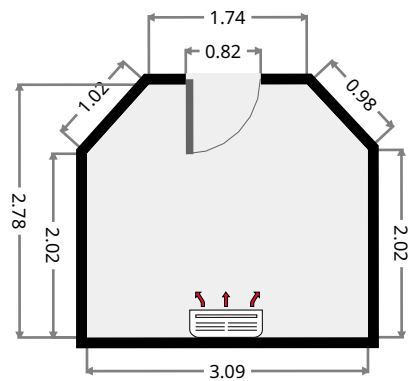
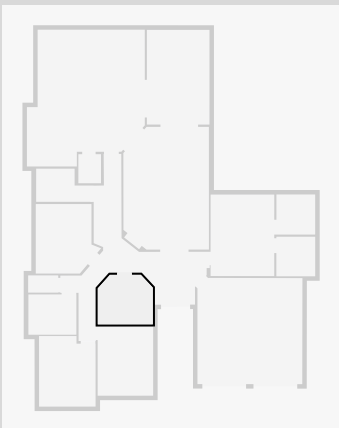

18 Neill Street

Bedroom

Width: 3.11 m
 Length: 3.88 m
 Area: 12.06 m²
 Perimeter: 13.98 m

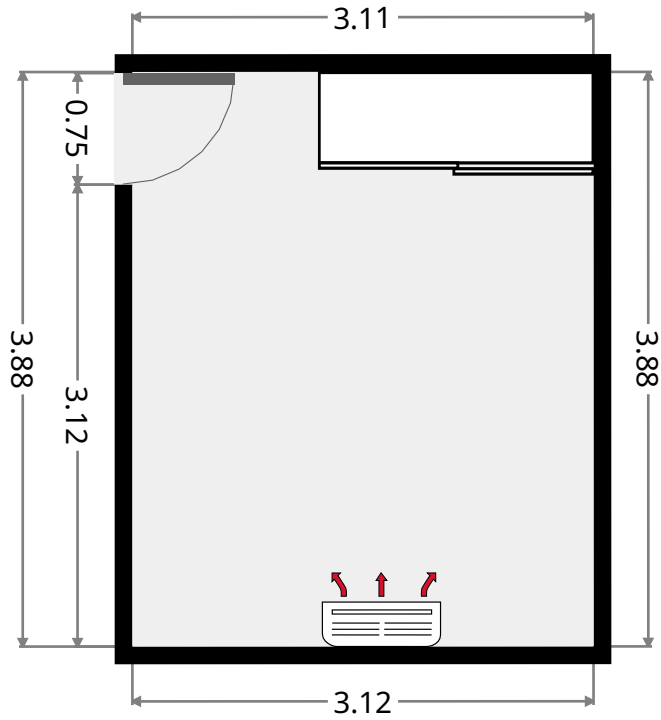
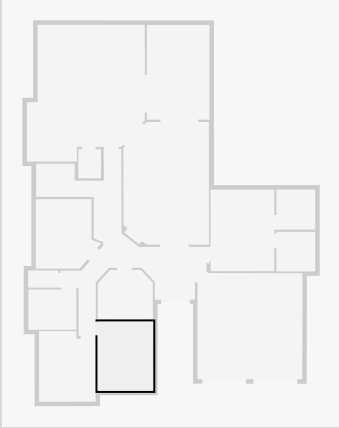

Bedroom

Width: 3.17 m
 Length: 3.97 m
 Area: 12.07 m²
 Perimeter: 14.25 m

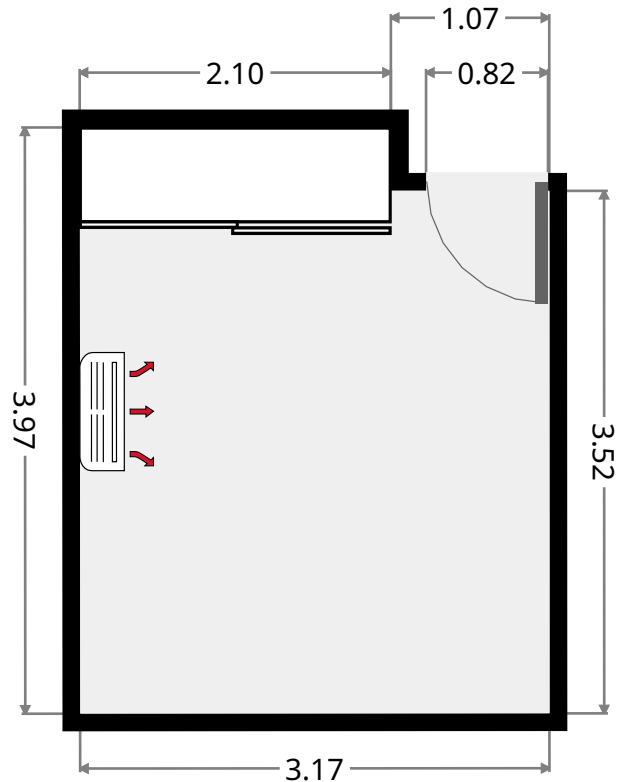
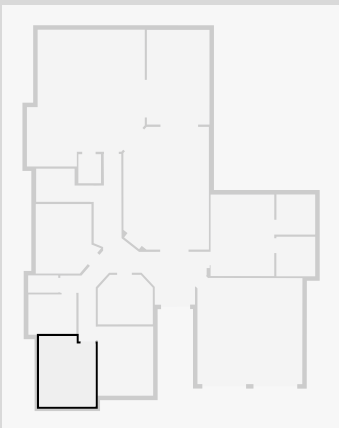

THIS FLOORPLAN IS PROVIDED WITHOUT WARRANTY OF ANY KIND. SENSOPIA DISCLAIMS ANY WARRANTY INCLUDING, WITHOUT LIMITATION, SATISFACTORY QUALITY OR ACCURACY OF DIMENSIONS.

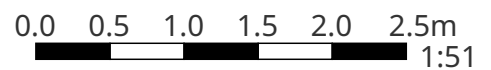

18 Neill Street

Bathroom

Width: 2.27 m
Length: 2.69 m
Area: 6.07 m²
Perimeter: 9.89 m

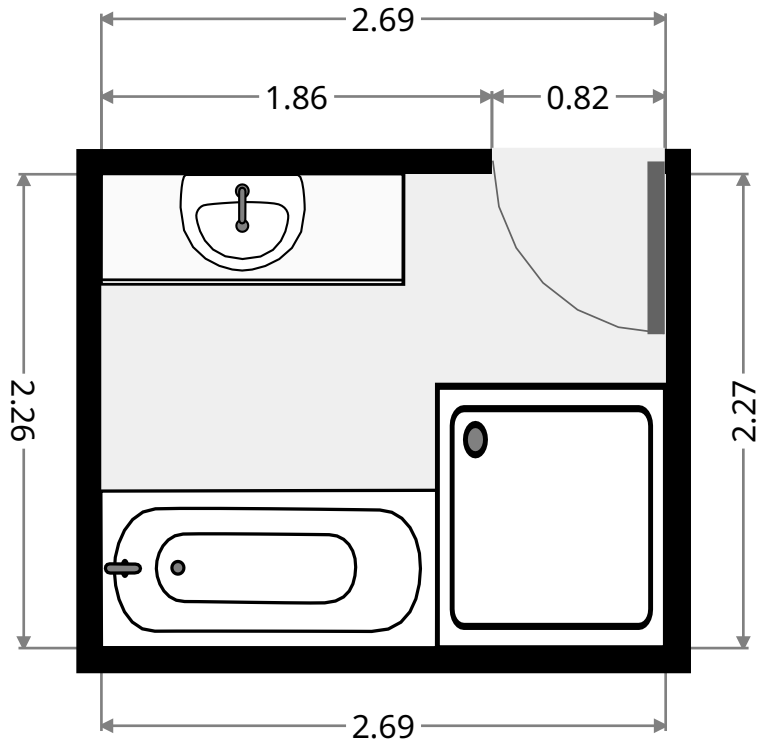
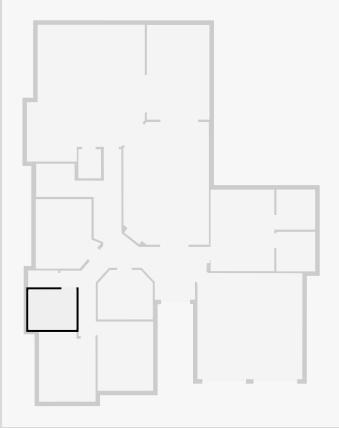

Toilet

Width: 0.97 m
Length: 1.69 m
Area: 1.63 m²
Perimeter: 5.30 m

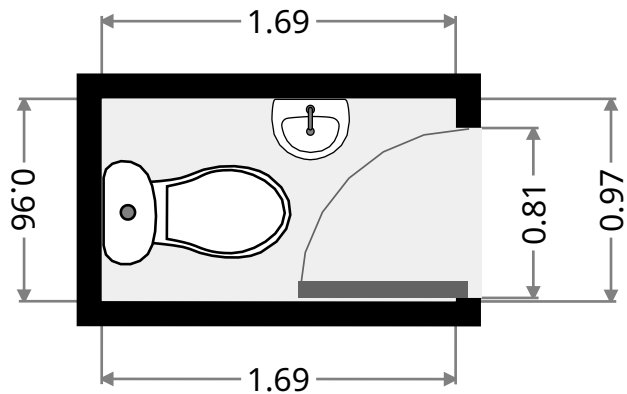
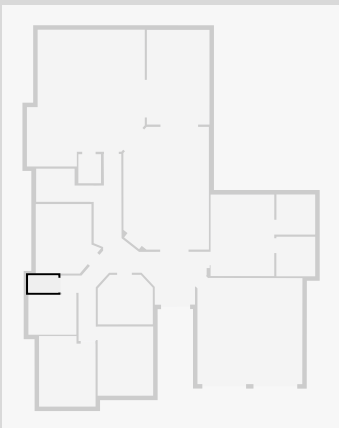

18 Neill Street

Bedroom

Width: 3.12 m
 Length: 3.90 m
 Area: 12.14 m²
 Perimeter: 14.18 m

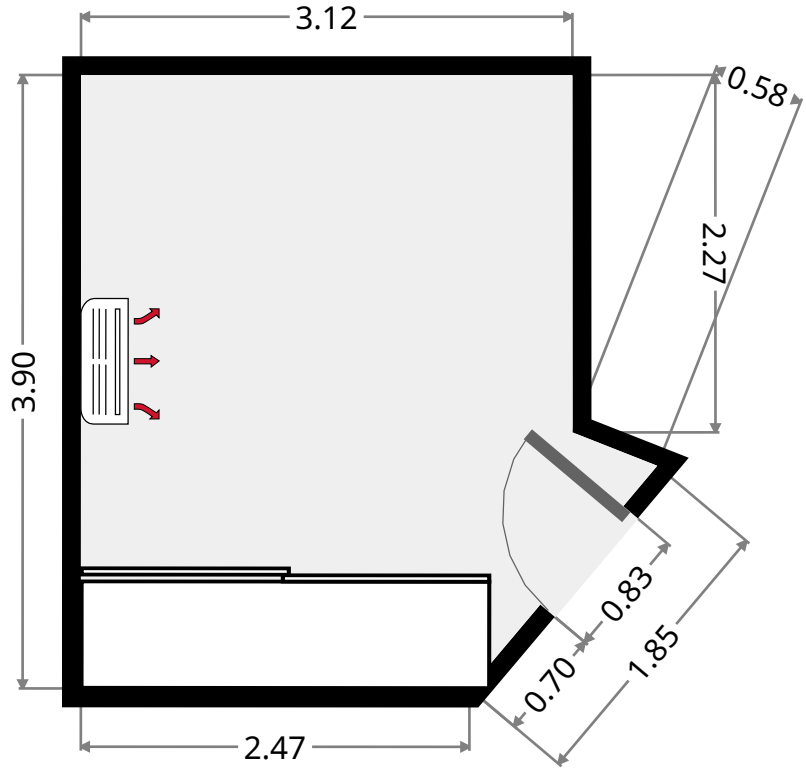
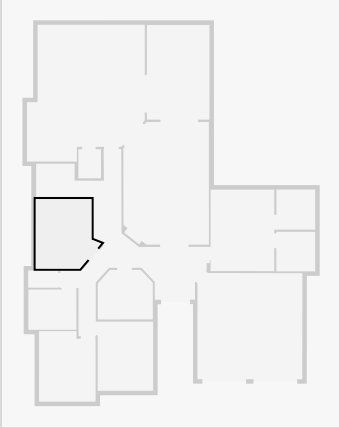

Stairway

Width: 1.86 m
 Length: 3.11 m
 Area: 4.86 m²
 Perimeter: 9.91 m

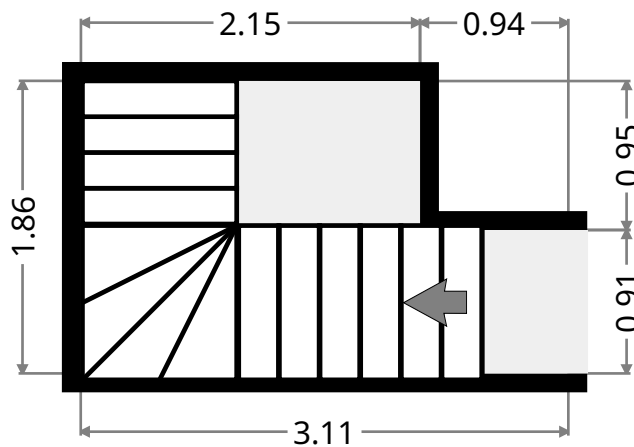
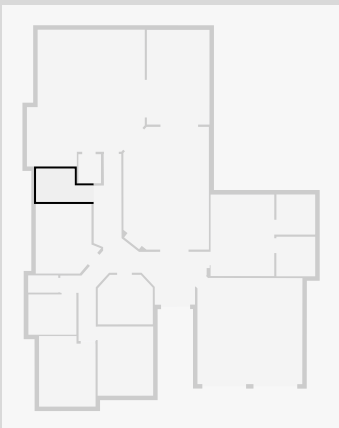

18 Neill Street

Pantry

Width: 1.27 m
 Length: 1.63 m
 Area: 2.06 m²
 Perimeter: 5.79 m

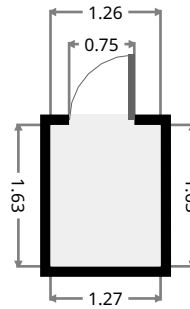
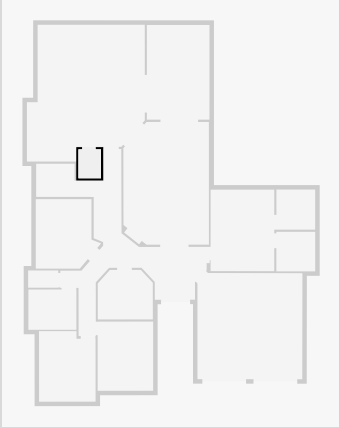

Kitchen/Dining

Width: 6.61 m
 Length: 7.67 m
 Area: 43.94 m²
 Perimeter: 27.73 m

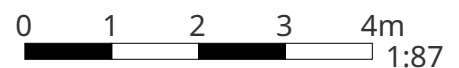
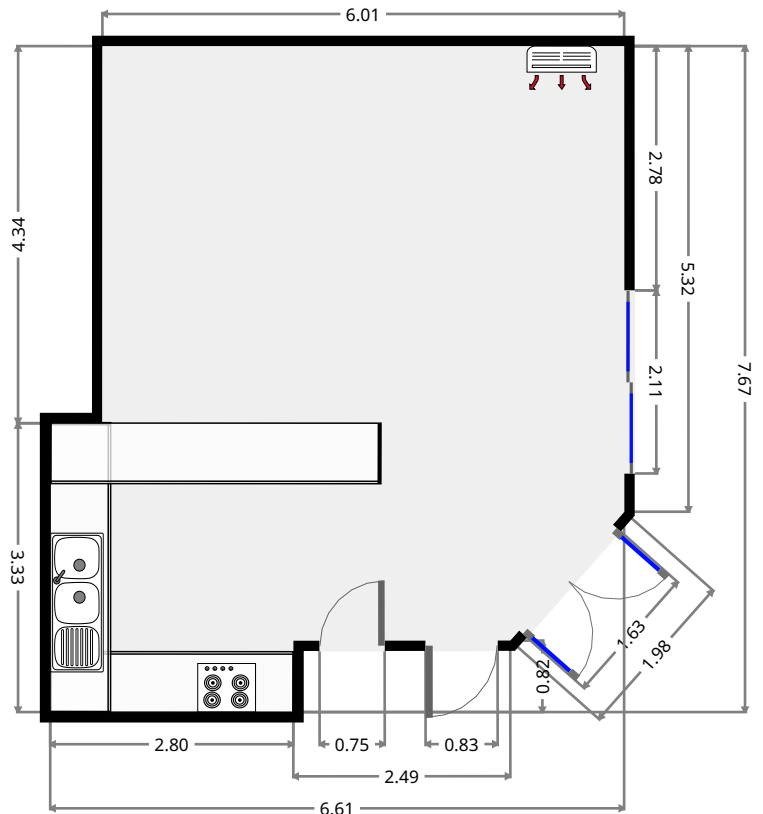
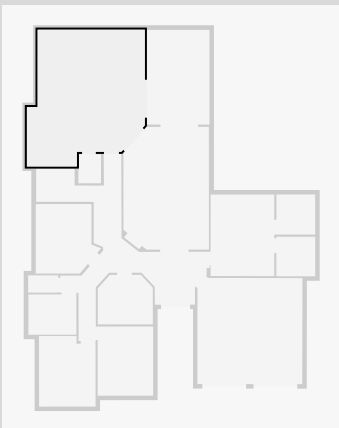

THIS FLOORPLAN IS PROVIDED WITHOUT WARRANTY OF ANY KIND. SENSOPIA DISCLAIMS ANY WARRANTY INCLUDING, WITHOUT LIMITATION, SATISFACTORY QUALITY OR ACCURACY OF DIMENSIONS.

18 Neill Street

Formal Dining

Width: 3.51 m
 Length: 5.31 m
 Area: 18.62 m²
 Perimeter: 17.63 m

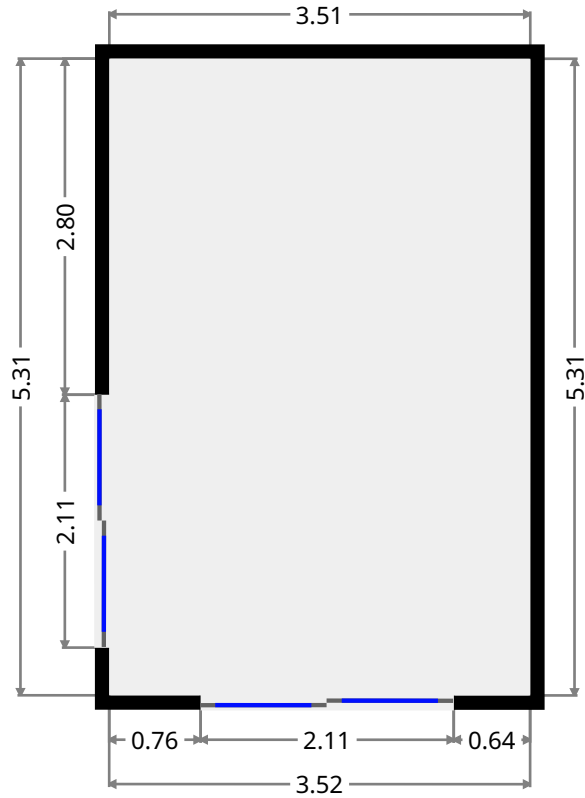
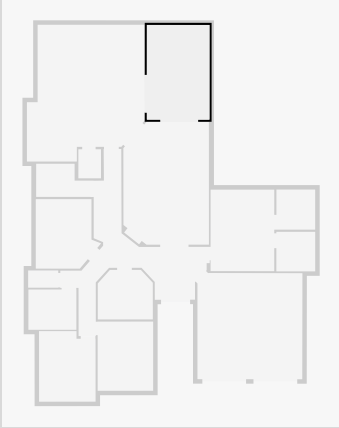

Master Bedroom

Width: 3.57 m
 Length: 4.58 m
 Area: 16.31 m²
 Perimeter: 16.28 m

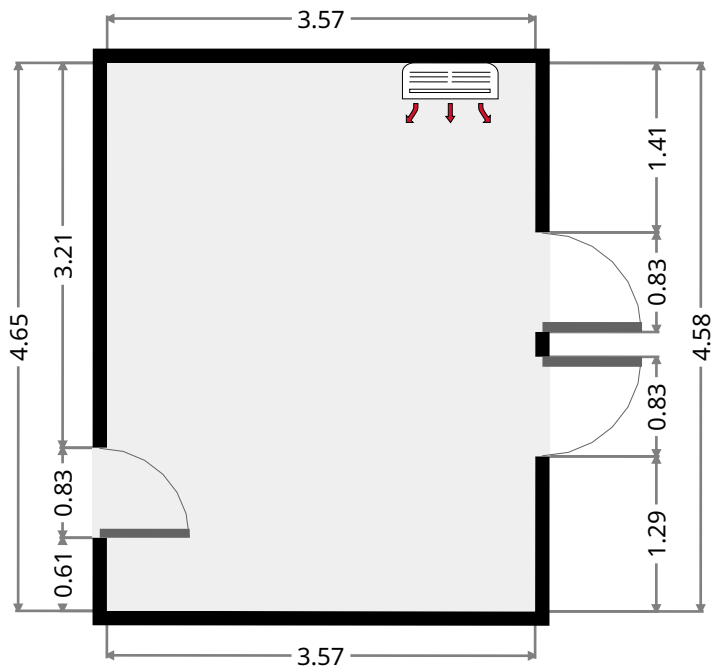
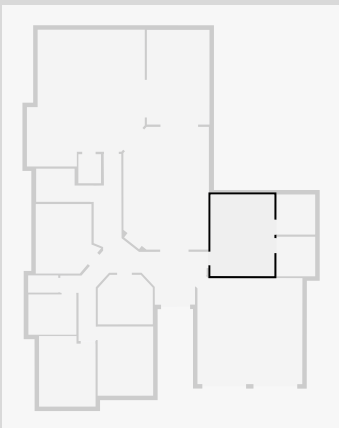

18 Neill Street

Bathroom

Width: 2.17 m
 Length: 2.25 m
 Area: 4.88 m²
 Perimeter: 8.84 m

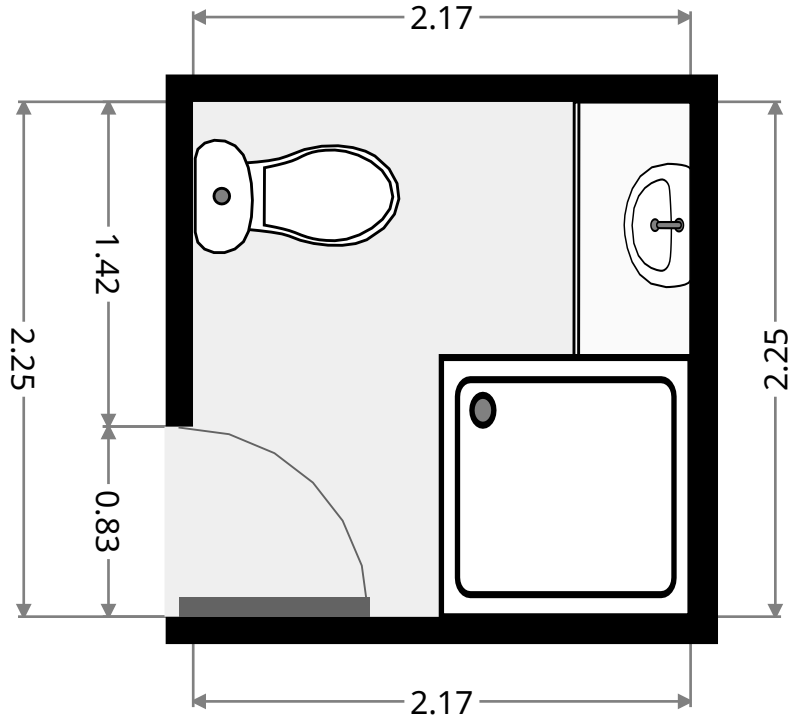
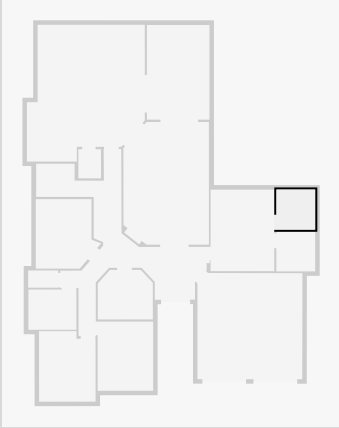

WIR

Width: 2.18 m
 Length: 2.22 m
 Area: 4.83 m²
 Perimeter: 8.79 m

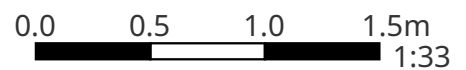
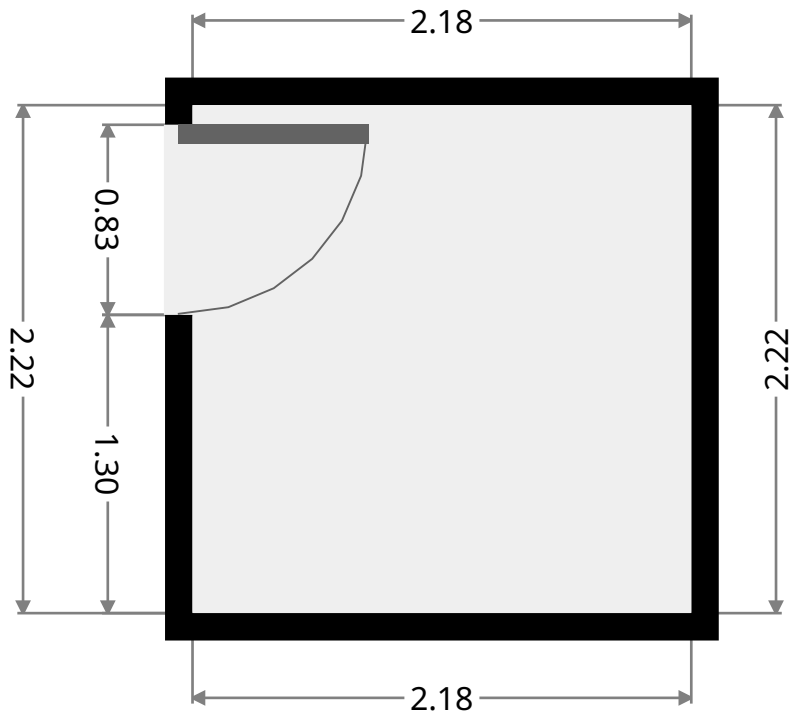
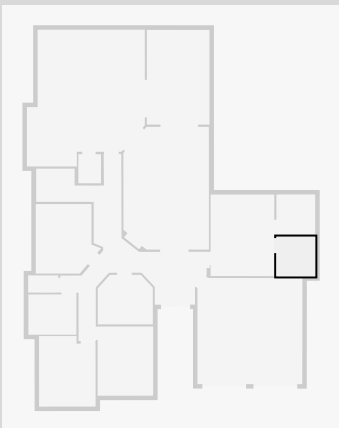

THIS FLOORPLAN IS PROVIDED WITHOUT WARRANTY OF ANY KIND. SENSOPIA DISCLAIMS ANY WARRANTY INCLUDING, WITHOUT LIMITATION, SATISFACTORY QUALITY OR ACCURACY OF DIMENSIONS.

18 Neill Street

Garage

Width: 5.88 m
Length: 5.95 m
Area: 34.80 m²
Perimeter: 23.31 m

