

18 Hartley Street

Created on
2021-03-18

Floors
2

▼ Ground Floor

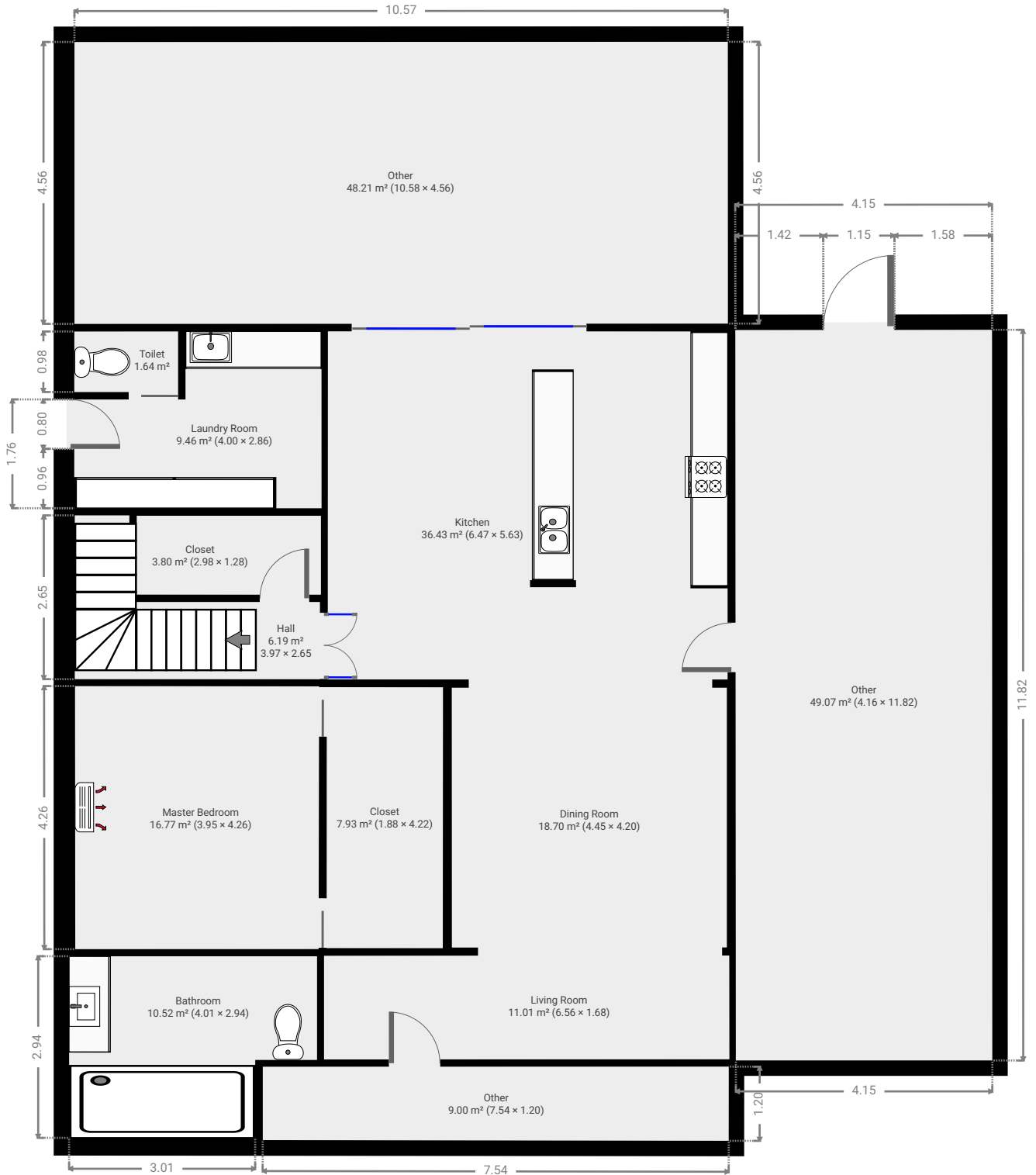

▼ Living Room
Ground Floor

WIDTH: 6.56 m • LENGTH: 1.68 m
AREA: 11.01 m² • PERIMETER: 16.48 m

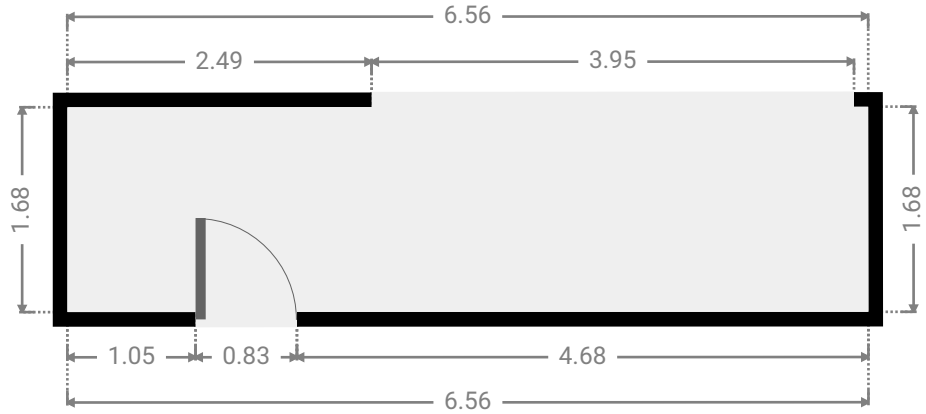

▼ Dining Room
Ground Floor

WIDTH: 4.45 m • LENGTH: 4.20 m
AREA: 18.70 m² • PERIMETER: 17.30 m

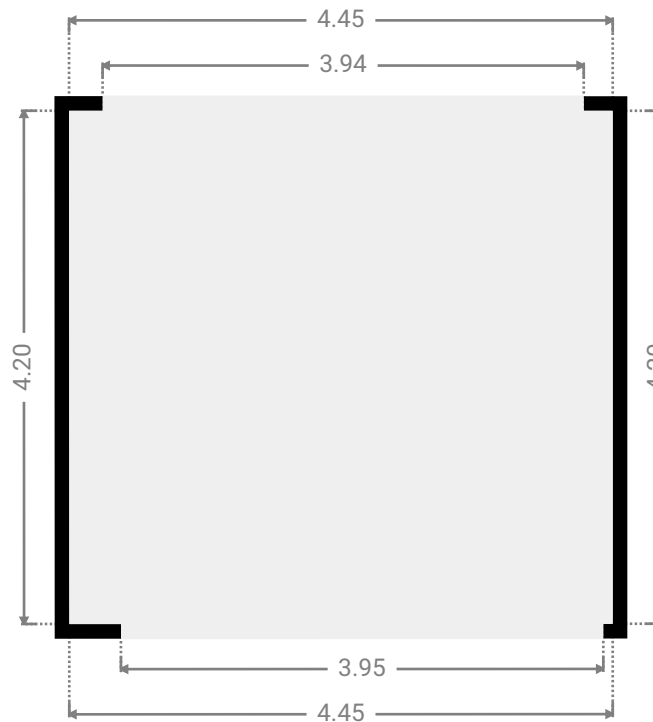
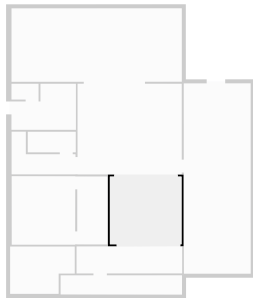

▼ Kitchen
Ground Floor

WIDTH: 6.47 m • LENGTH: 5.63 m
AREA: 36.43 m² • PERIMETER: 24.20 m

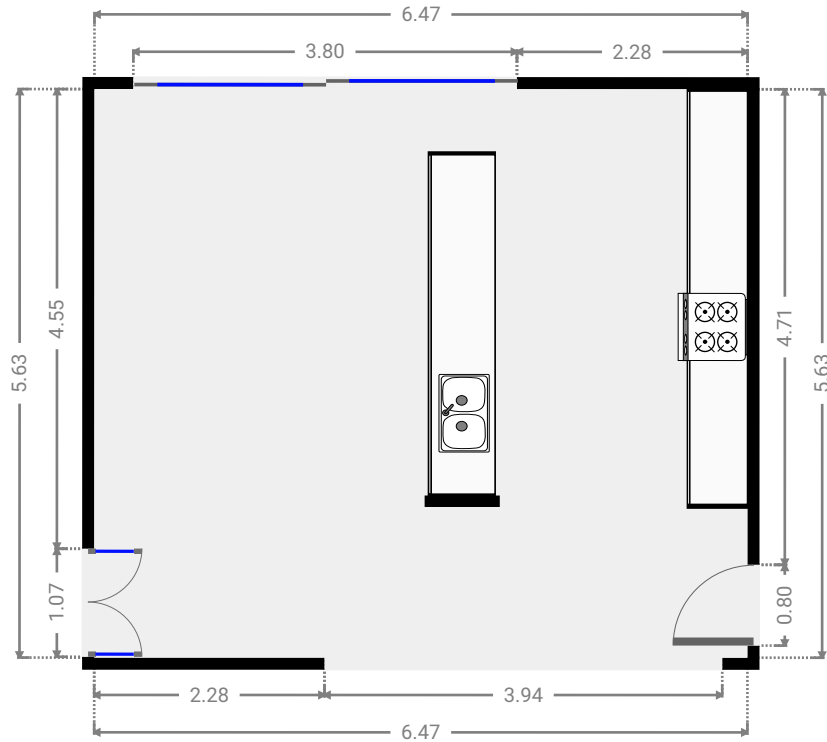
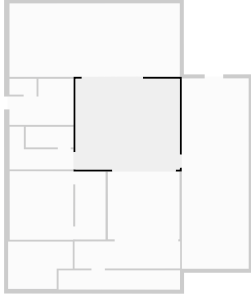

▼ Hall
Ground Floor

WIDTH: 3.97 m • LENGTH: 2.65 m
AREA: 6.19 m² • PERIMETER: 13.24 m

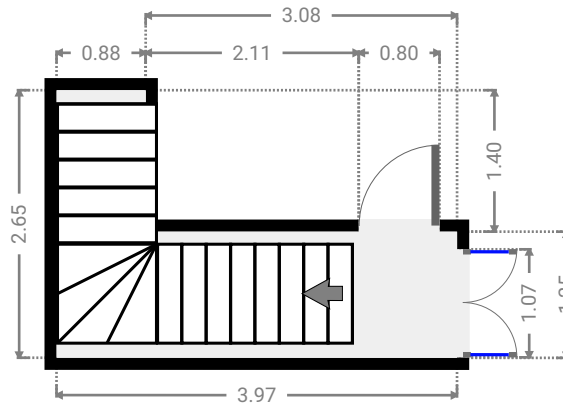
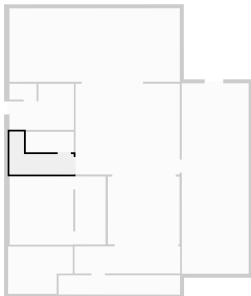

▼ Closet
Ground Floor

WIDTH: 2.98 m • LENGTH: 1.28 m
AREA: 3.80 m² • PERIMETER: 8.51 m

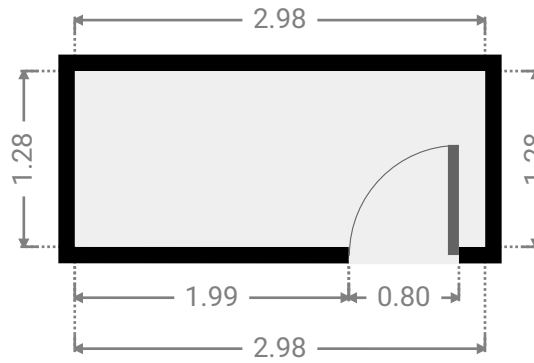
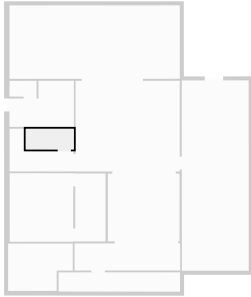

▼ Closet
Ground Floor

WIDTH: 1.88 m • LENGTH: 4.22 m
AREA: 7.93 m² • PERIMETER: 12.20 m

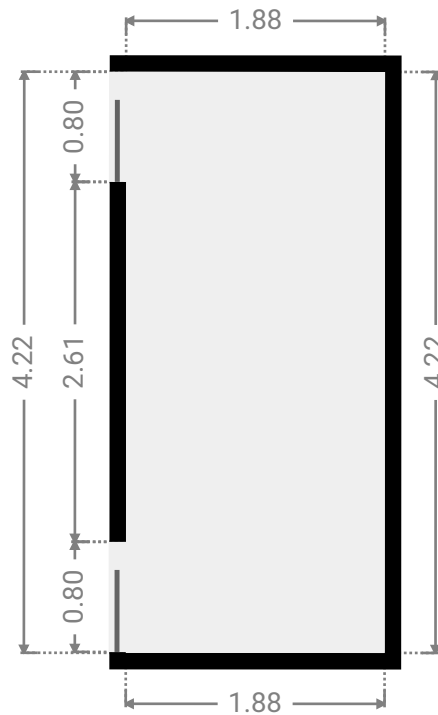
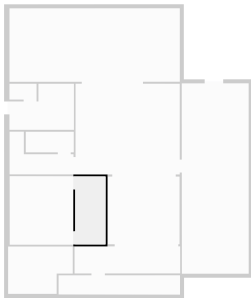

▼ **Master Bedroom**
Ground Floor

WIDTH: 3.95 m • LENGTH: 4.26 m
AREA: 16.77 m² • PERIMETER: 16.39 m

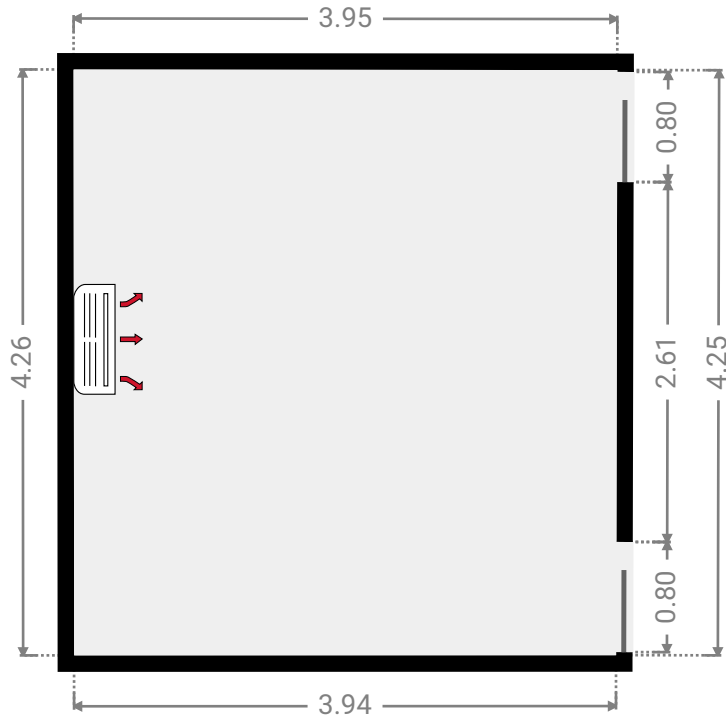
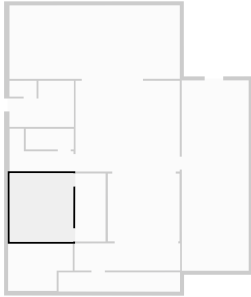

▼ **Bathroom**
Ground Floor

WIDTH: 4.01 m • LENGTH: 2.94 m
AREA: 10.52 m² • PERIMETER: 13.90 m

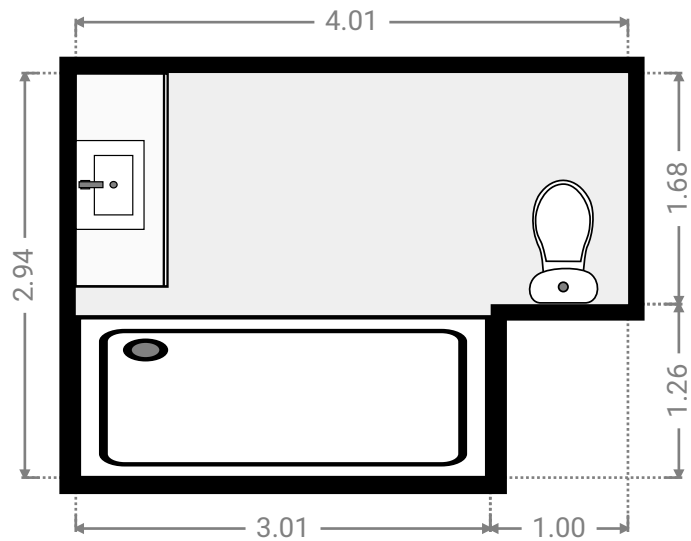
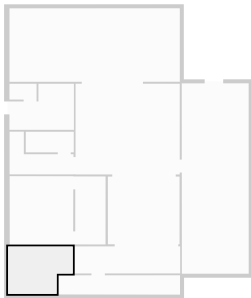

▼ Other
Ground Floor

WIDTH: 7.54 m • LENGTH: 1.20 m
AREA: 9.00 m² • PERIMETER: 17.47 m

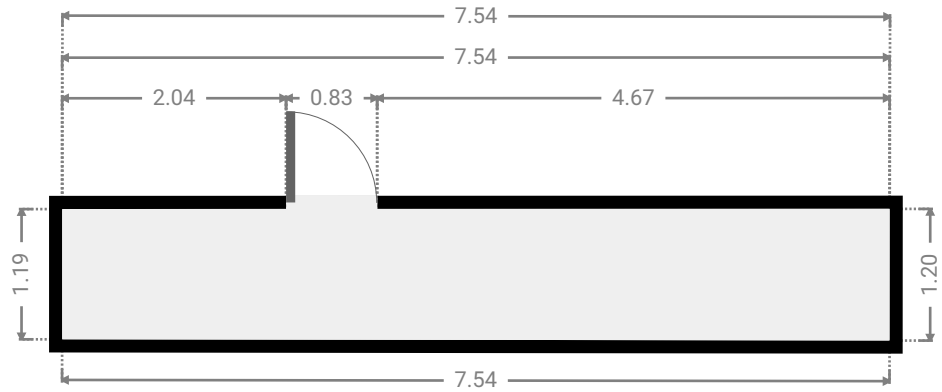
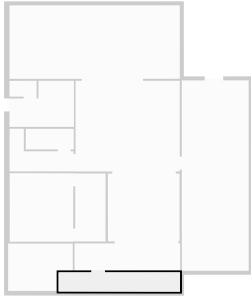

▼ Laundry Room
Ground Floor

WIDTH: 4.00 m • LENGTH: 2.86 m
AREA: 9.46 m² • PERIMETER: 13.72 m

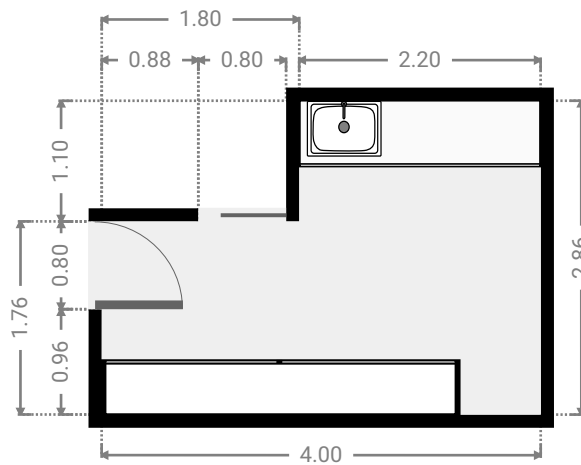
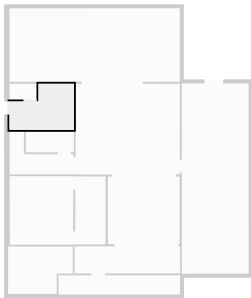

▼ **Toilet**
Ground Floor

WIDTH: 1.68 m • LENGTH: 0.98 m
AREA: 1.64 m² • PERIMETER: 5.32 m

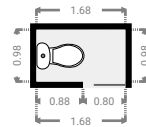
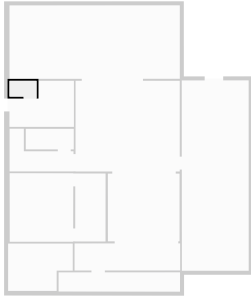

▼ **Other**
Ground Floor

WIDTH: 4.16 m • LENGTH: 11.82 m
AREA: 49.07 m² • PERIMETER: 31.94 m

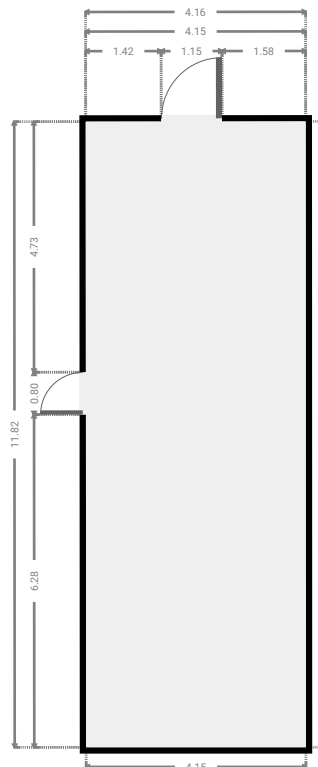
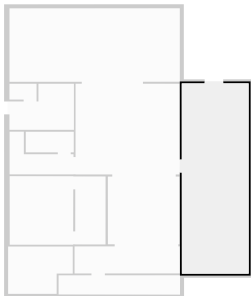

▼ Other
Ground Floor

WIDTH: 10.58 m • LENGTH: 4.56 m
AREA: 48.21 m² • PERIMETER: 30.27 m

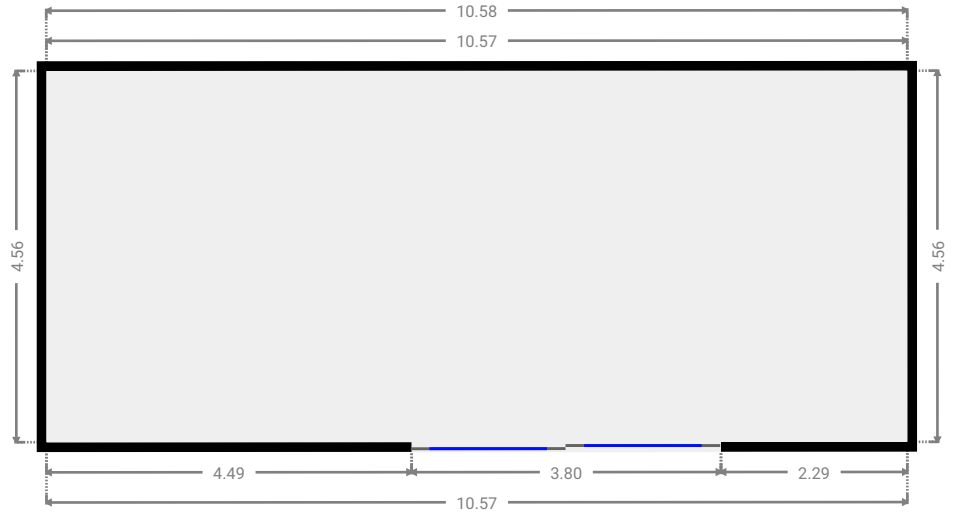
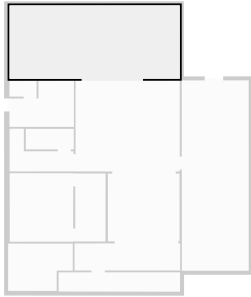

▼ 1st Floor

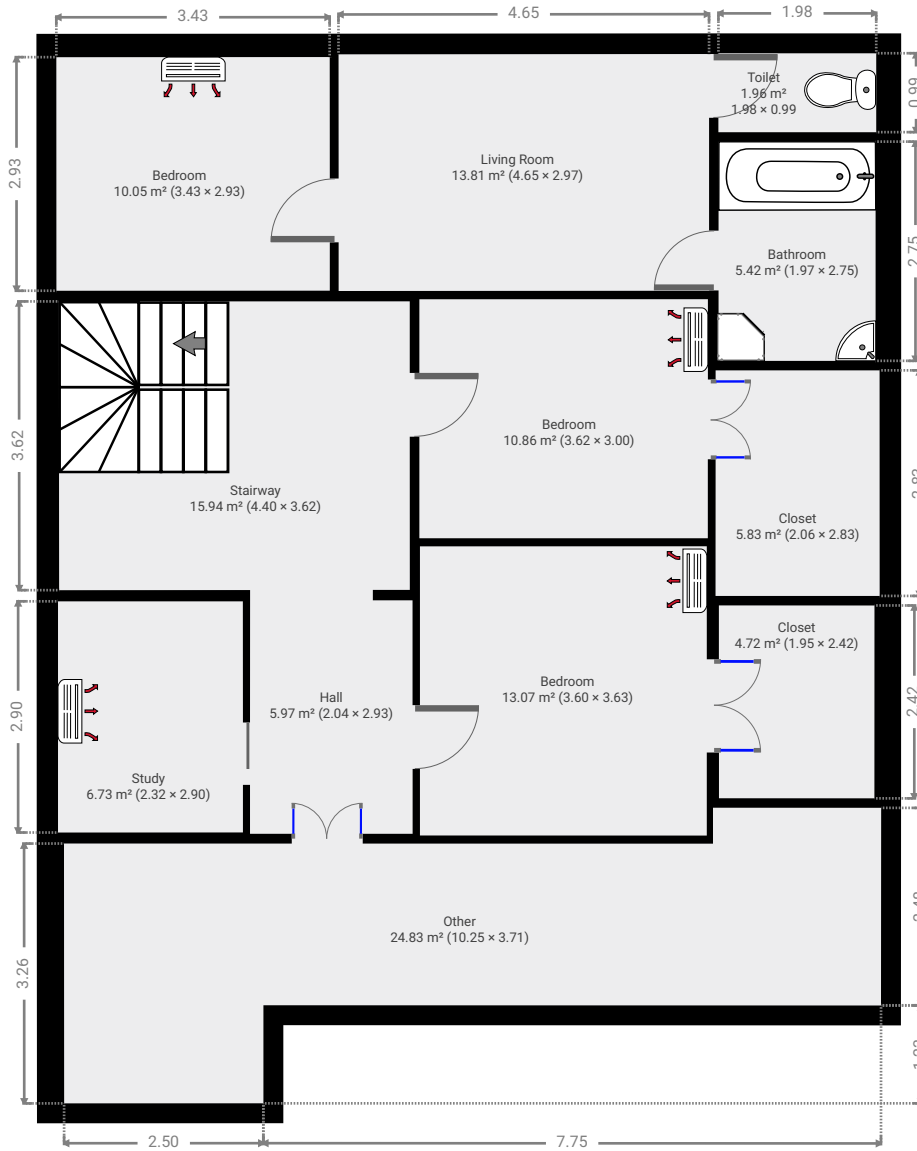

▼ Other
1st Floor

WIDTH: 10.25 m • LENGTH: 3.71 m
AREA: 24.83 m² • PERIMETER: 27.93 m

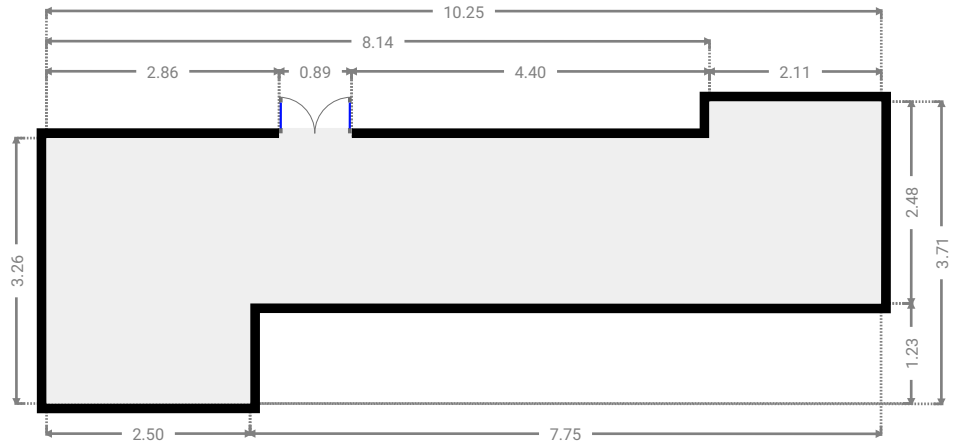
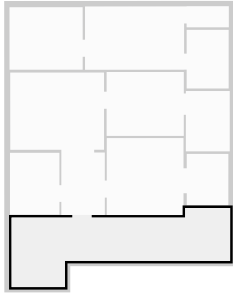

▼ Study
1st Floor

WIDTH: 2.32 m • LENGTH: 2.90 m
AREA: 6.73 m² • PERIMETER: 10.44 m

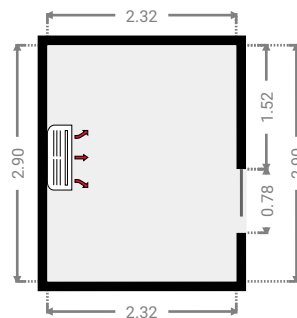
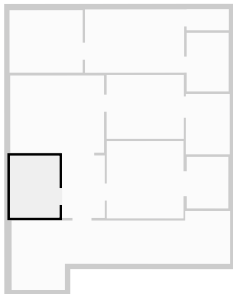

▼ **Hall**
1st Floor

WIDTH: 2.04 m • LENGTH: 2.93 m
AREA: 5.97 m² • PERIMETER: 9.94 m

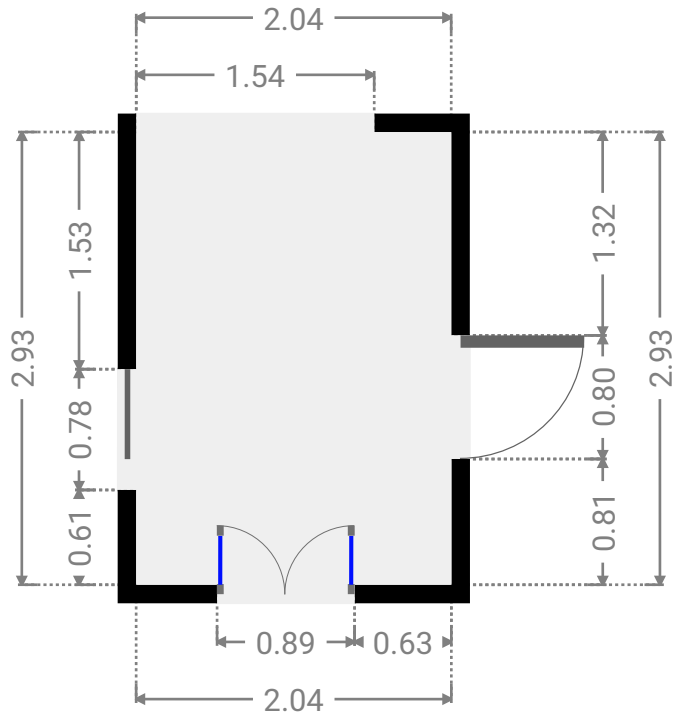
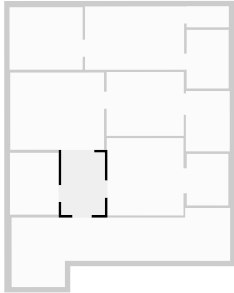

▼ **Bedroom**
1st Floor

WIDTH: 3.60 m • LENGTH: 3.63 m
AREA: 13.07 m² • PERIMETER: 14.46 m

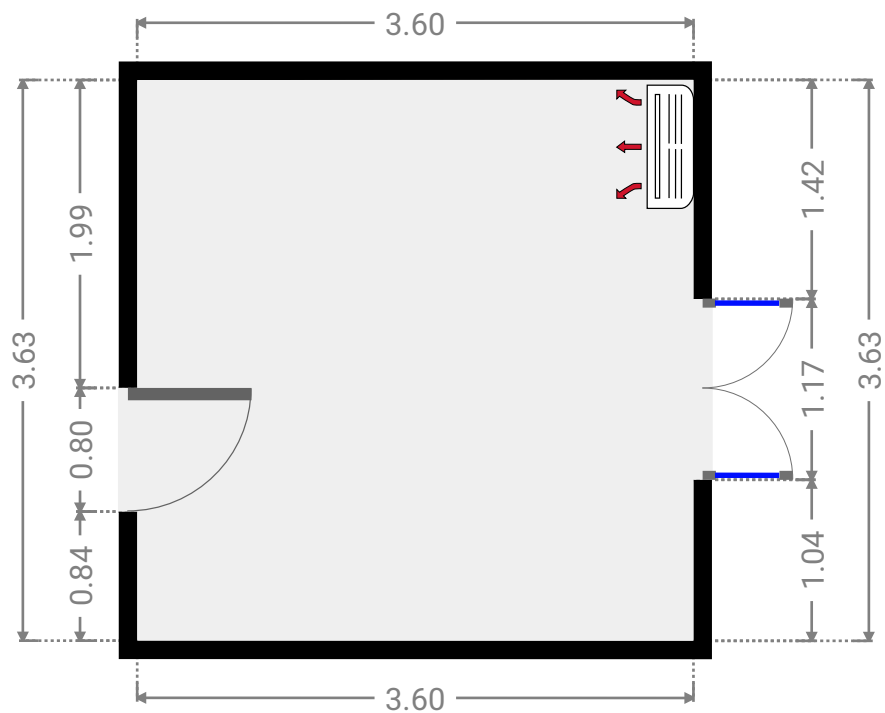
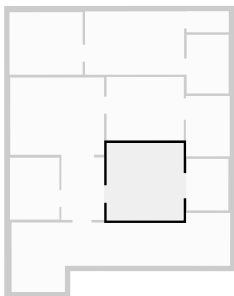

▼ **Closet**
1st Floor

WIDTH: 1.95 m • LENGTH: 2.42 m
AREA: 4.72 m² • PERIMETER: 8.74 m

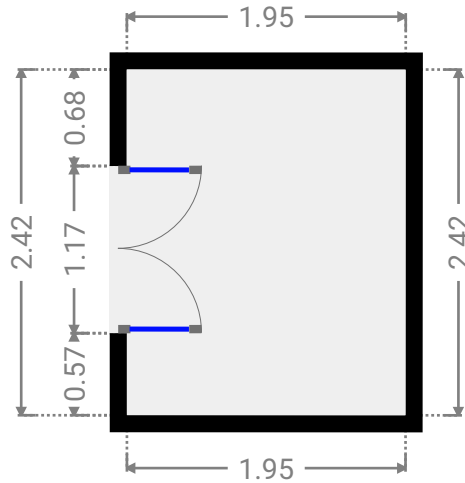
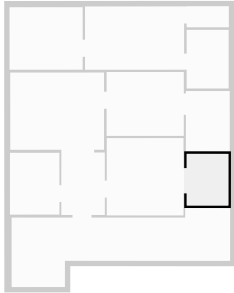

▼ **Stairway**
1st Floor

WIDTH: 4.40 m • LENGTH: 3.62 m
AREA: 15.94 m² • PERIMETER: 16.04 m

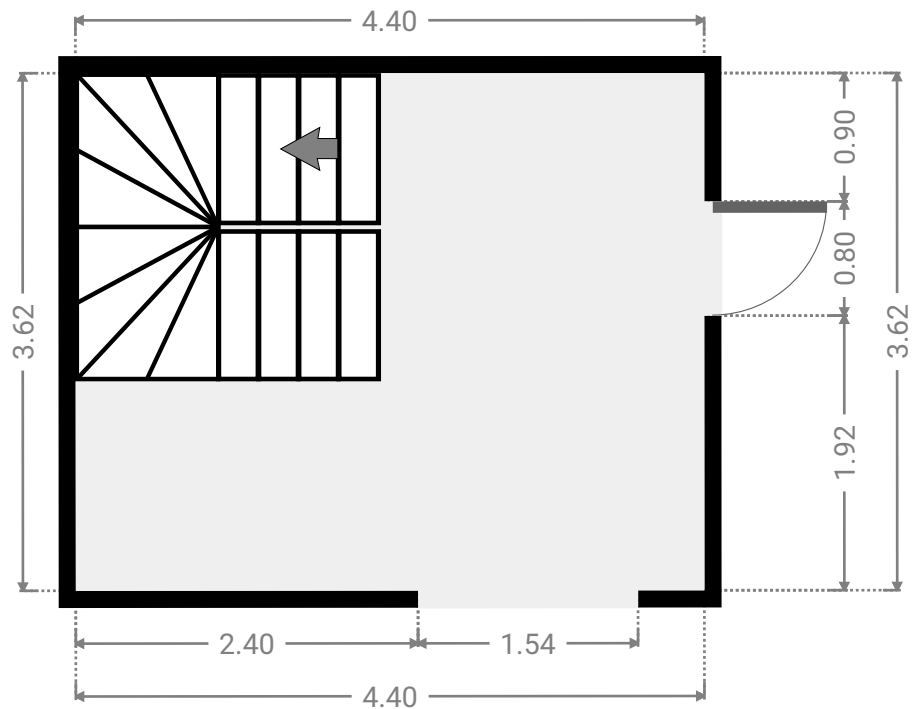
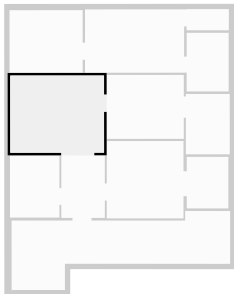

▼ **Bedroom**
1st Floor

WIDTH: 3.62 m • LENGTH: 3.00 m
AREA: 10.86 m² • PERIMETER: 13.24 m

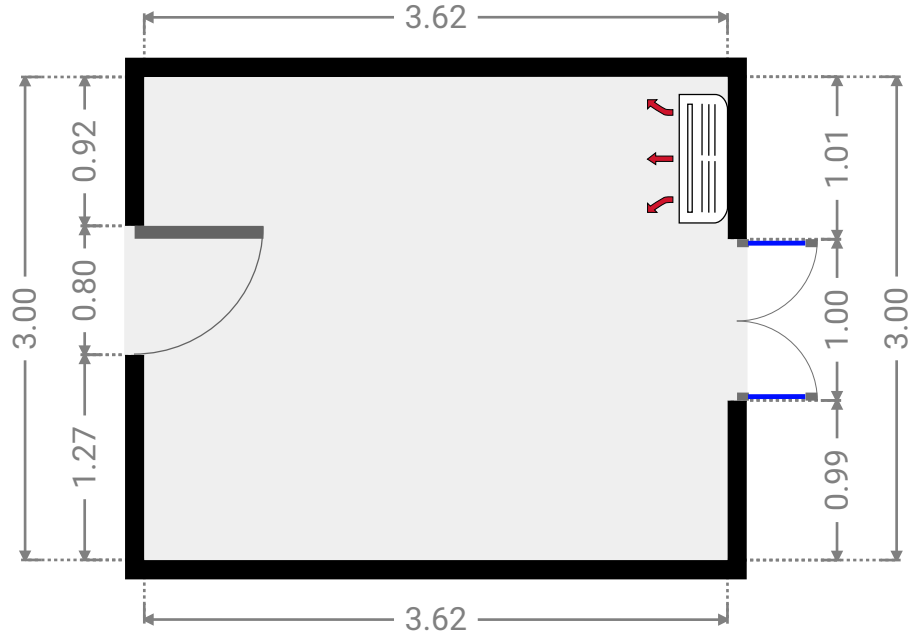
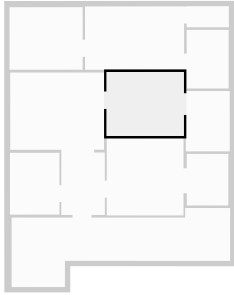

▼ **Closet**
1st Floor

WIDTH: 2.06 m • LENGTH: 2.83 m
AREA: 5.83 m² • PERIMETER: 9.78 m

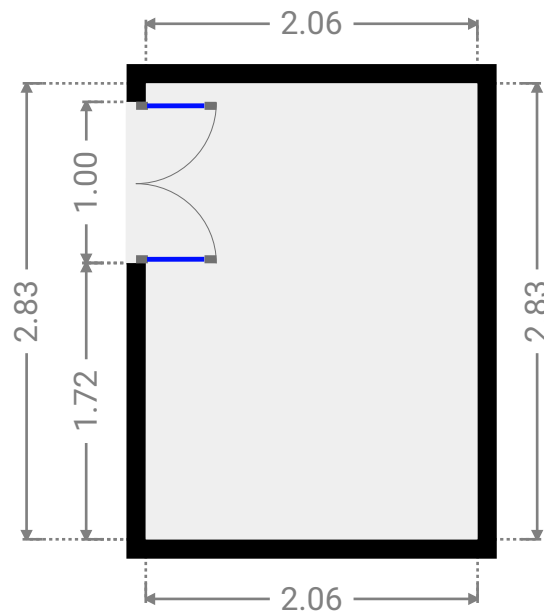
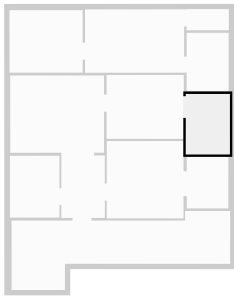

▼ **Bathroom**
1st Floor

WIDTH: 1.97 m • LENGTH: 2.75 m
AREA: 5.42 m² • PERIMETER: 9.44 m

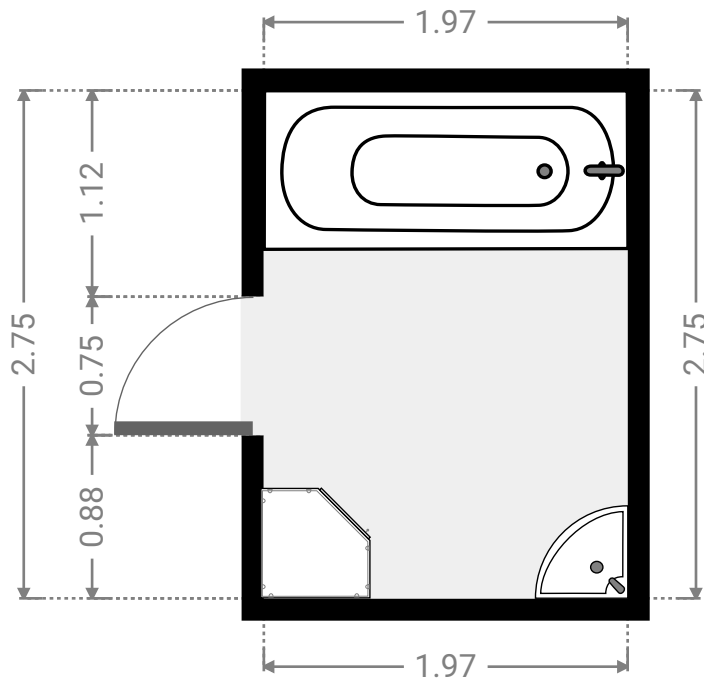
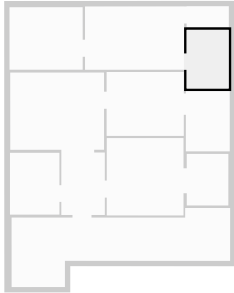

▼ **Toilet**
1st Floor

WIDTH: 1.98 m • LENGTH: 0.99 m
AREA: 1.96 m² • PERIMETER: 5.94 m

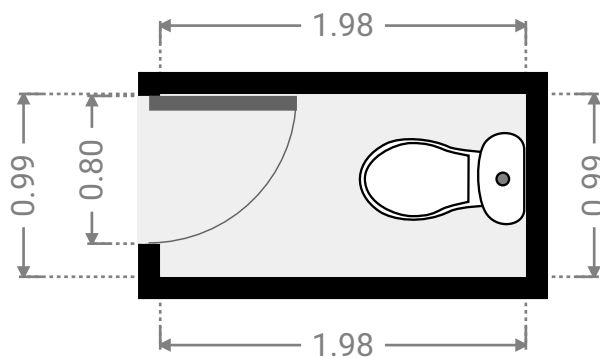
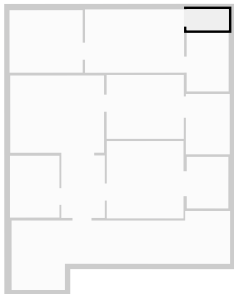

▼ Living Room
1st Floor

WIDTH: 4.65 m • LENGTH: 2.97 m
AREA: 13.81 m² • PERIMETER: 15.24 m

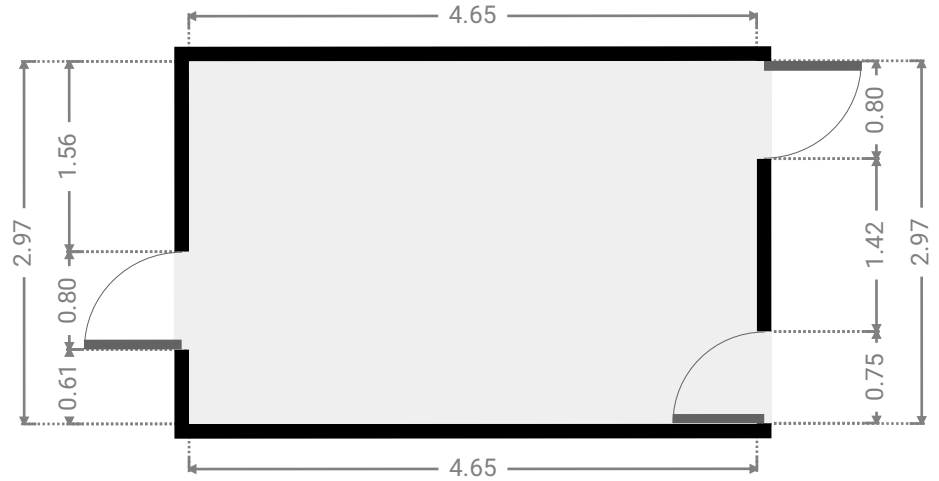
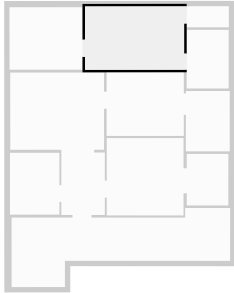

▼ Bedroom
1st Floor

WIDTH: 3.43 m • LENGTH: 2.93 m
AREA: 10.05 m² • PERIMETER: 12.72 m

