

18 Frangipani Court

SUBMITTED BY

Ray White Rockhampton Casey
stockers@cqoz.com

CREATED ON

2021-11-11

Floors

1

▼ Ground Floor



▼ Bedroom Ground Floor

WIDTH: 4.18 m • LENGTH: 3.00 m
AREA: 12.54 m² • PERIMETER: 14.36 m

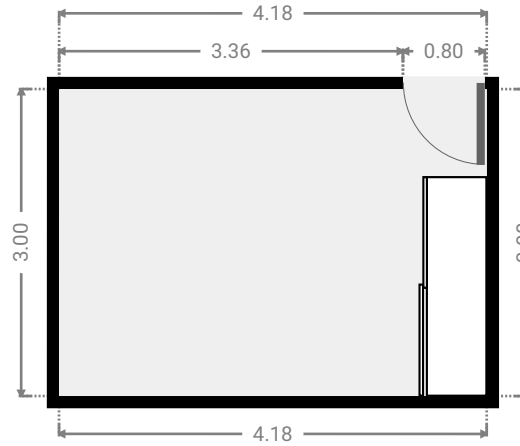
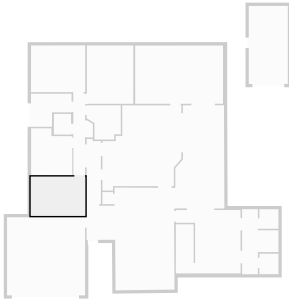

▼ Garage Ground Floor

WIDTH: 6.00 m • LENGTH: 6.00 m
AREA: 36.00 m² • PERIMETER: 24.00 m

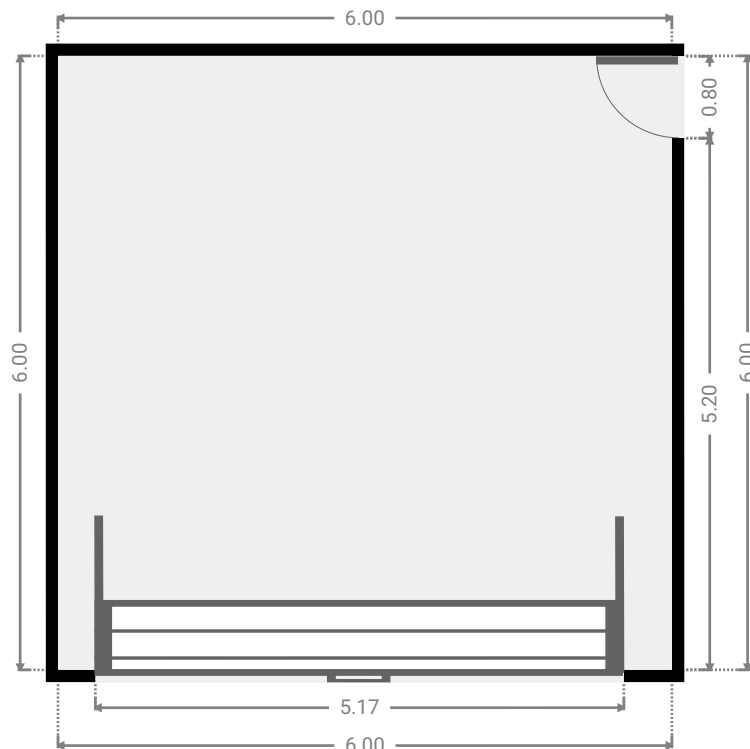
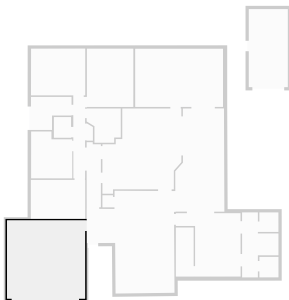

18 Frangipani Court

FLOORS: 1



▼ Other Ground Floor

WIDTH: 3.00 m • LENGTH: 6.00 m
AREA: 18.00 m² • PERIMETER: 18.00 m

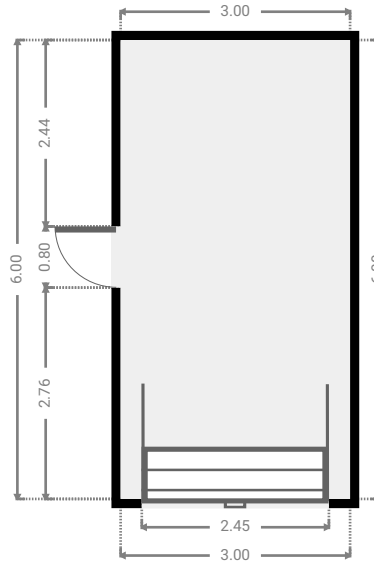
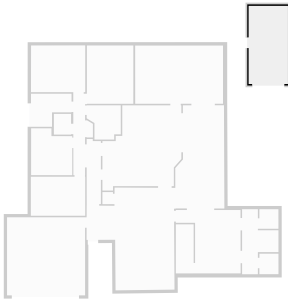

▼ Other Ground Floor

WIDTH: 3.78 m • LENGTH: 7.94 m
AREA: 27.16 m² • PERIMETER: 23.01 m

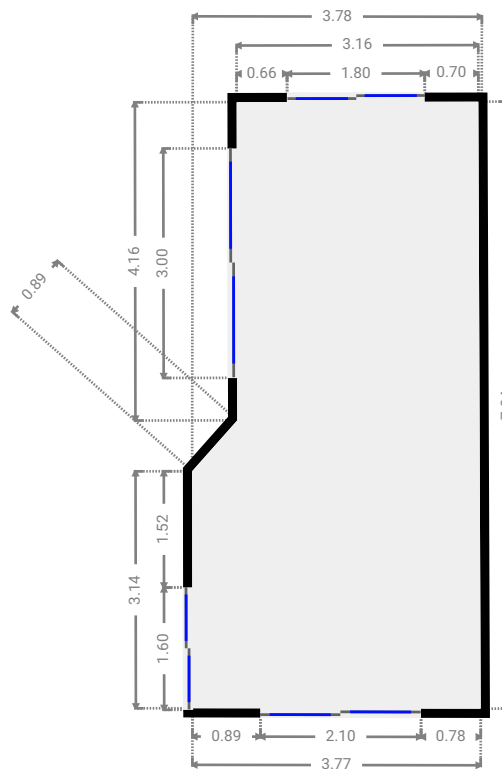
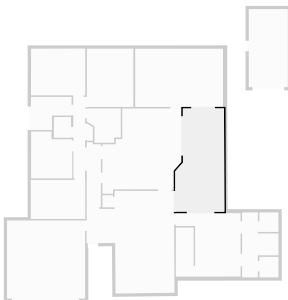

THIS FLOORPLAN IS PROVIDED WITHOUT WARRANTY OF ANY KIND. SENSOPIA DISCLAIMS ANY WARRANTY INCLUDING, WITHOUT LIMITATION, SATISFACTORY QUALITY OR ACCURACY OF DIMENSIONS.

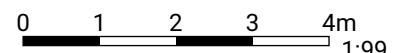

FLOORS: 1

▼ Closet Ground Floor

WIDTH: 0.48 m • LENGTH: 1.33 m
AREA: 0.57 m² • PERIMETER: 3.42 m

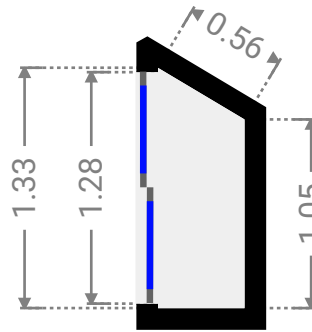
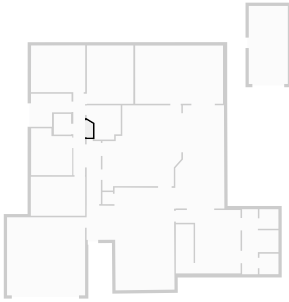

▼ Bathroom Ground Floor

WIDTH: 2.62 m • LENGTH: 2.63 m
AREA: 5.82 m² • PERIMETER: 10.24 m

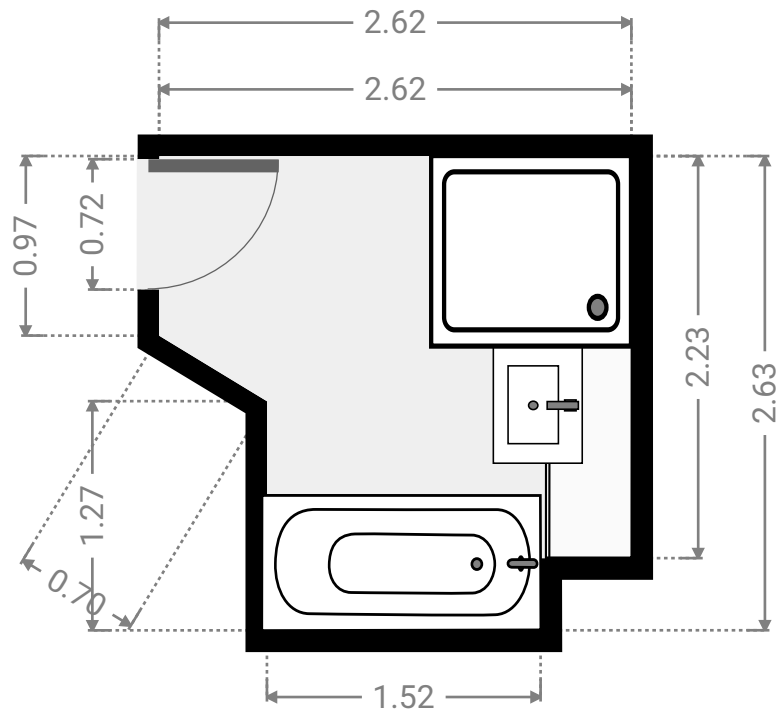
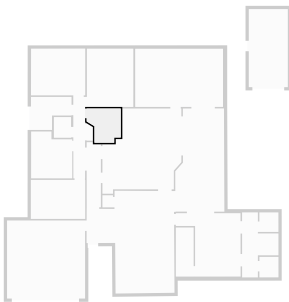

FLOORS: 1

▼ Bedroom Ground Floor

WIDTH: 4.17 m • LENGTH: 3.60 m
AREA: 14.97 m² • PERIMETER: 15.52 m

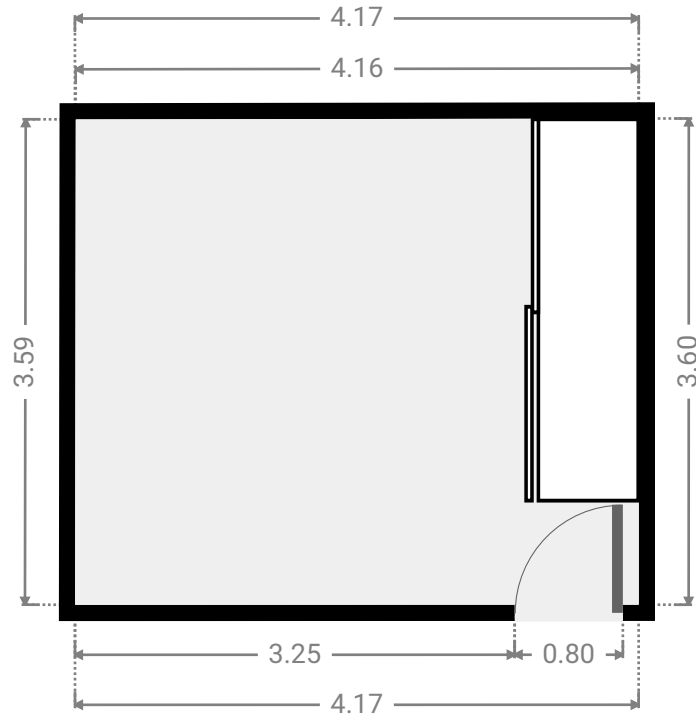
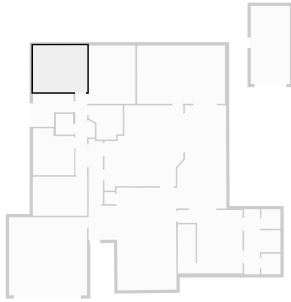

▼ Bedroom Ground Floor

WIDTH: 3.57 m • LENGTH: 4.48 m
AREA: 16.00 m² • PERIMETER: 16.10 m

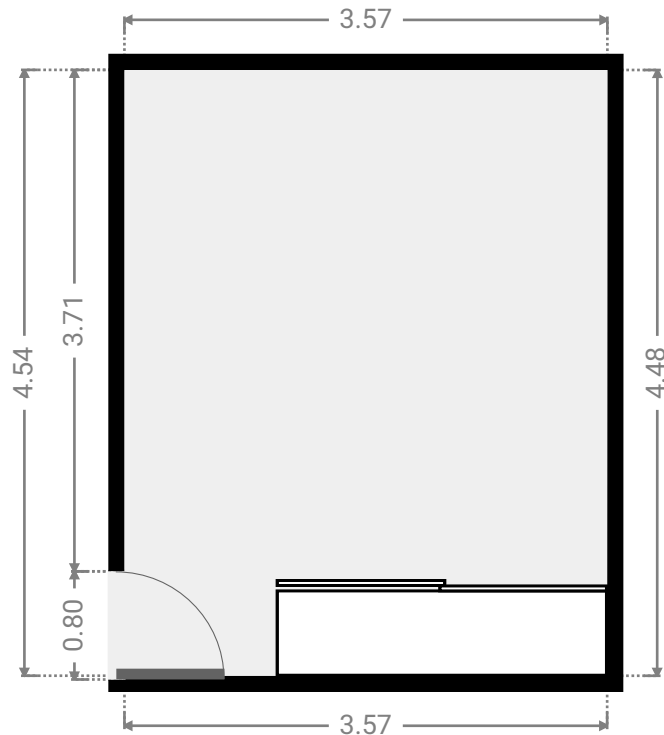
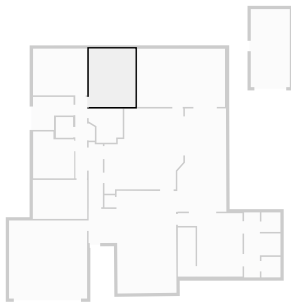

FLOORS: 1

▼ **Laundry Room**
Ground Floor

WIDTH: 3.12 m • LENGTH: 2.54 m
AREA: 6.25 m² • PERIMETER: 11.31 m

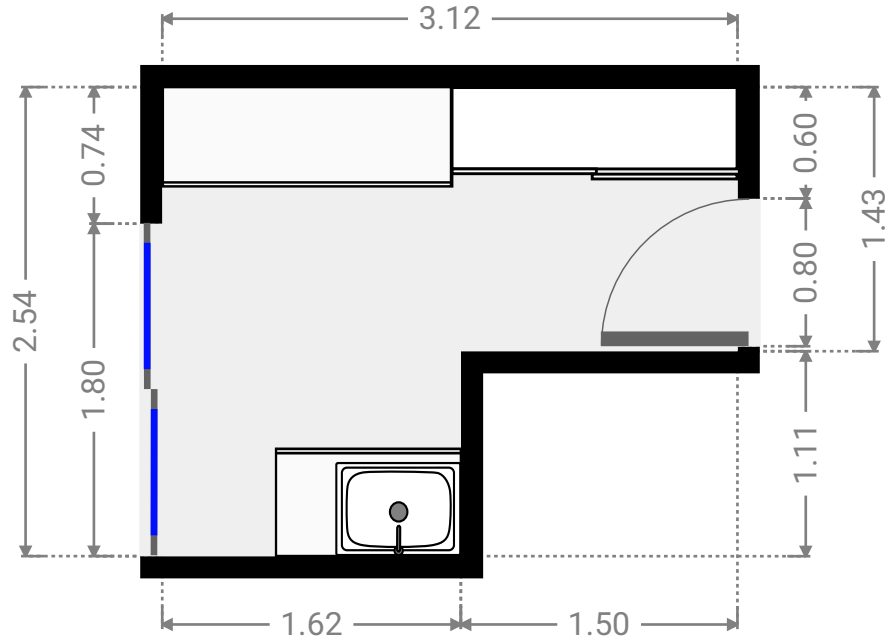
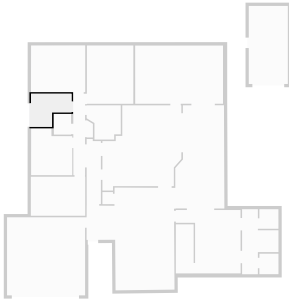

▼ **Toilet**
Ground Floor

WIDTH: 1.32 m • LENGTH: 1.59 m
AREA: 2.10 m² • PERIMETER: 5.82 m

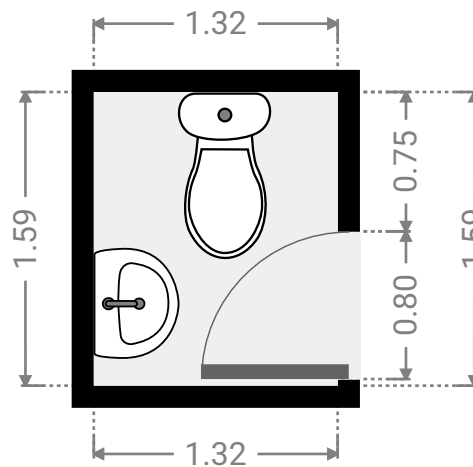
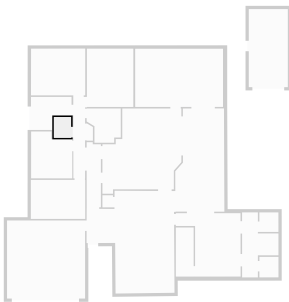

FLOORS: 1

▼ Bedroom Ground Floor

WIDTH: 3.16 m • LENGTH: 3.60 m
AREA: 10.42 m² • PERIMETER: 13.52 m

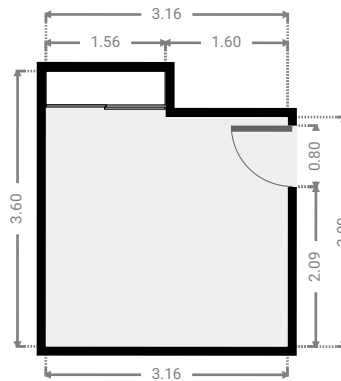
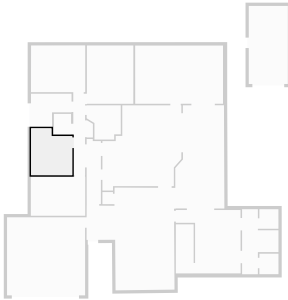

▼ Living Room Ground Floor

WIDTH: 6.77 m • LENGTH: 7.90 m
AREA: 41.46 m² • PERIMETER: 29.18 m

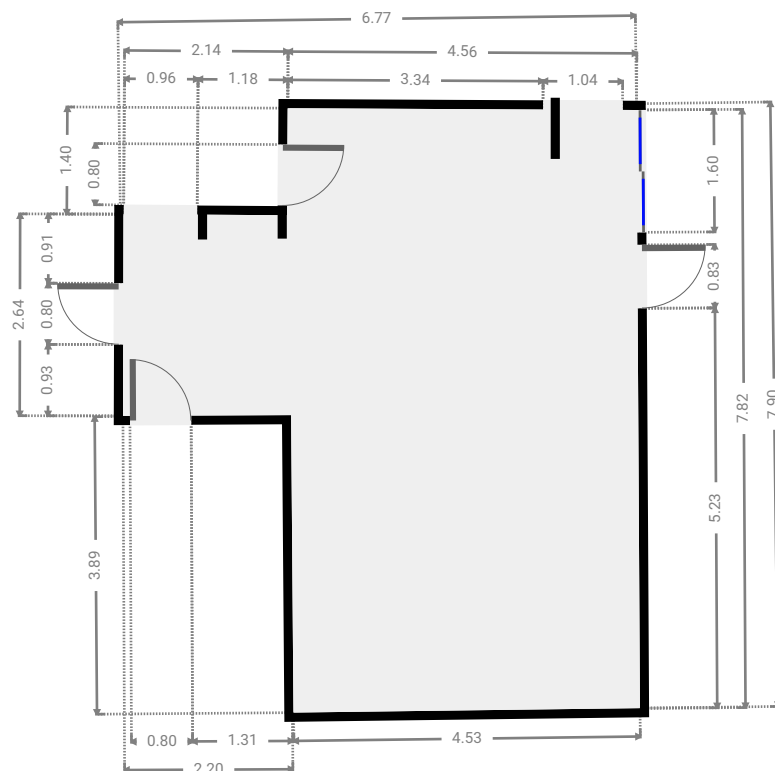
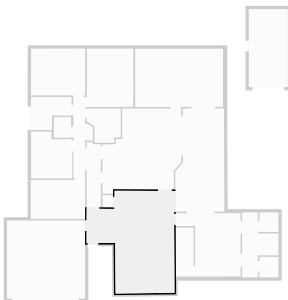

FLOORS: 1

▼ **Hall**
Ground Floor

WIDTH: 0.91 m • LENGTH: 6.26 m
AREA: 5.66 m² • PERIMETER: 14.33 m

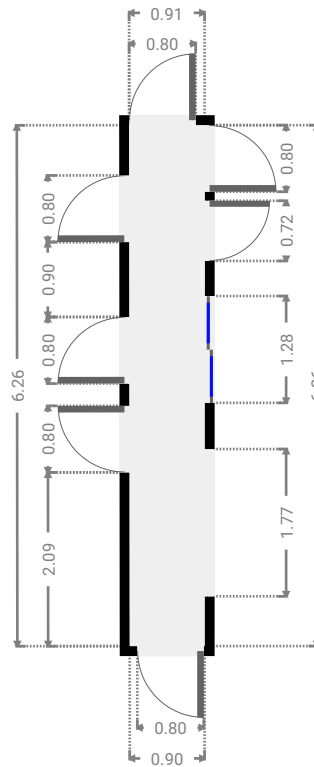

▼ **Living Room**
Ground Floor

WIDTH: 6.75 m • LENGTH: 4.47 m
AREA: 30.18 m² • PERIMETER: 22.44 m

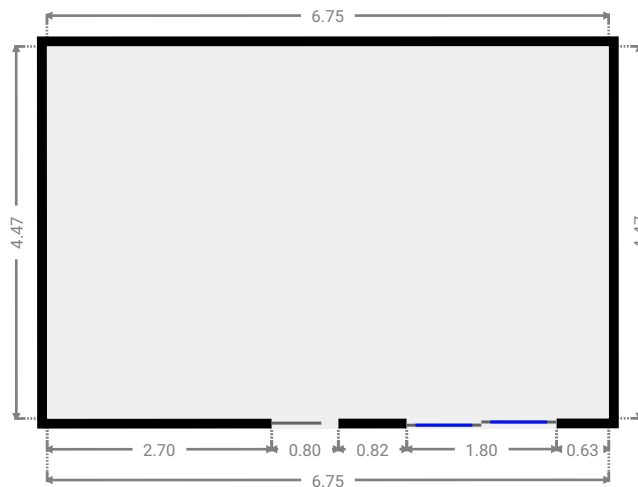
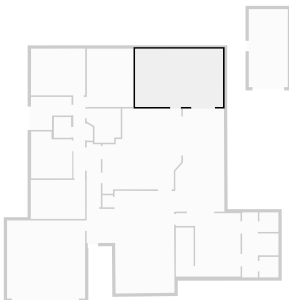

FLOORS: 1

▼ Hall Ground Floor

WIDTH: 1.09 m • LENGTH: 5.00 m
AREA: 5.36 m² • PERIMETER: 12.18 m

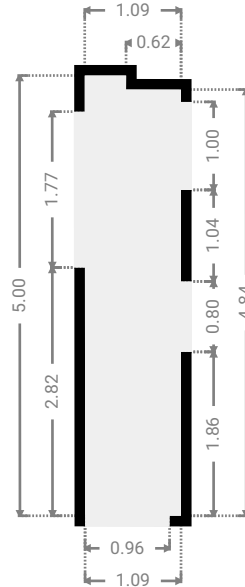
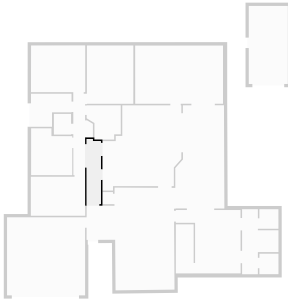

▼ Kitchen Ground Floor

WIDTH: 6.07 m • LENGTH: 6.55 m
AREA: 32.94 m² • PERIMETER: 24.87 m

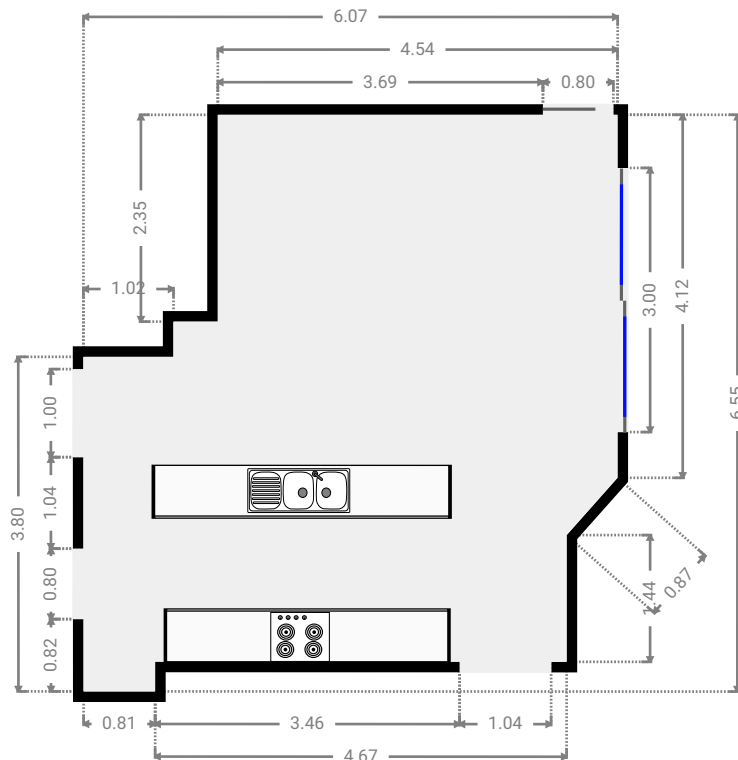
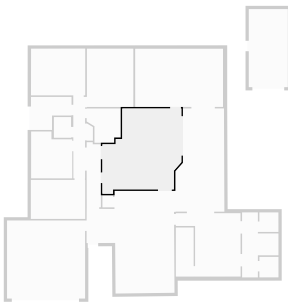

FLOORS: 1

▼ Closet
Ground Floor

WIDTH: 0.81 m • LENGTH: 0.93 m
AREA: 0.75 m² • PERIMETER: 3.48 m

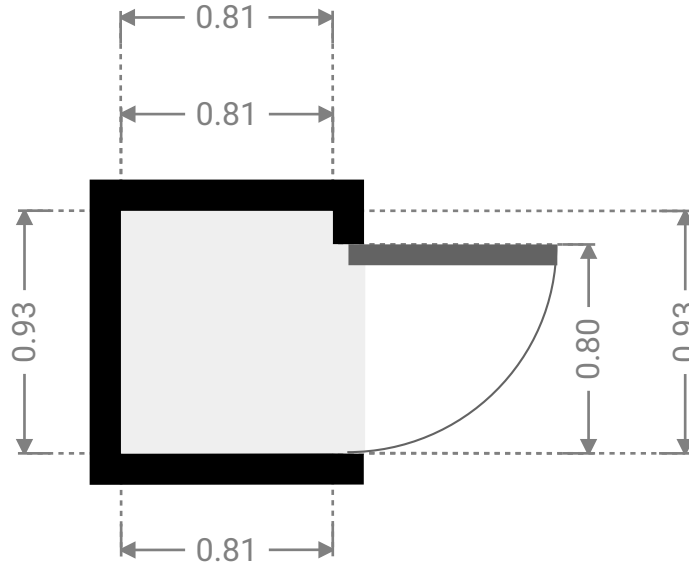
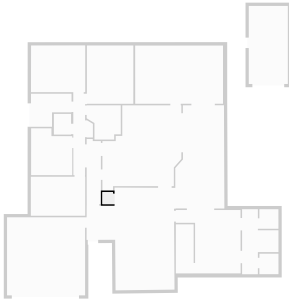

▼ Closet
Ground Floor

WIDTH: 1.46 m • LENGTH: 1.57 m
AREA: 2.30 m² • PERIMETER: 6.07 m

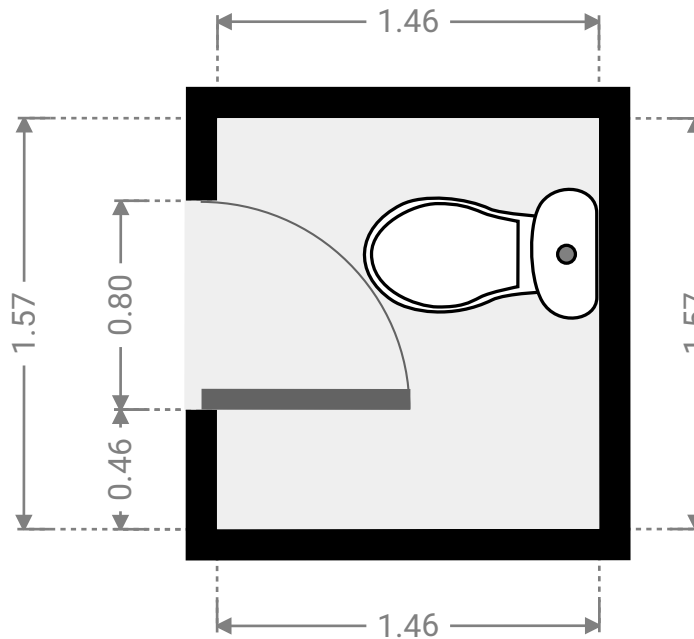
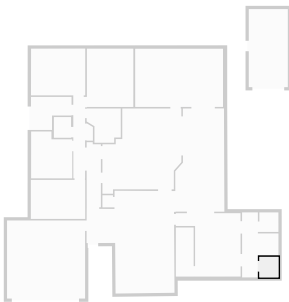

FLOORS: 1

▼ Other Ground Floor

WIDTH: 1.46 m • LENGTH: 1.50 m
AREA: 2.19 m² • PERIMETER: 5.92 m

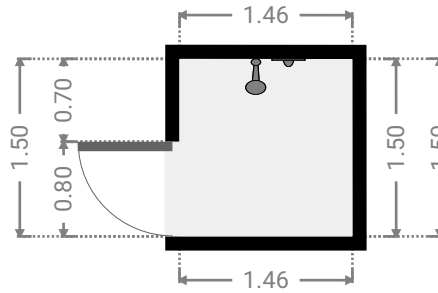
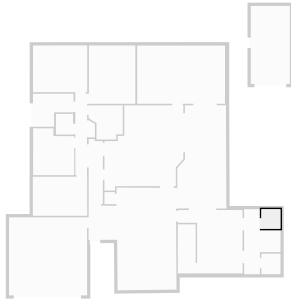

▼ Bathroom Ground Floor

WIDTH: 2.79 m • LENGTH: 5.00 m
AREA: 8.71 m² • PERIMETER: 15.58 m

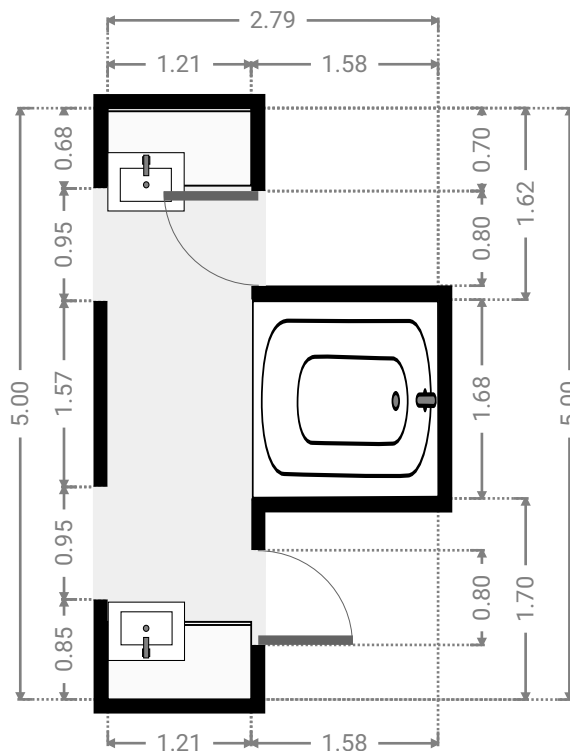
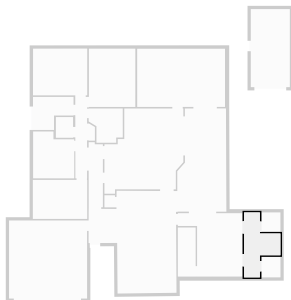

FLOORS: 1

▼ Closet Ground Floor

WIDTH: 1.37 m • LENGTH: 3.77 m
AREA: 5.16 m² • PERIMETER: 10.28 m

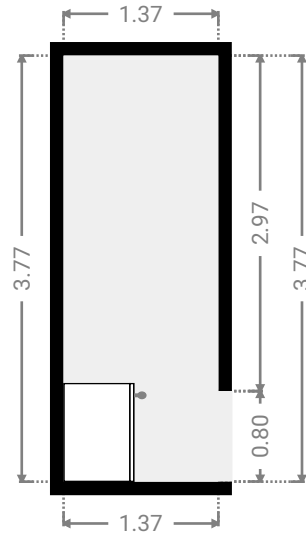
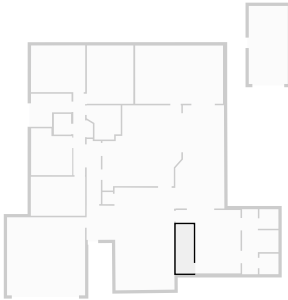

▼ Master Bedroom Ground Floor

WIDTH: 4.97 m • LENGTH: 4.88 m
AREA: 18.48 m² • PERIMETER: 19.69 m

