

18 Elgin Street

SUBMITTED BY
Janelle Casey

CREATED ON
2021-10-14

Floors
2

▼ Ground Floor

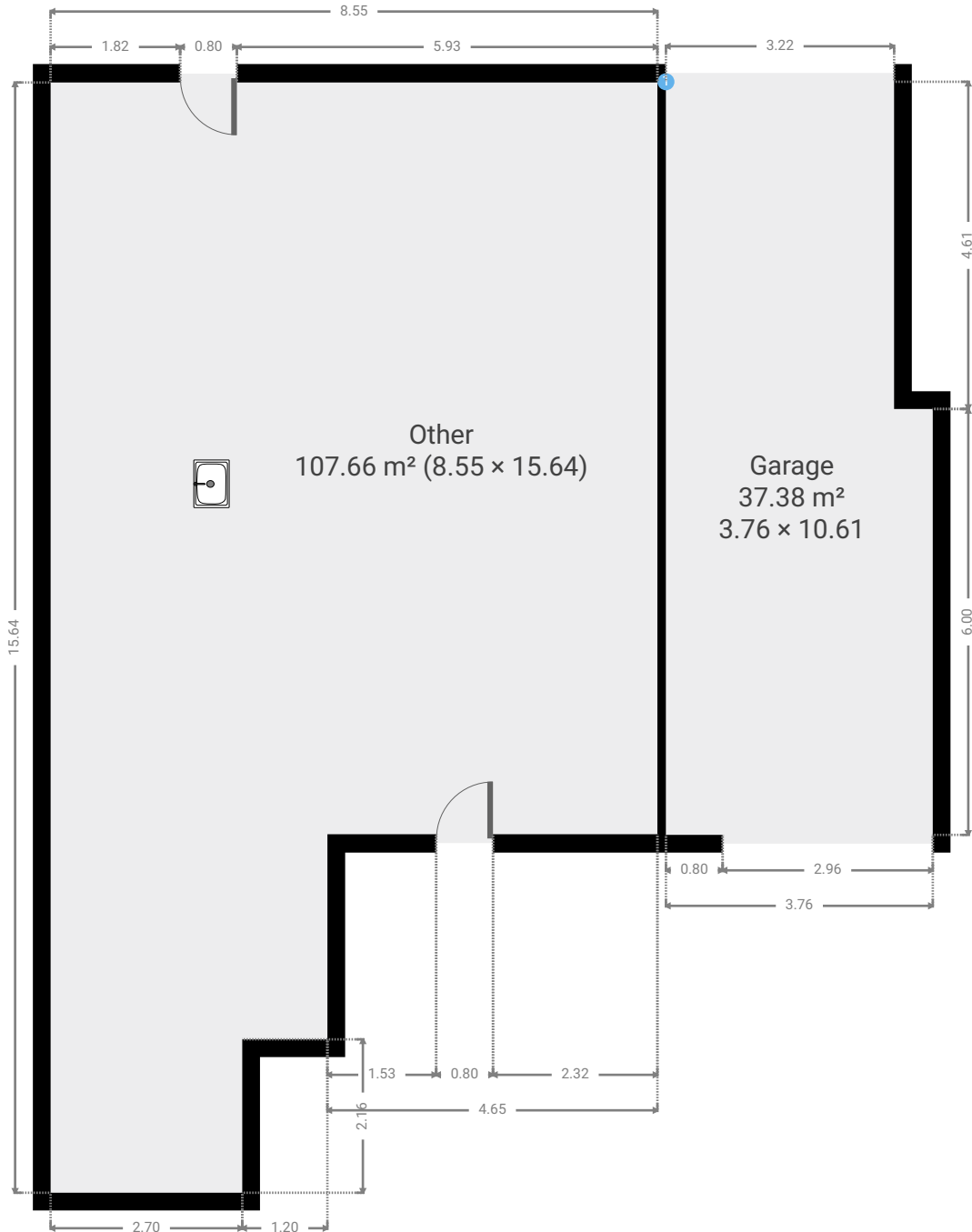

▼ **Other**
Ground Floor

WIDTH: 8.55 m • LENGTH: 15.64 m
AREA: 107.66 m² • PERIMETER: 48.39 m

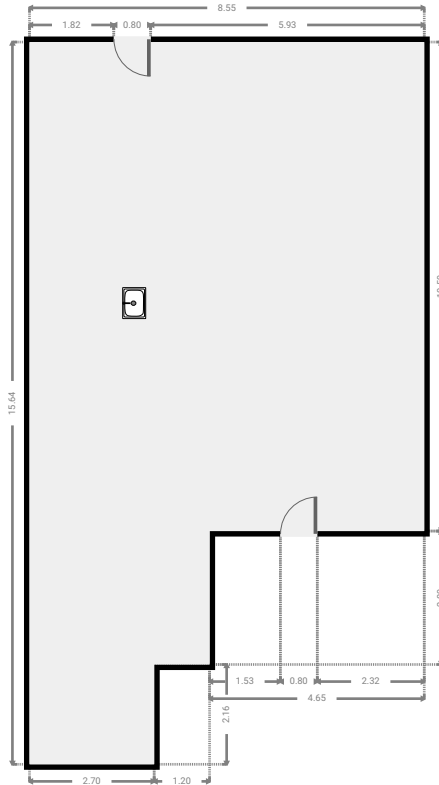
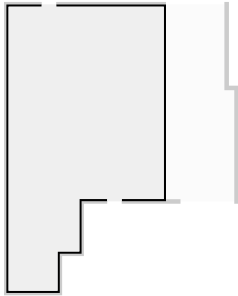

▼ **Garage**
Ground Floor

WIDTH: 3.76 m • LENGTH: 10.61 m
AREA: 37.38 m² • PERIMETER: 28.74 m

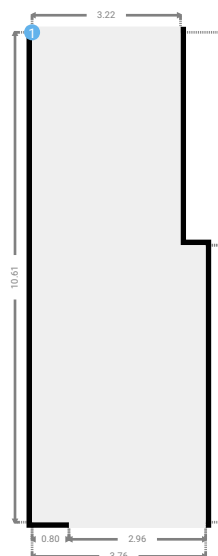
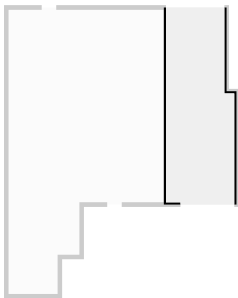

▼ Garage/Ground Floor

1 OPENING

Height
0.00 m



▼ 1st Floor

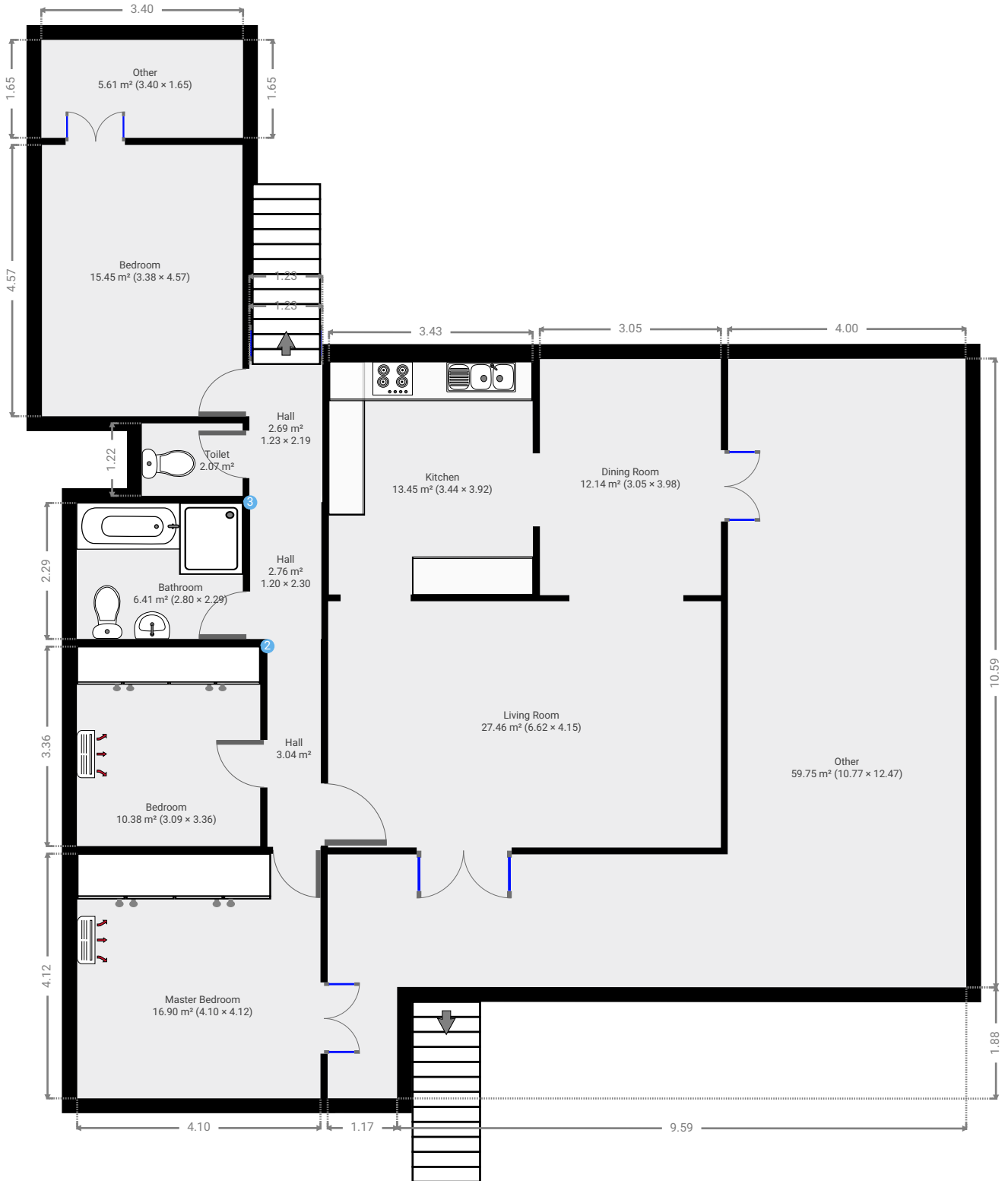

▼ Master Bedroom
1st Floor

WIDTH: 4.10 m • LENGTH: 4.12 m
AREA: 16.90 m² • PERIMETER: 16.44 m

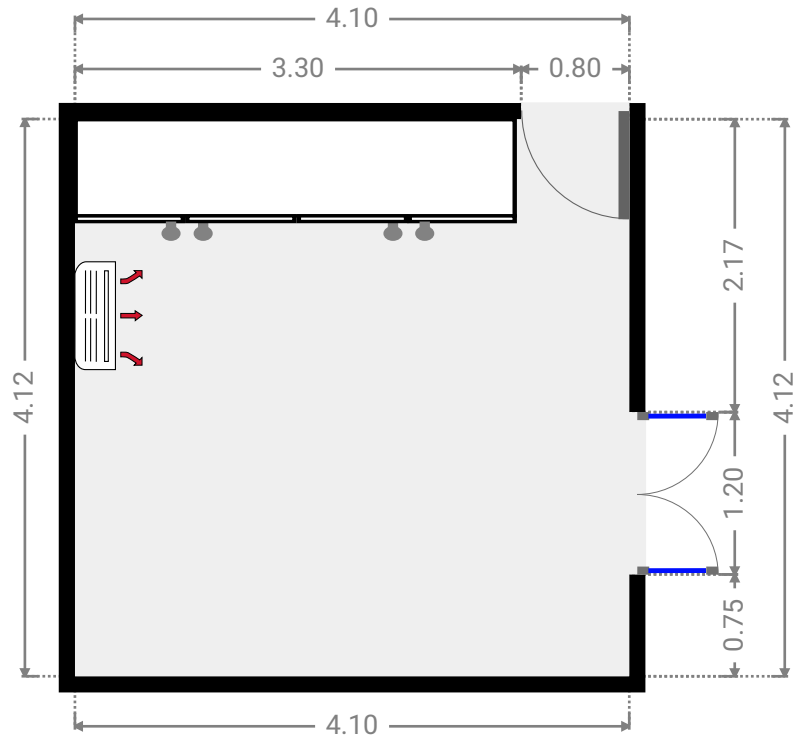
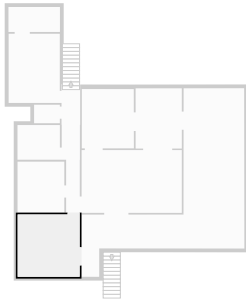

▼ Hall
1st Floor

WIDTH: 0.90 m • LENGTH: 3.38 m
AREA: 3.04 m² • PERIMETER: 8.56 m

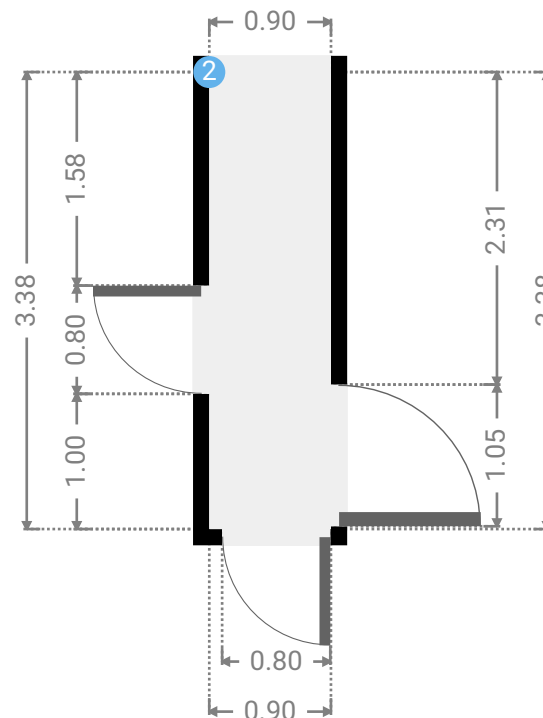

▼ **Hall/1st Floor**

2 **OPENING**

Height
0.00 m



▼ **Bedroom**
1st Floor

WIDTH: 3.09 m • LENGTH: 3.36 m
AREA: 10.38 m² • PERIMETER: 12.90 m

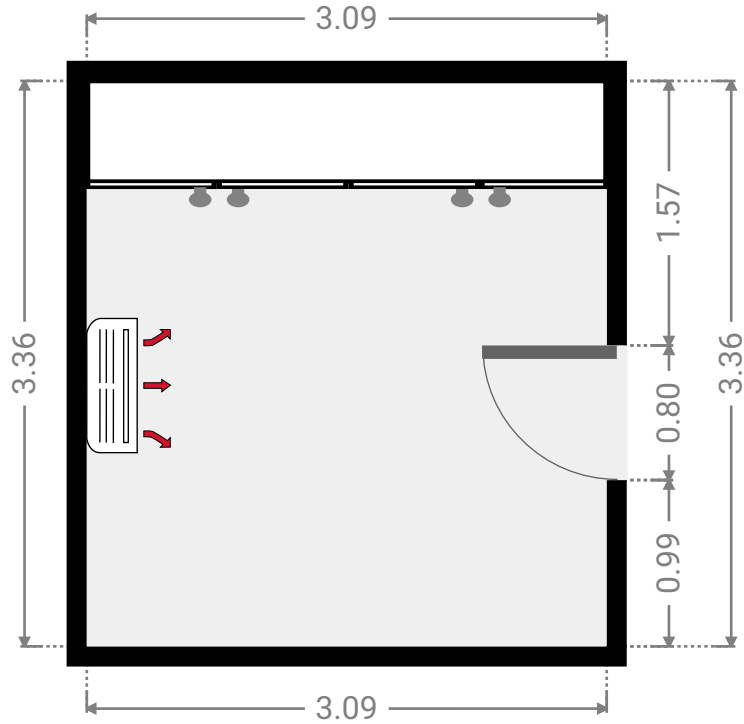
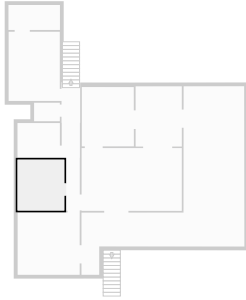

▼ **Hall**
1st Floor

WIDTH: 1.20 m • LENGTH: 2.30 m
AREA: 2.76 m² • PERIMETER: 7.00 m

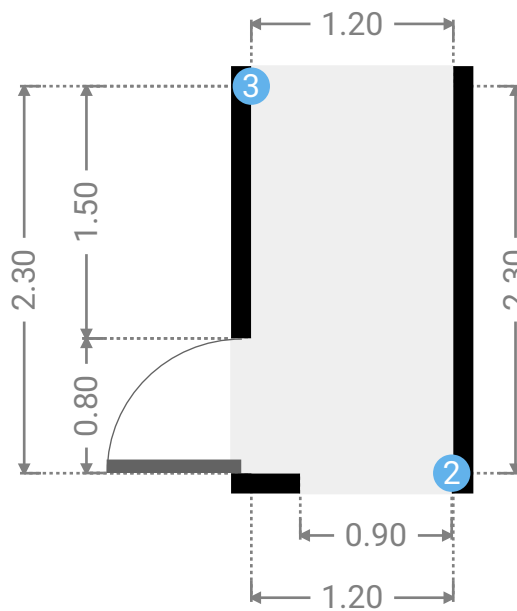

▼ **Hall/1st Floor**

3 OPENING

Height
0.00 m



▼ **Bathroom**
1st Floor

WIDTH: 2.80 m • LENGTH: 2.29 m
AREA: 6.41 m² • PERIMETER: 10.18 m

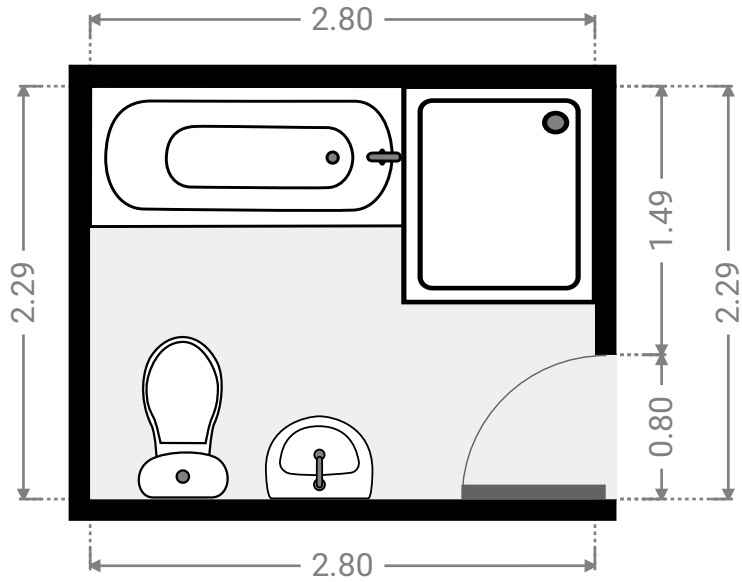
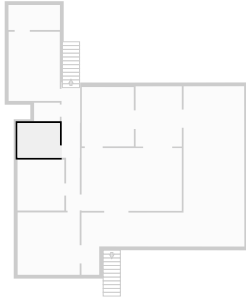

▼ **Hall**
1st Floor

WIDTH: 1.23 m • LENGTH: 2.19 m
AREA: 2.69 m² • PERIMETER: 6.84 m

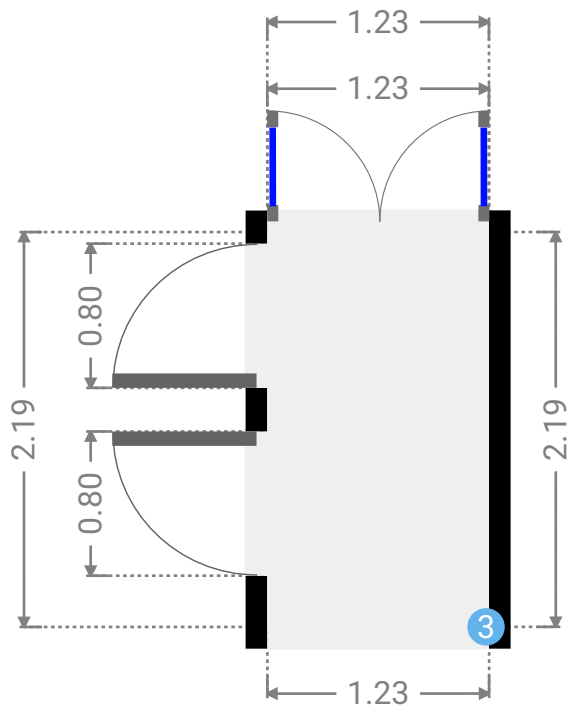

▼ **Toilet**
1st Floor

WIDTH: 1.70 m • LENGTH: 1.22 m
AREA: 2.07 m² • PERIMETER: 5.84 m

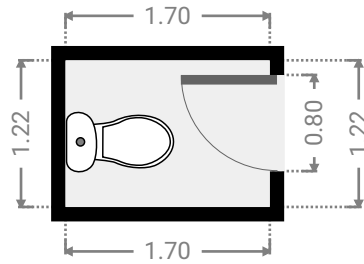
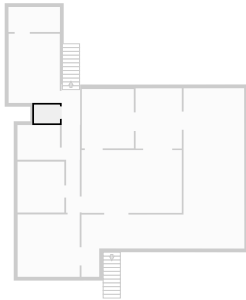

▼ **Bedroom**
1st Floor

WIDTH: 3.38 m • LENGTH: 4.57 m
AREA: 15.45 m² • PERIMETER: 15.90 m

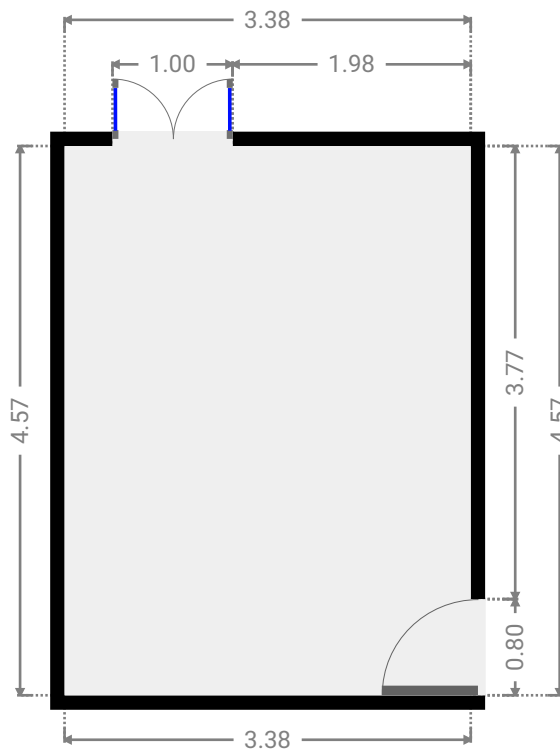
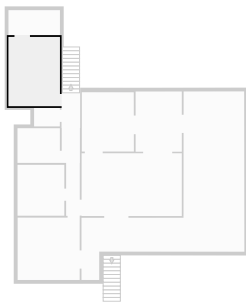

▼ Other
1st Floor

WIDTH: 3.40 m • LENGTH: 1.65 m
AREA: 5.61 m² • PERIMETER: 10.10 m

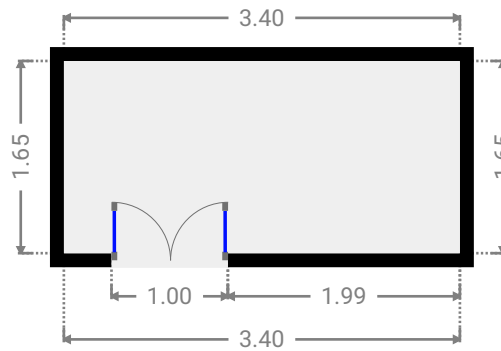
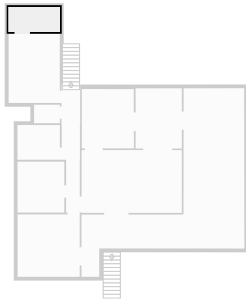

▼ Living Room
1st Floor

WIDTH: 6.62 m • LENGTH: 4.15 m
AREA: 27.46 m² • PERIMETER: 21.54 m

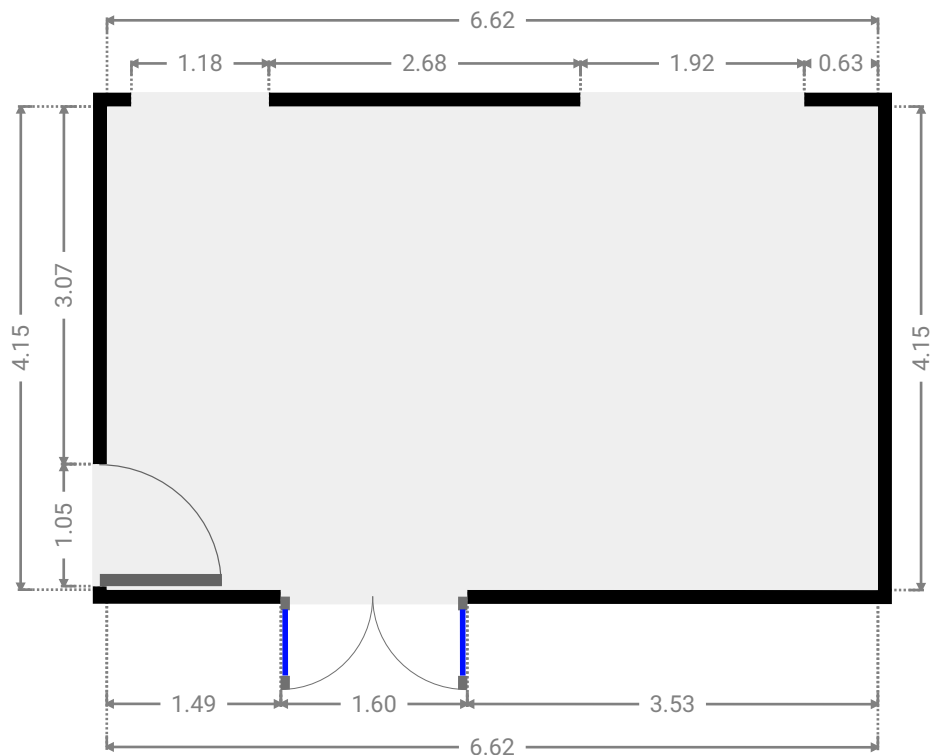
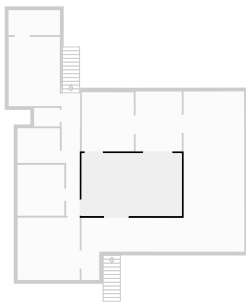

▼ **Dining Room**
1st Floor

WIDTH: 3.05 m • LENGTH: 3.98 m
AREA: 12.14 m² • PERIMETER: 14.06 m

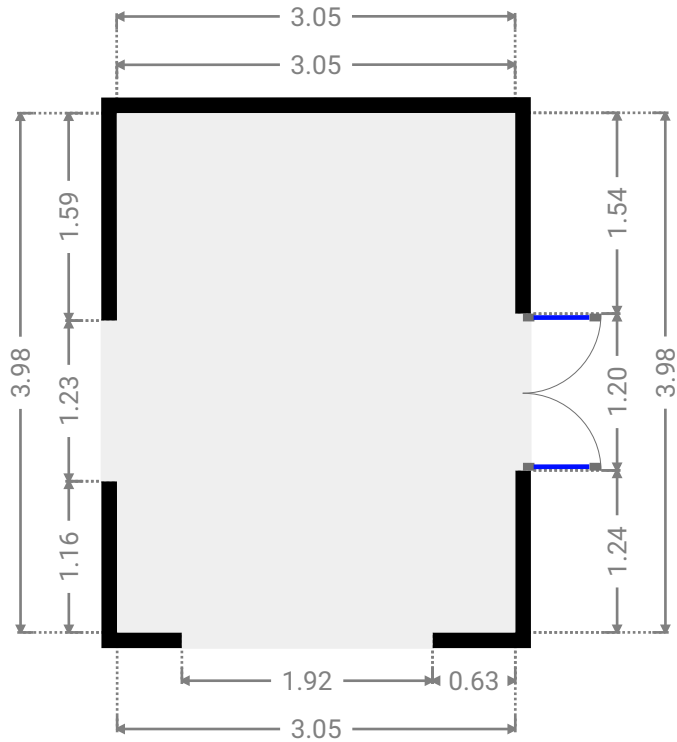
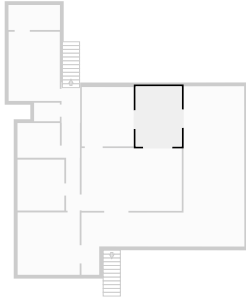

▼ **Kitchen**
1st Floor

WIDTH: 3.44 m • LENGTH: 3.92 m
AREA: 13.45 m² • PERIMETER: 14.70 m

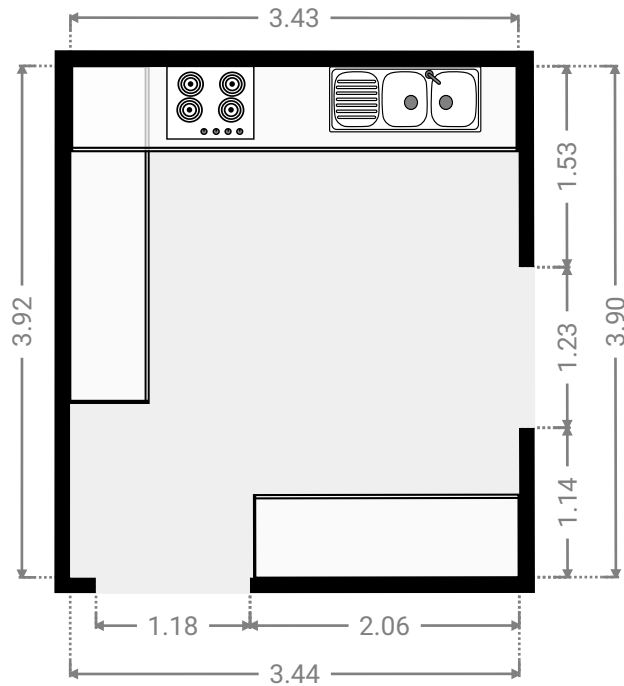
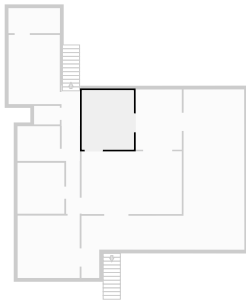

▼ Other
1st Floor

WIDTH: 10.77 m • LENGTH: 12.47 m
AREA: 59.75 m² • PERIMETER: 46.43 m

