

179 High Street

SUBMITTED BY

Ray White Rockhampton Casey
stockers@cqoz.com

CREATED ON

2022-06-28

Floors

2

▼ Ground Floor

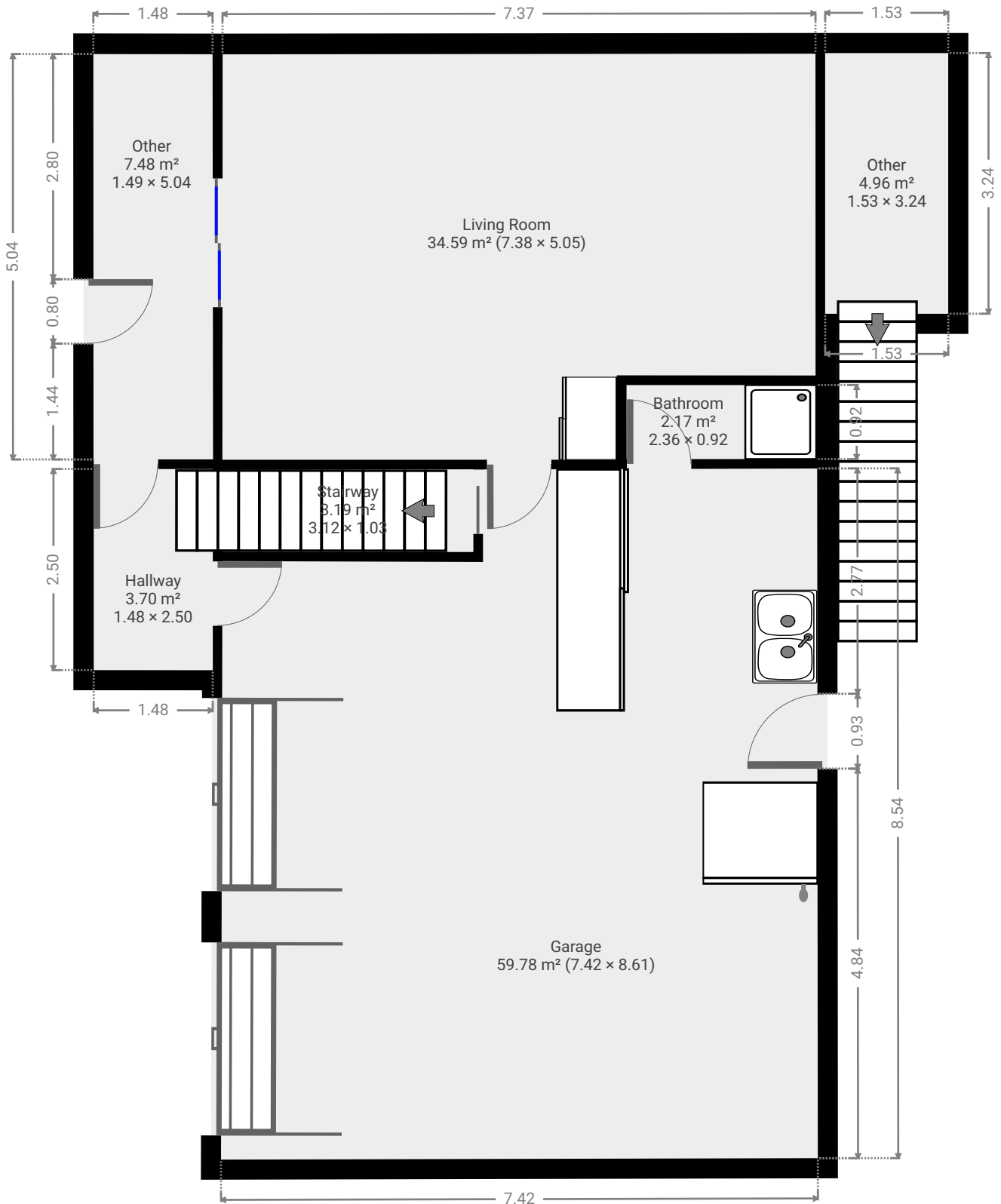

▼ **Bathroom**
Ground Floor

WIDTH: 0.92 m • LENGTH: 2.36 m
AREA: 2.17 m² • PERIMETER: 6.56 m

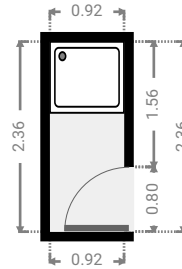
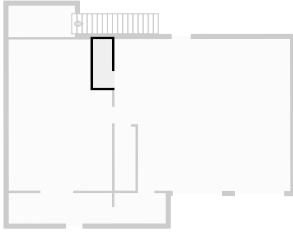

▼ **Garage**
Ground Floor

WIDTH: 8.61 m • LENGTH: 7.42 m
AREA: 59.78 m² • PERIMETER: 31.98 m

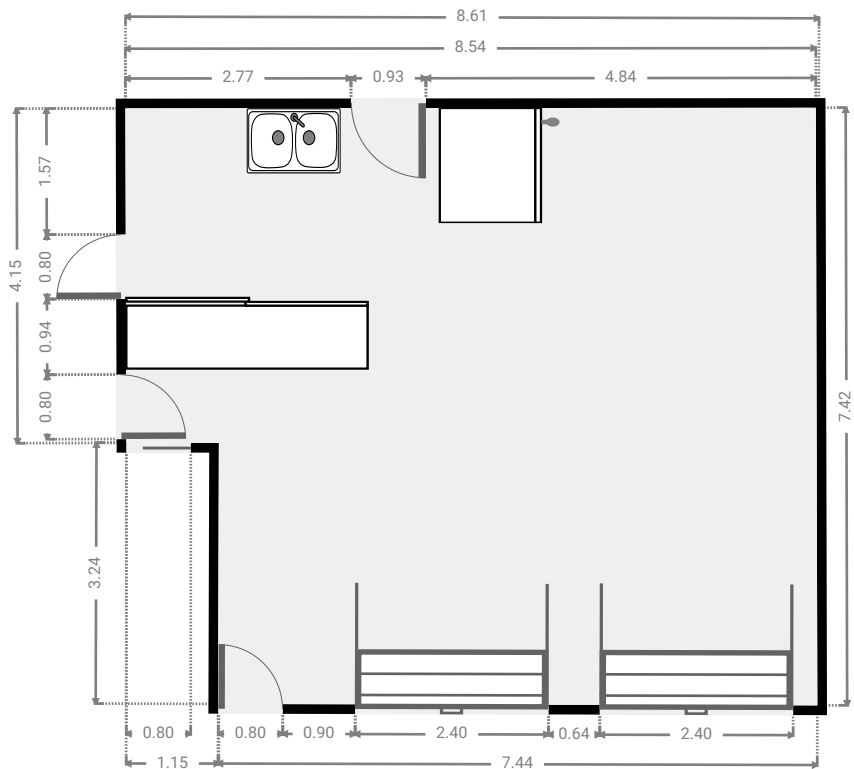
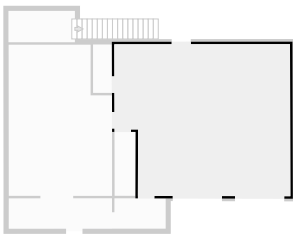

▼ **Hallway**
Ground Floor

WIDTH: 2.50 m • LENGTH: 1.48 m
AREA: 3.70 m² • PERIMETER: 7.96 m

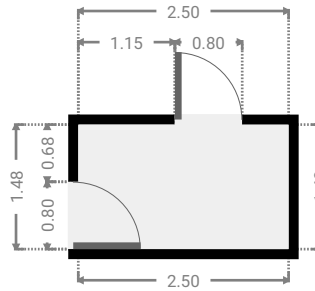
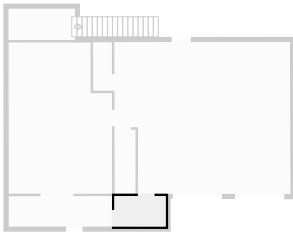

▼ **Living Room**
Ground Floor

WIDTH: 5.05 m • LENGTH: 7.38 m
AREA: 34.59 m² • PERIMETER: 24.83 m

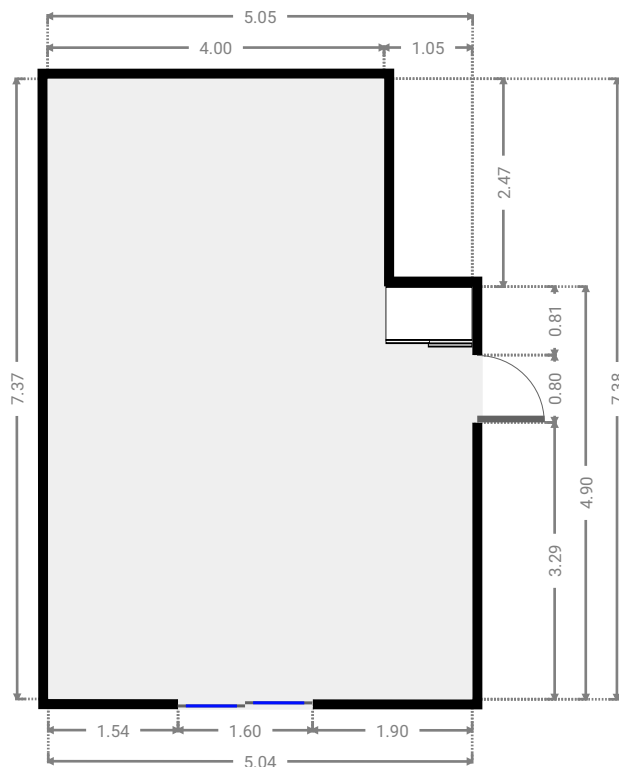
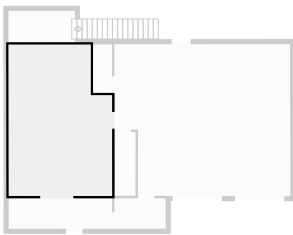

▼ Other
Ground Floor

WIDTH: 3.24 m • LENGTH: 1.53 m
AREA: 4.96 m² • PERIMETER: 9.54 m

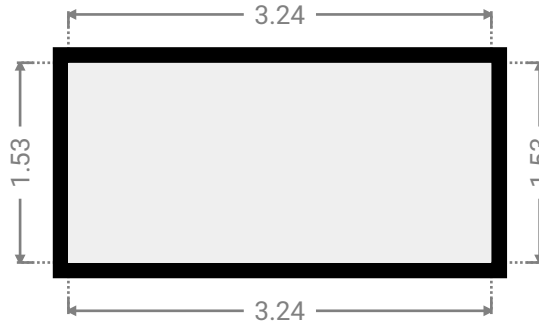
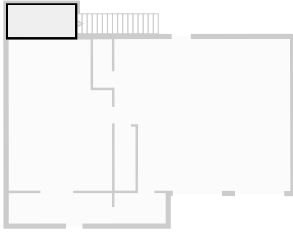

▼ Other
Ground Floor

WIDTH: 5.04 m • LENGTH: 1.49 m
AREA: 7.48 m² • PERIMETER: 13.04 m

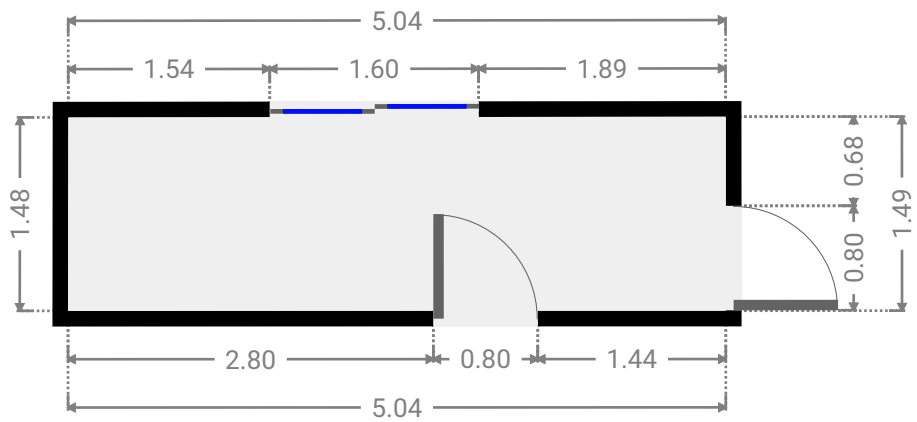

▼ **Stairway**
Ground Floor

WIDTH: 1.03 m • LENGTH: 3.12 m
AREA: 3.19 m² • PERIMETER: 8.28 m

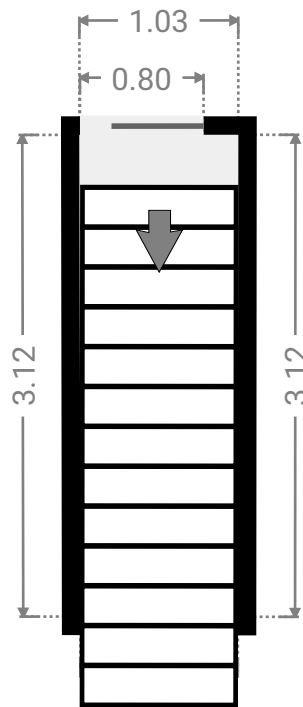
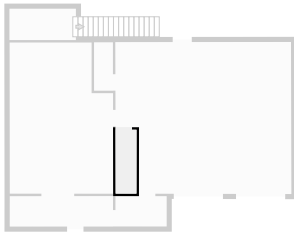

▼ 1st Floor

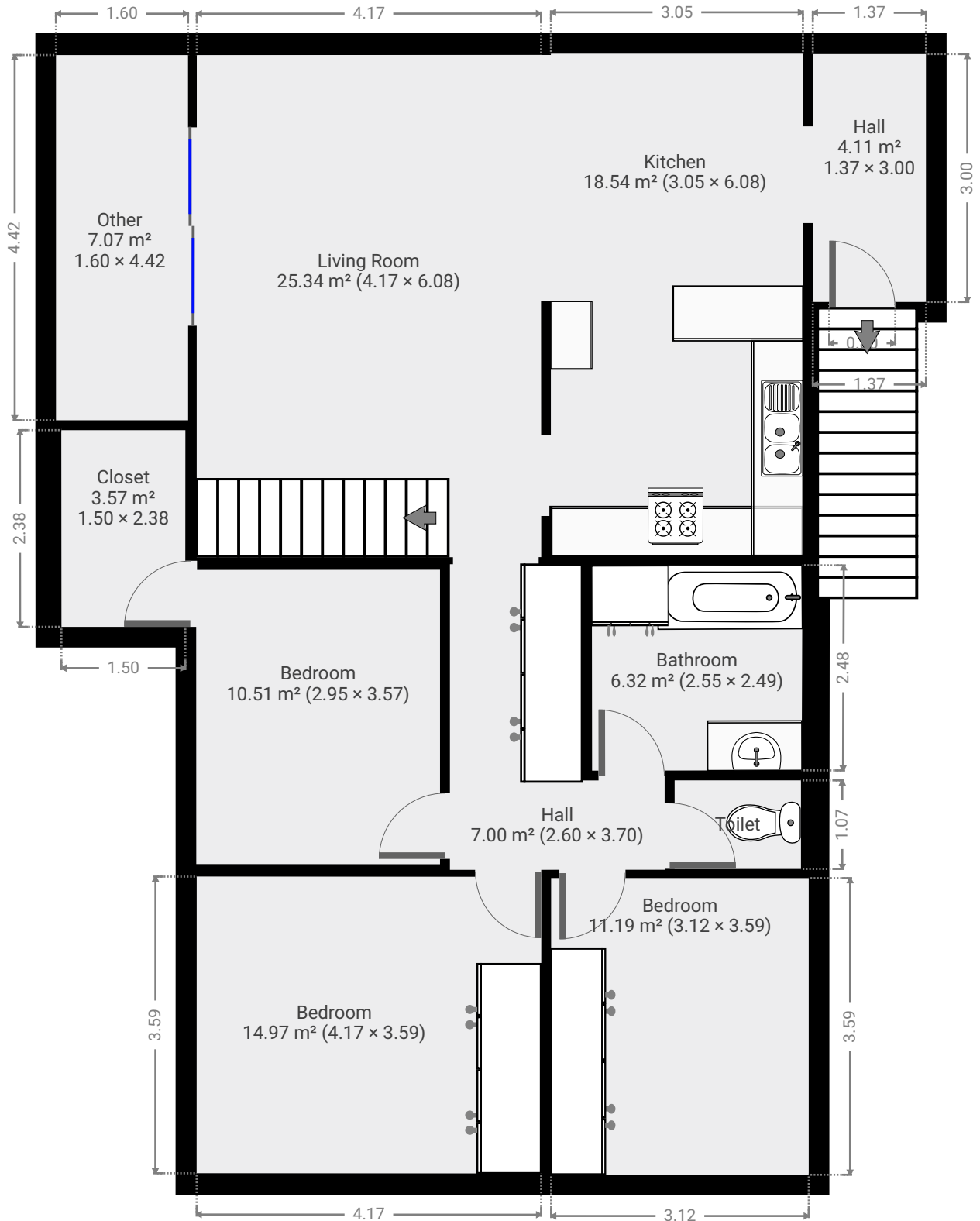

▼ **Bathroom**
1st Floor

WIDTH: 2.49 m • LENGTH: 2.55 m
AREA: 6.32 m² • PERIMETER: 10.05 m

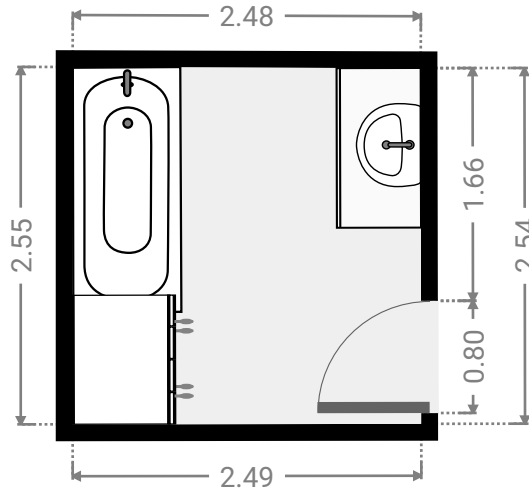
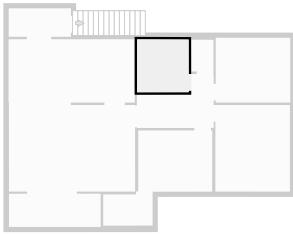

▼ **Bedroom**
1st Floor

WIDTH: 3.57 m • LENGTH: 2.95 m
AREA: 10.51 m² • PERIMETER: 13.03 m

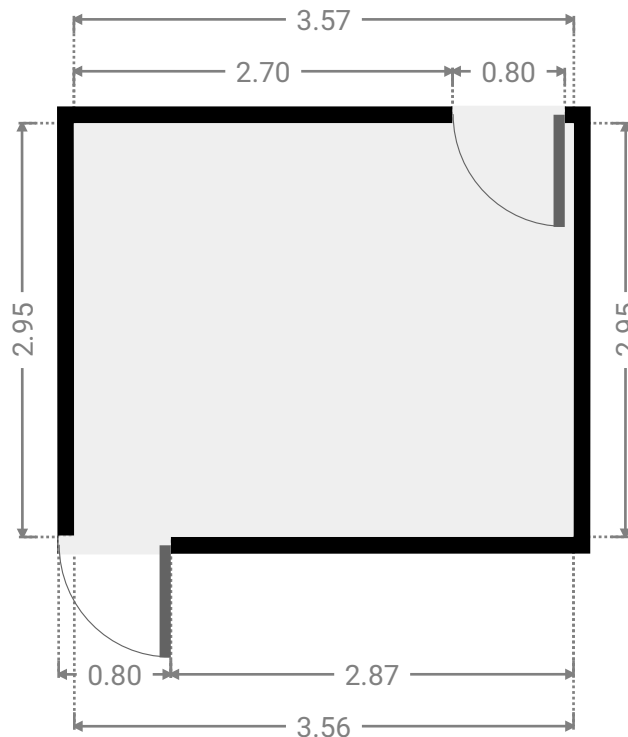
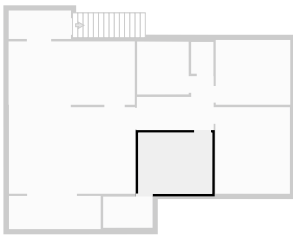

▼ **Closet**
1st Floor

WIDTH: 2.38 m • LENGTH: 1.50 m
AREA: 3.57 m² • PERIMETER: 7.76 m

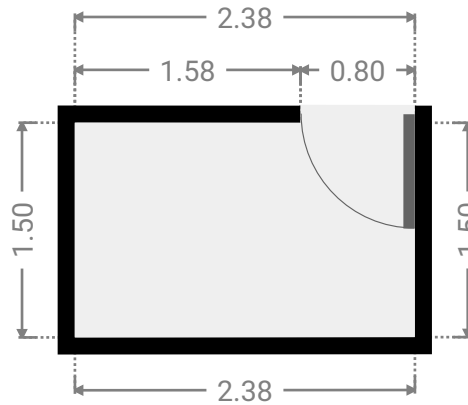
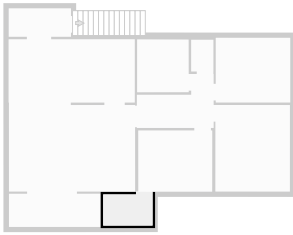

▼ **Bedroom**
1st Floor

WIDTH: 3.59 m • LENGTH: 4.17 m
AREA: 14.97 m² • PERIMETER: 15.52 m

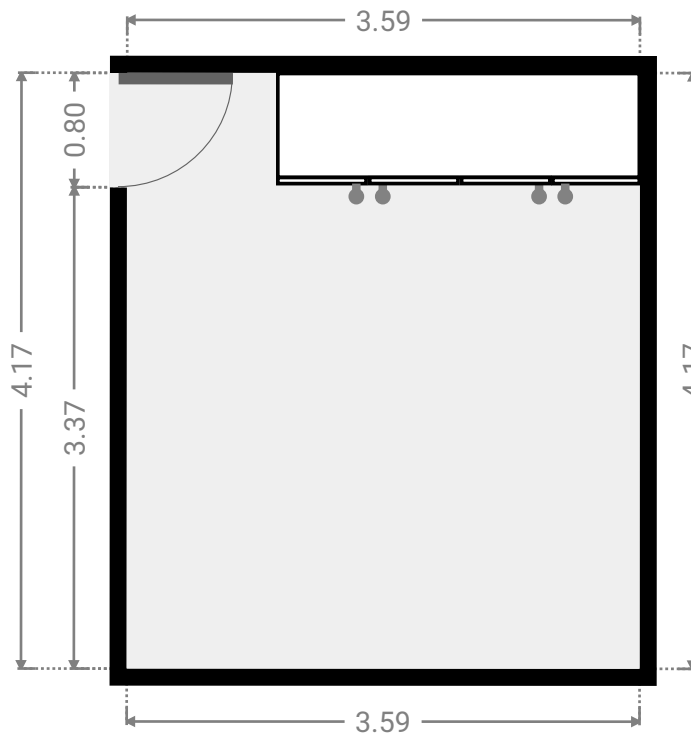
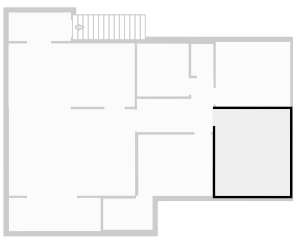

▼ **Bedroom**
1st Floor

WIDTH: 3.59 m • LENGTH: 3.12 m
AREA: 11.19 m² • PERIMETER: 13.42 m

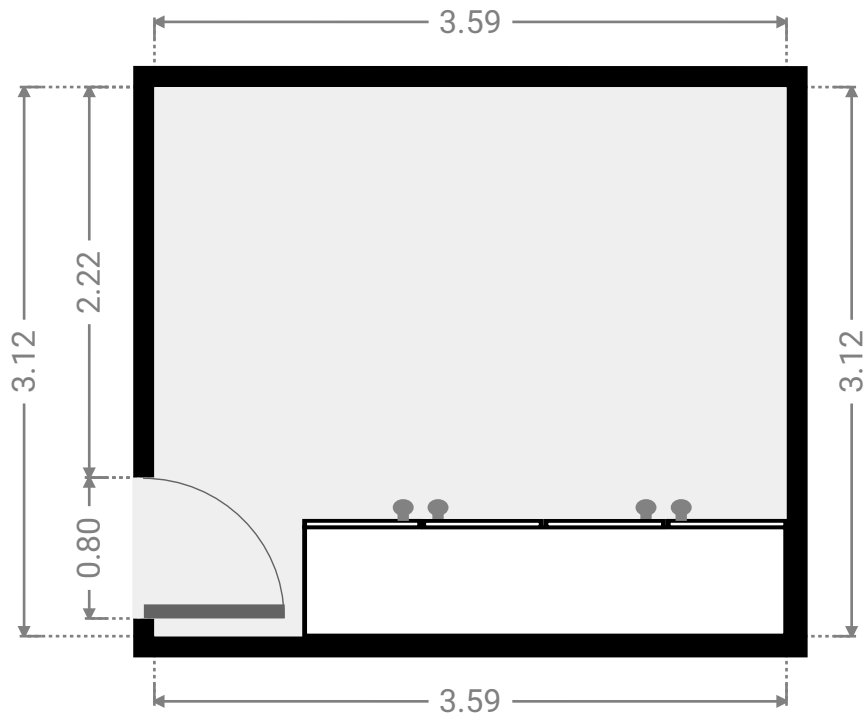
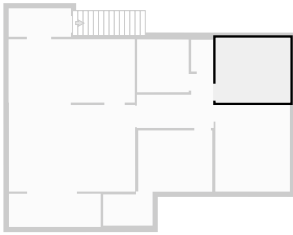

▼ **Hall**
1st Floor

WIDTH: 3.00 m • LENGTH: 1.37 m
AREA: 4.11 m² • PERIMETER: 8.74 m

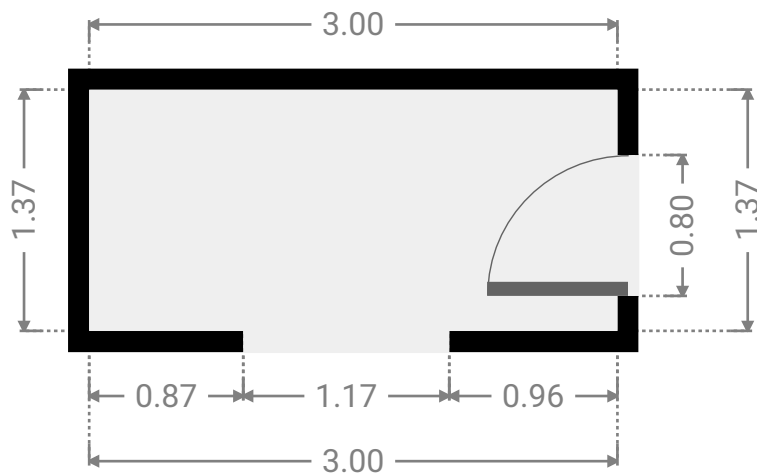
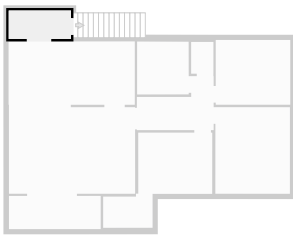

▼ **Hall**
1st Floor

WIDTH: 3.70 m • LENGTH: 2.60 m
AREA: 7.00 m² • PERIMETER: 12.60 m

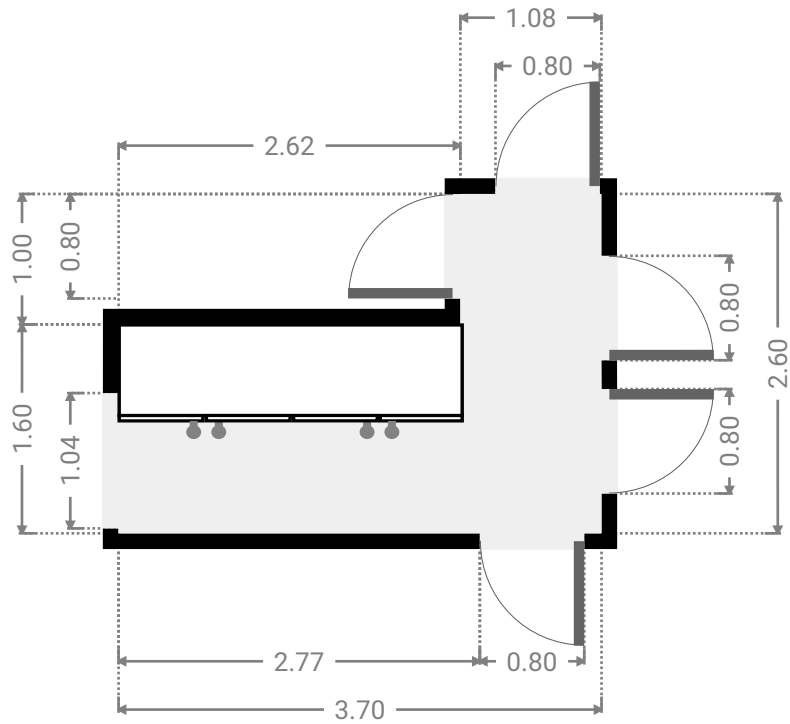
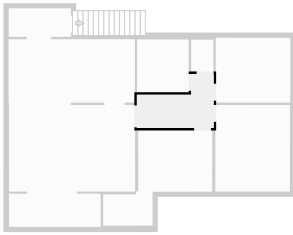

▼ **Kitchen**
1st Floor

WIDTH: 6.08 m • LENGTH: 3.05 m
AREA: 18.54 m² • PERIMETER: 18.26 m

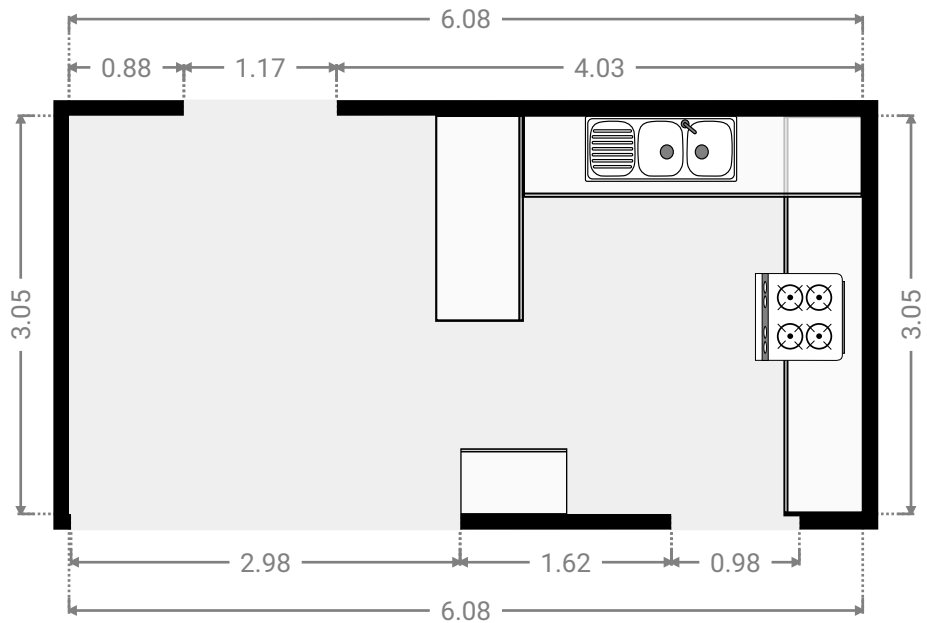
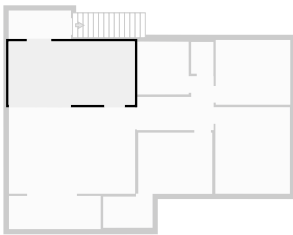

▼ **Living Room**
1st Floor

WIDTH: 6.08 m • LENGTH: 4.17 m
AREA: 25.34 m² • PERIMETER: 20.50 m

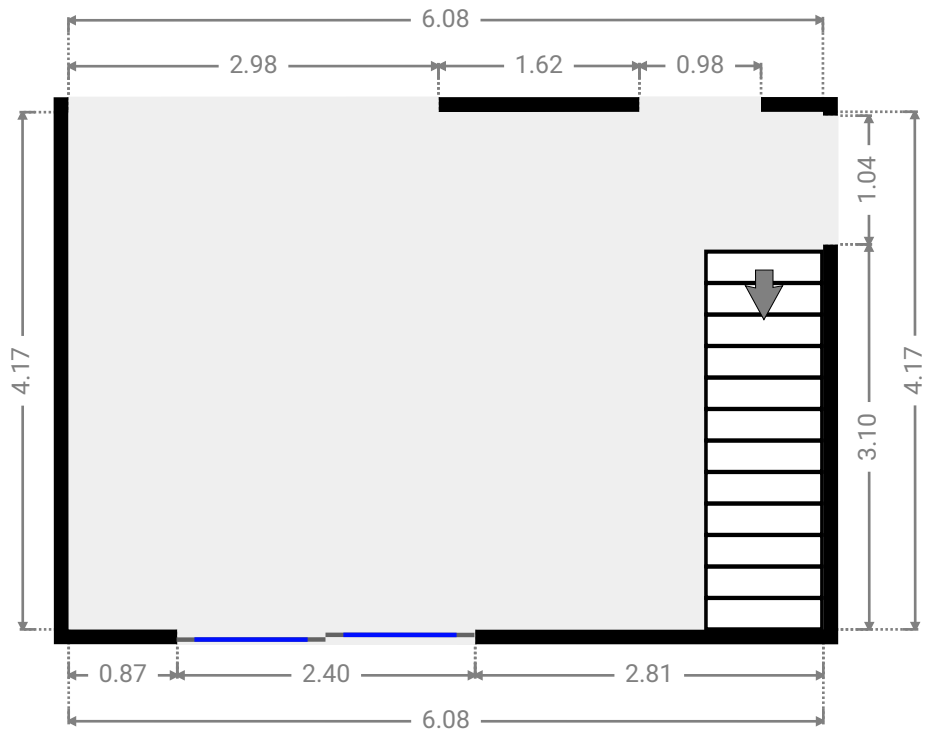
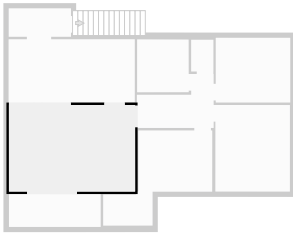

▼ **Other**
1st Floor

WIDTH: 4.42 m • LENGTH: 1.60 m
AREA: 7.07 m² • PERIMETER: 12.04 m

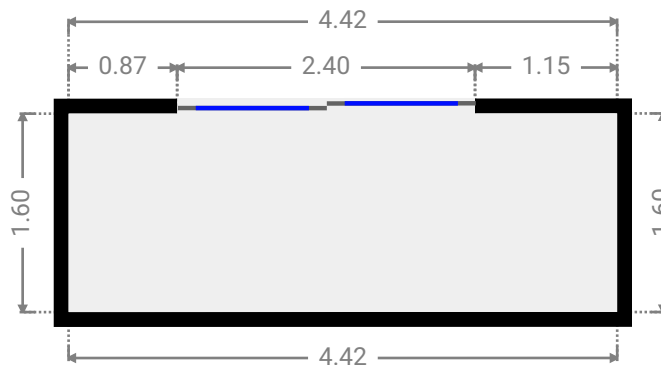
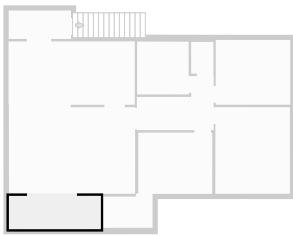

▼ Toilet
1st Floor

WIDTH: 1.07 m • LENGTH: 1.53 m
AREA: 1.64 m² • PERIMETER: 5.20 m

