

172 Denison Lane

Ground Floor

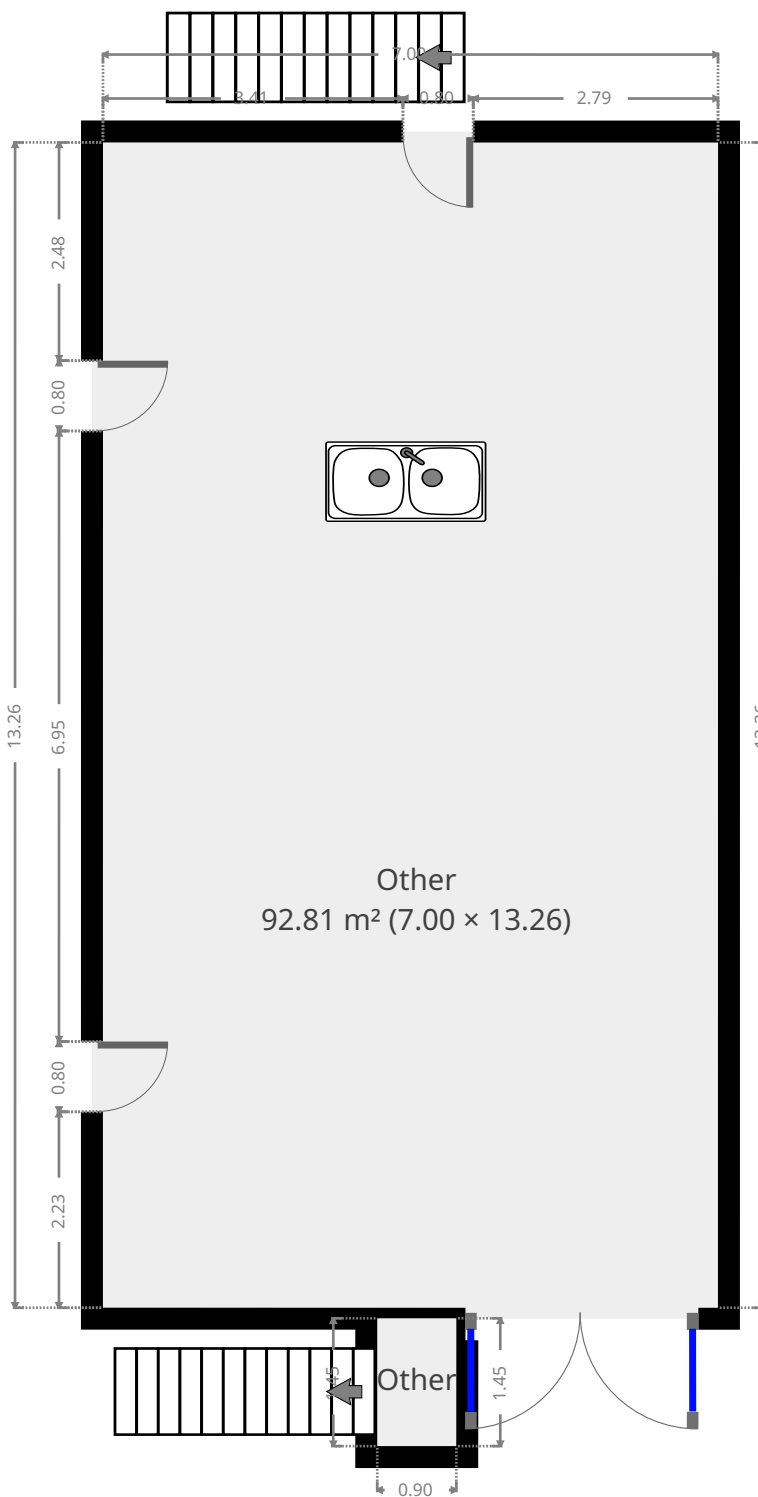

THIS FLOORPLAN IS PROVIDED WITHOUT WARRANTY OF ANY KIND. SENSOPIA DISCLAIMS ANY WARRANTY INCLUDING, WITHOUT LIMITATION, SATISFACTORY QUALITY OR ACCURACY OF DIMENSIONS.

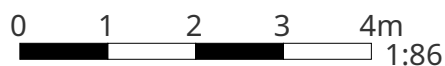

172 Denison Lane

Other

Width: 7.00 m
Length: 13.26 m
Area: 92.81 m²
Perimeter: 40.52 m

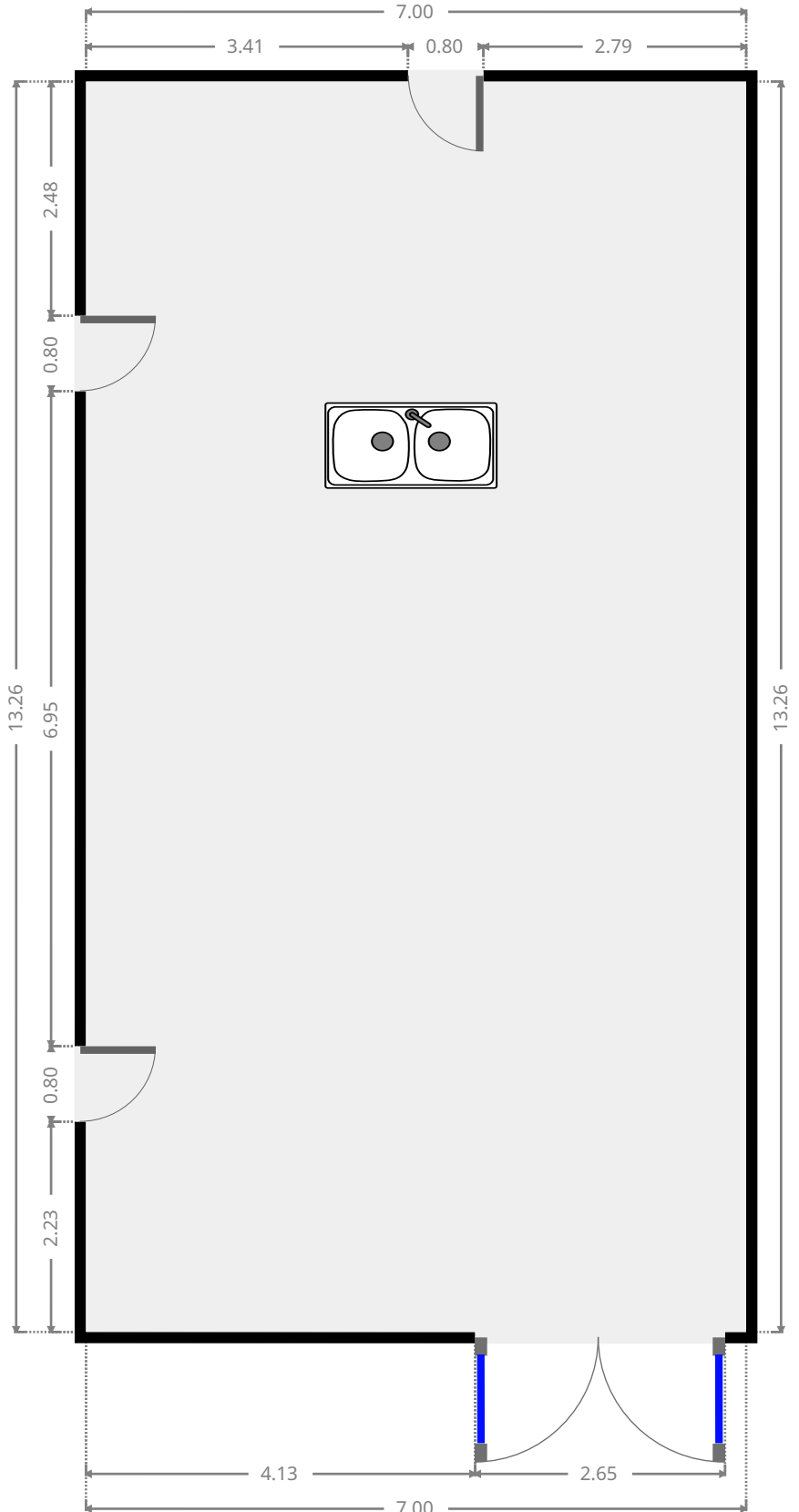
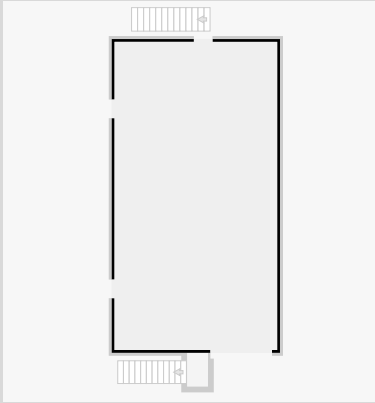

THIS FLOORPLAN IS PROVIDED WITHOUT WARRANTY OF ANY KIND. SENSOPIA DISCLAIMS ANY WARRANTY INCLUDING, WITHOUT LIMITATION, SATISFACTORY QUALITY OR ACCURACY OF DIMENSIONS.



172 Denison Lane

Other

Width: 0.90 m
Length: 1.45 m
Area: 1.31 m²
Perimeter: 4.71 m

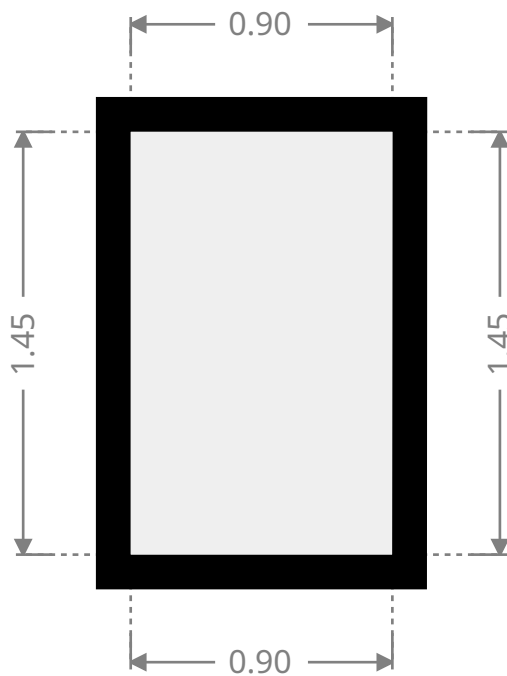
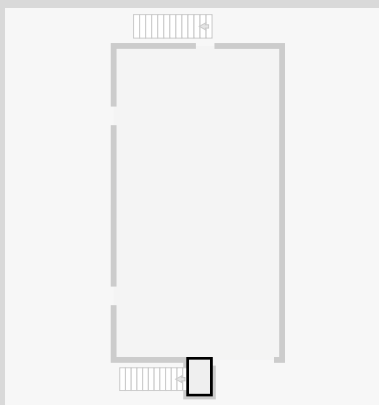

172 Denison Lane

1st Floor

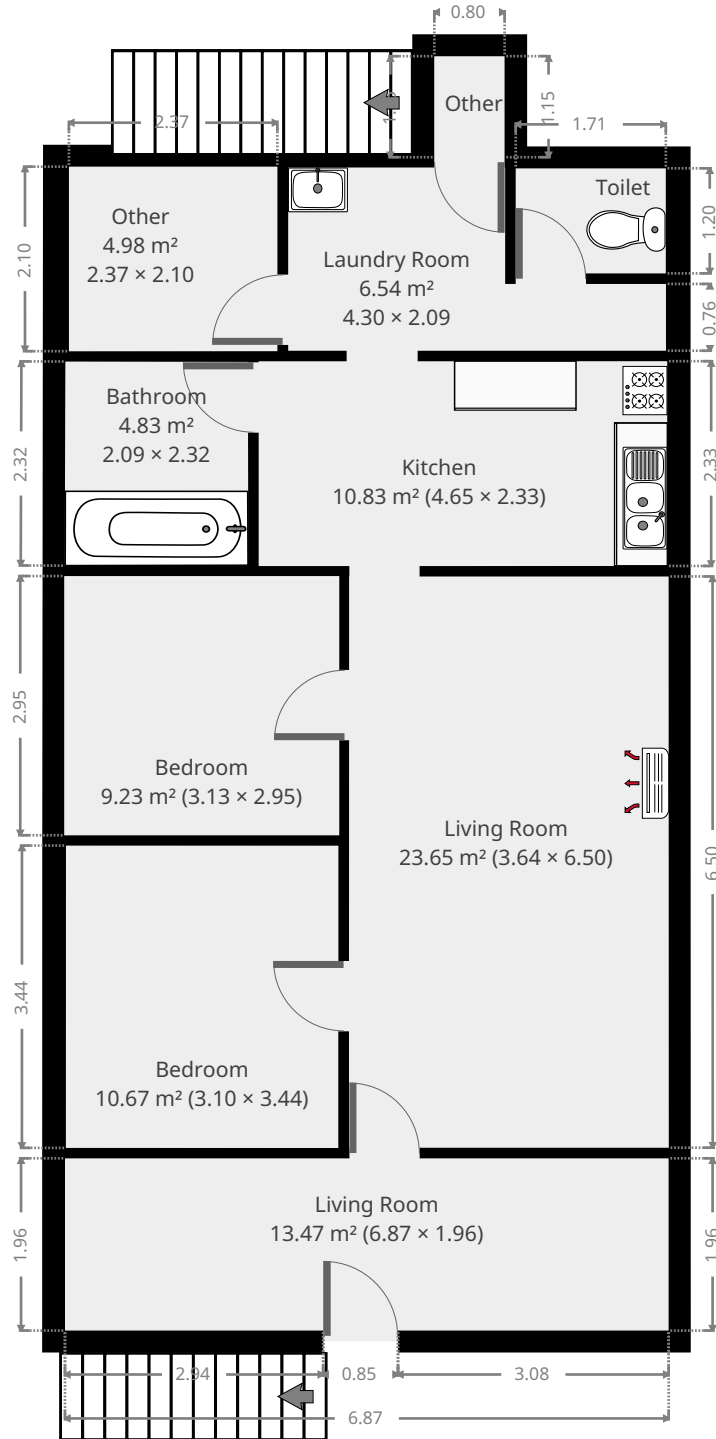

THIS FLOORPLAN IS PROVIDED WITHOUT WARRANTY OF ANY KIND. SENSOPIA DISCLAIMS ANY WARRANTY INCLUDING, WITHOUT LIMITATION, SATISFACTORY QUALITY OR ACCURACY OF DIMENSIONS.



172 Denison Lane

Living Room

Width: 1.96 m
 Length: 6.87 m
 Area: 13.47 m²
 Perimeter: 17.66 m

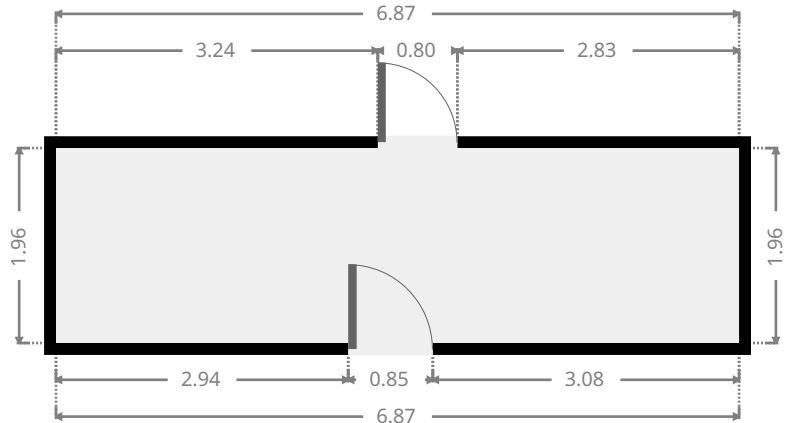
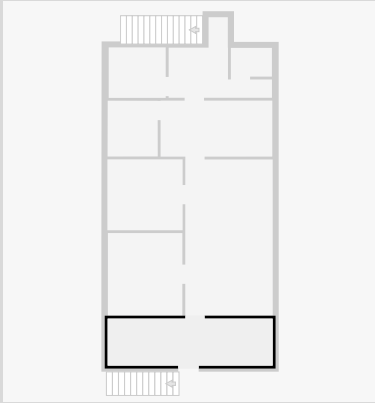

Living Room

Width: 3.64 m
 Length: 6.50 m
 Area: 23.65 m²
 Perimeter: 20.28 m

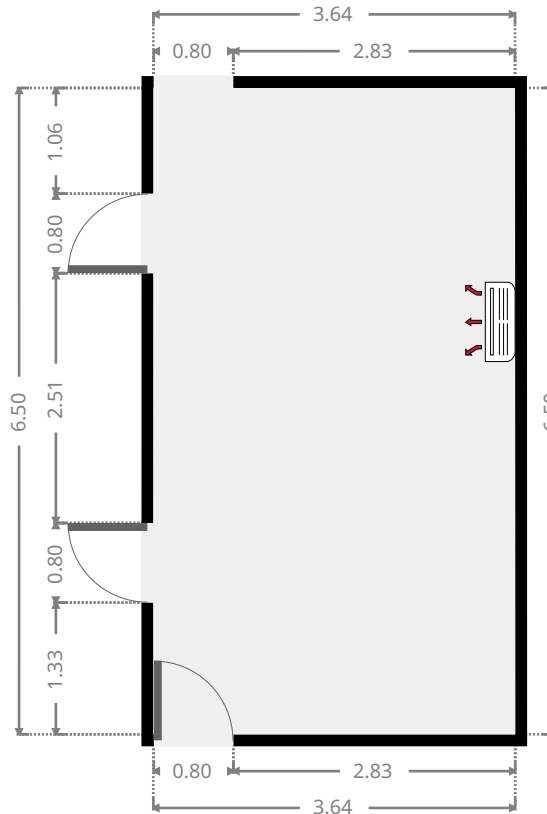
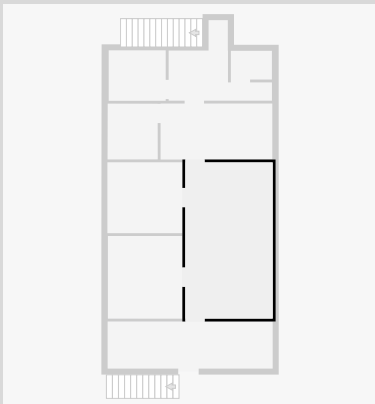

THIS FLOORPLAN IS PROVIDED WITHOUT WARRANTY OF ANY KIND. SENSOPIA DISCLAIMS ANY WARRANTY INCLUDING, WITHOUT LIMITATION, SATISFACTORY QUALITY OR ACCURACY OF DIMENSIONS.



172 Denison Lane

Bedroom

Width: 3.10 m
Length: 3.44 m
Area: 10.67 m²
Perimeter: 13.08 m

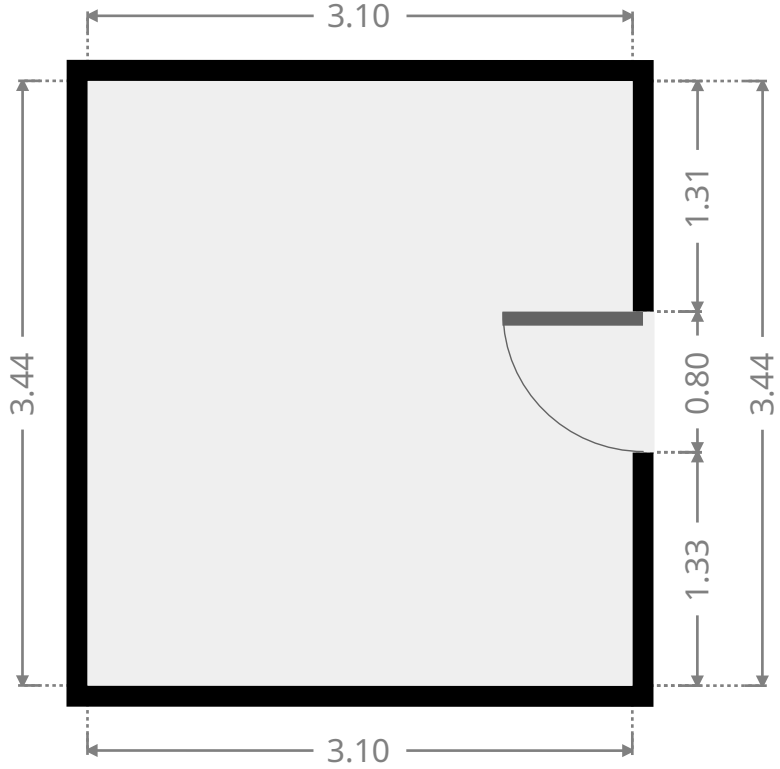
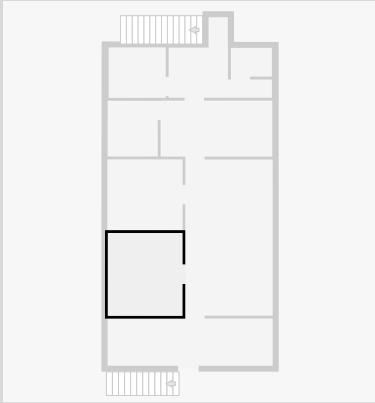

Bedroom

Width: 2.95 m
Length: 3.13 m
Area: 9.23 m²
Perimeter: 12.16 m

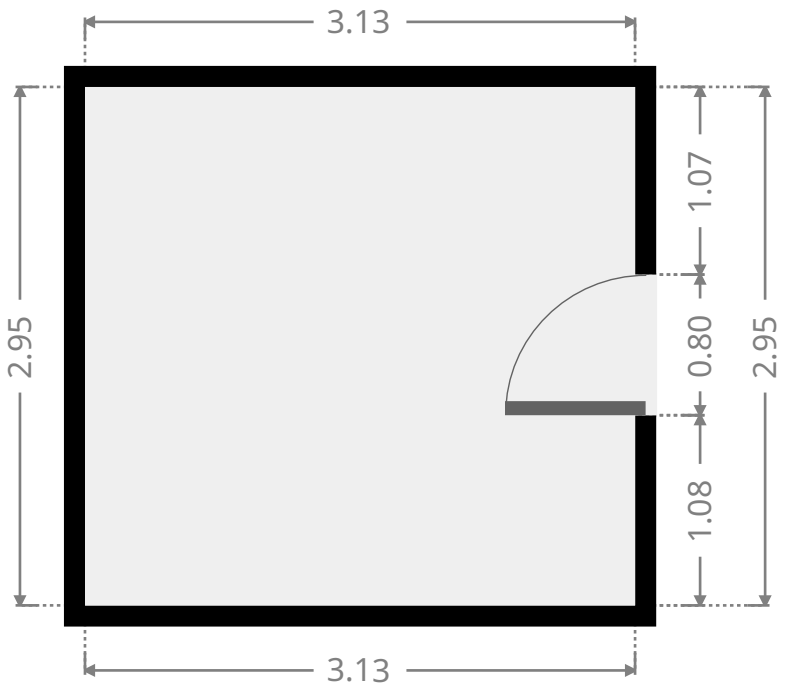
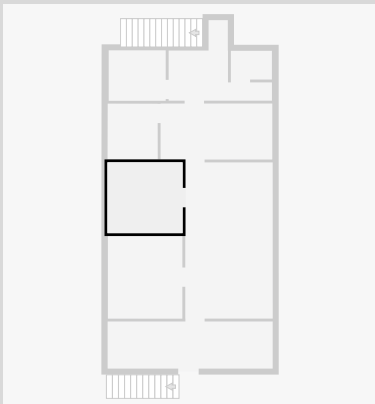

THIS FLOORPLAN IS PROVIDED WITHOUT WARRANTY OF ANY KIND. SENSOPIA DISCLAIMS ANY WARRANTY INCLUDING, WITHOUT LIMITATION, SATISFACTORY QUALITY OR ACCURACY OF DIMENSIONS.

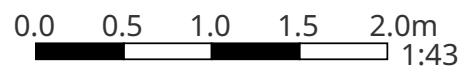

172 Denison Lane

Kitchen

Width: 2.33 m
Length: 4.65 m
Area: 10.83 m²
Perimeter: 13.96 m

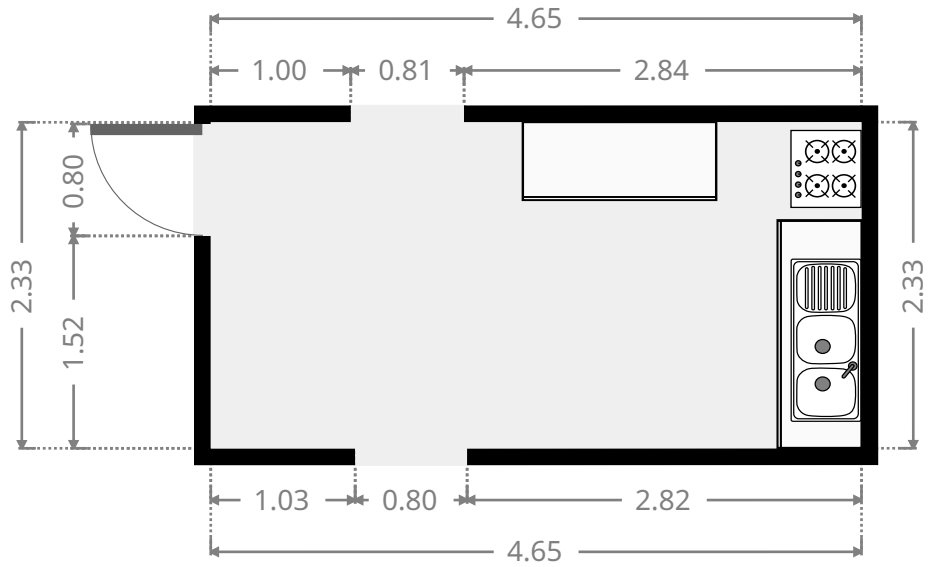
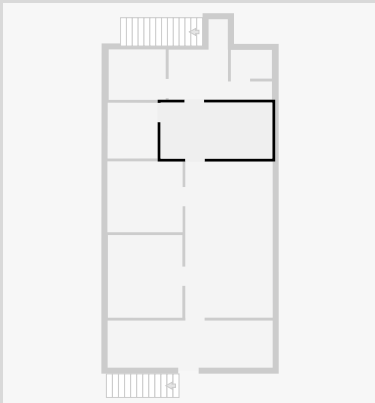

Bathroom

Width: 2.09 m
Length: 2.32 m
Area: 4.83 m²
Perimeter: 8.81 m

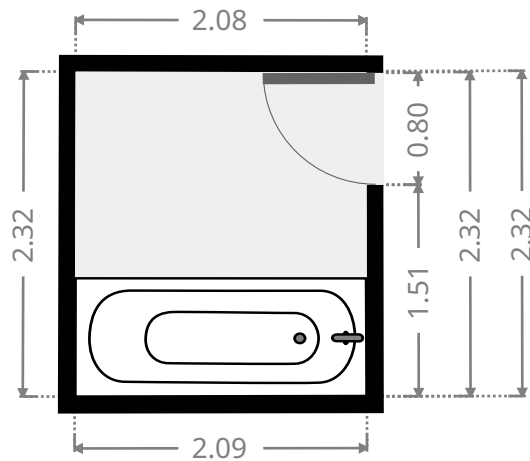
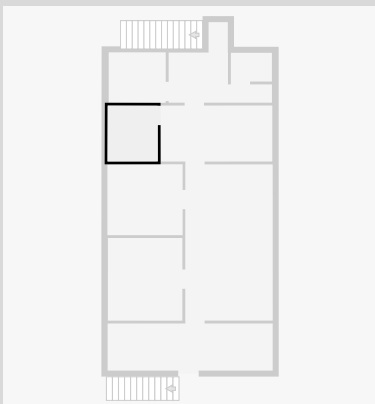

THIS FLOORPLAN IS PROVIDED WITHOUT WARRANTY OF ANY KIND. SENSOPIA DISCLAIMS ANY WARRANTY INCLUDING, WITHOUT LIMITATION, SATISFACTORY QUALITY OR ACCURACY OF DIMENSIONS.

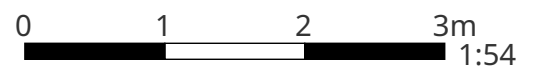

172 Denison Lane

Laundry Room

Width: 2.09 m
 Length: 4.30 m
 Area: 6.54 m²
 Perimeter: 12.77 m

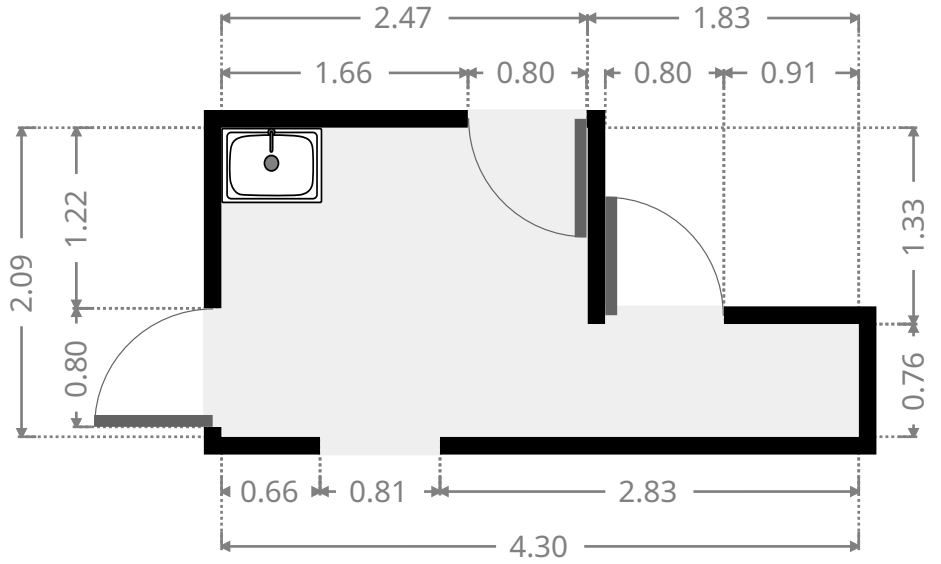
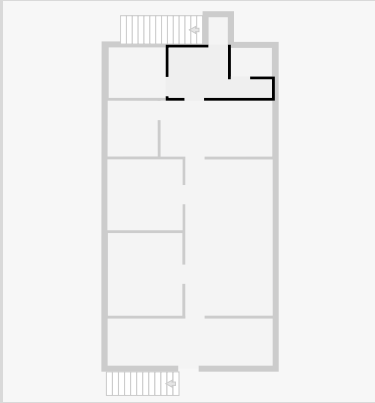

Toilet / Half Bath

Width: 1.20 m
 Length: 1.71 m
 Area: 2.04 m²
 Perimeter: 5.81 m

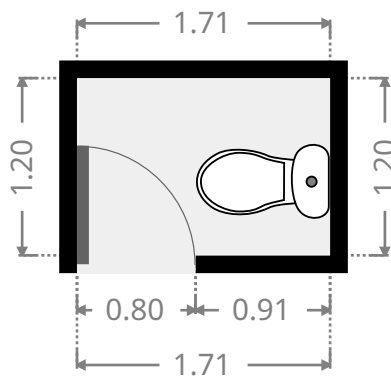
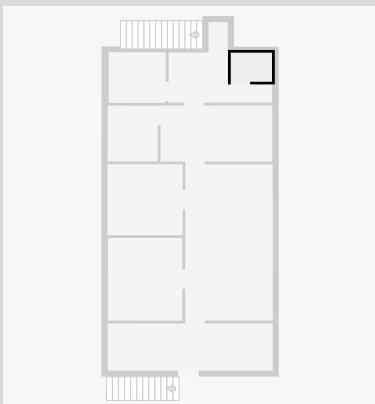

THIS FLOORPLAN IS PROVIDED WITHOUT WARRANTY OF ANY KIND. SENSOPIA DISCLAIMS ANY WARRANTY INCLUDING, WITHOUT LIMITATION, SATISFACTORY QUALITY OR ACCURACY OF DIMENSIONS.

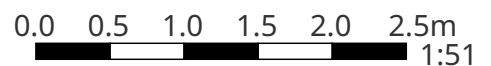

172 Denison Lane

Other

Width: 2.10 m
 Length: 2.37 m
 Area: 4.98 m²
 Perimeter: 8.94 m

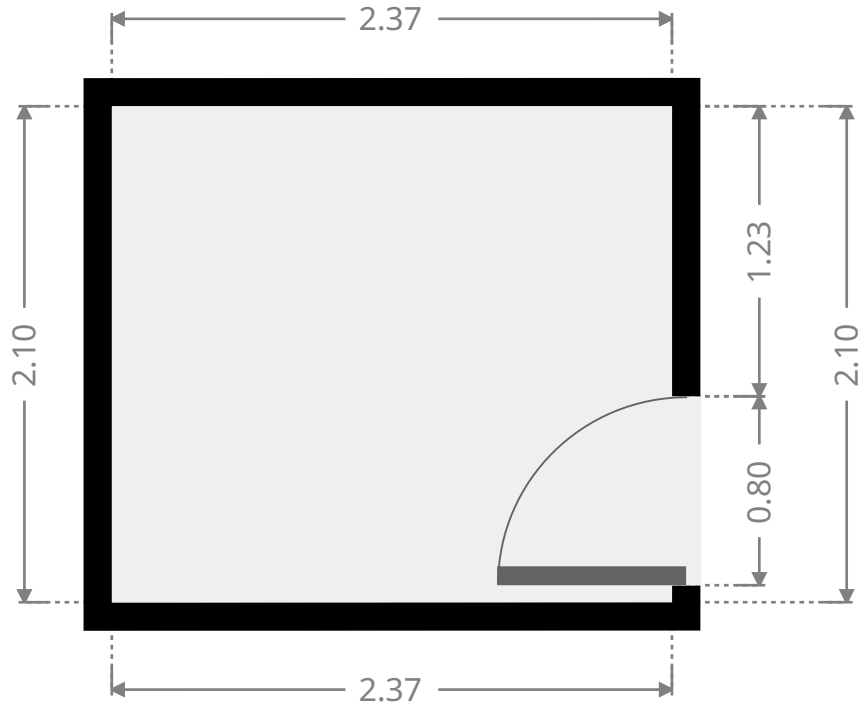
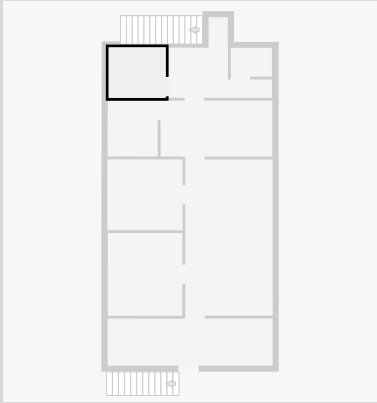

Other

Width: 0.80 m
 Length: 1.15 m
 Area: 0.92 m²
 Perimeter: 3.90 m

