

171 Stamford Street

SUBMITTED BY

Ray White Rockhampton Casey
stockers@cqoz.com

CREATED ON

2022-06-22

Floors

2

▼ Ground Floor

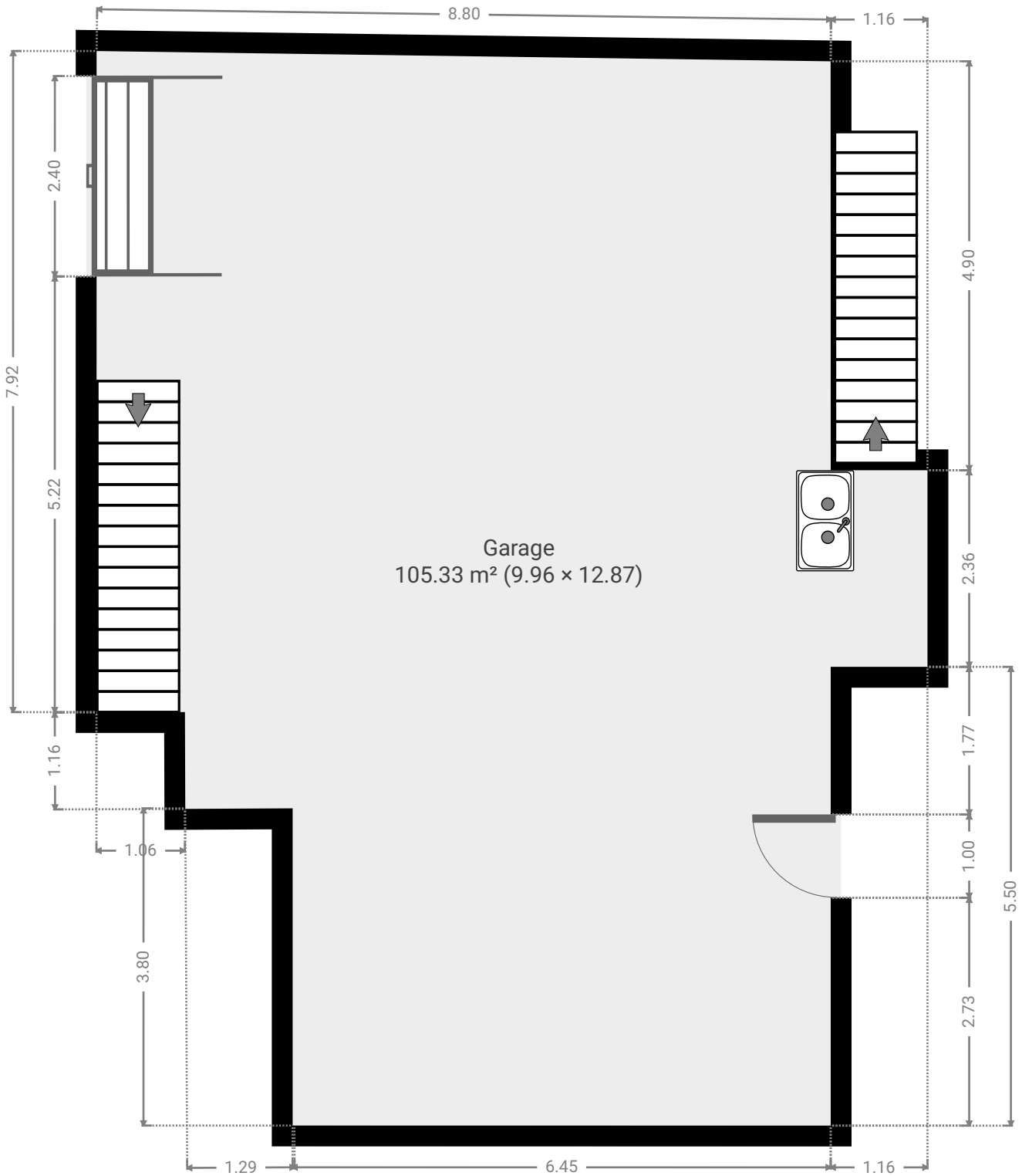

▼ **Garage**
Ground Floor

WIDTH: 12.87 m • LENGTH: 9.96 m
AREA: 105.33 m² • PERIMETER: 45.55 m

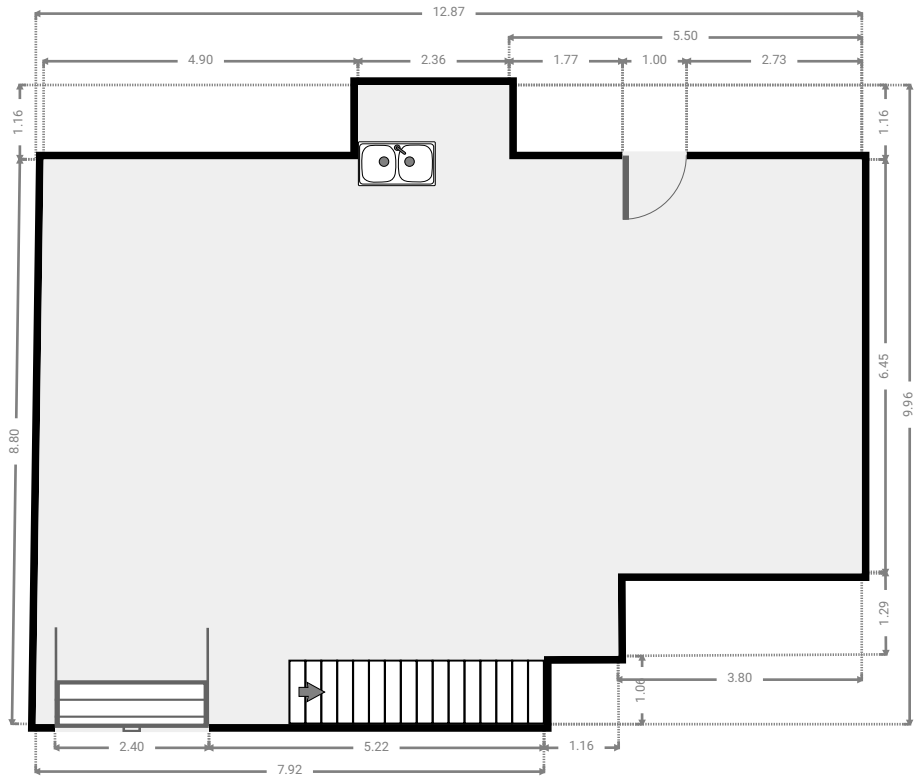
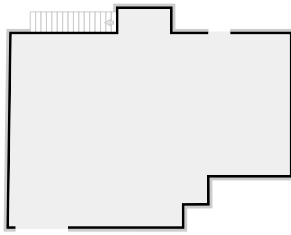

▼ 1st Floor

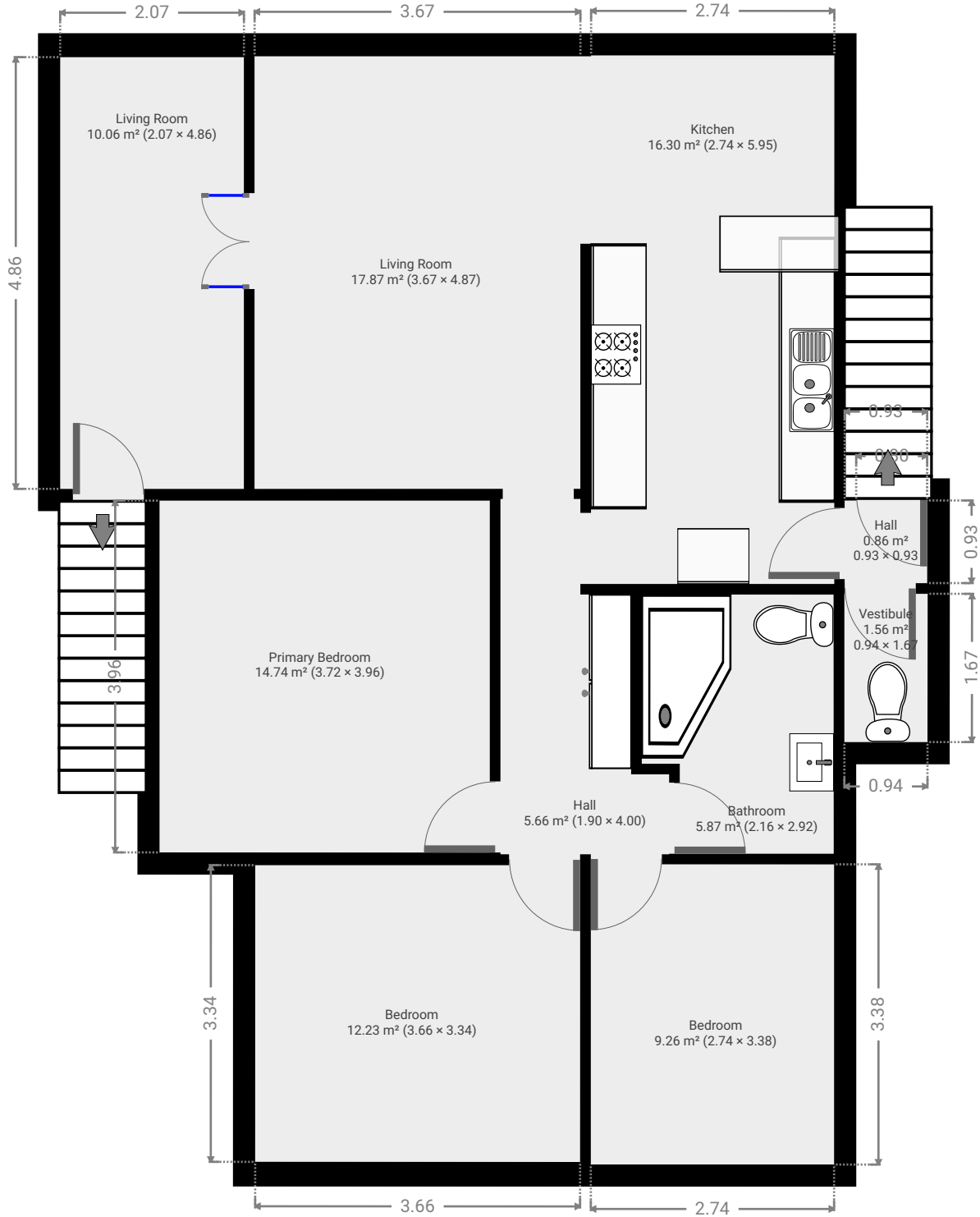

▼ **Bathroom**
1st Floor

WIDTH: 2.92 m • LENGTH: 2.16 m
AREA: 5.87 m² • PERIMETER: 10.16 m

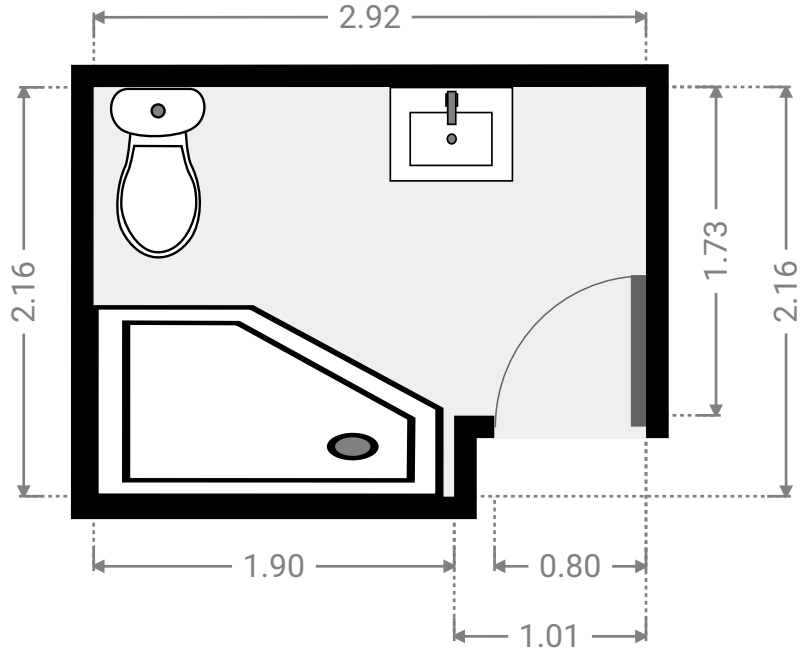
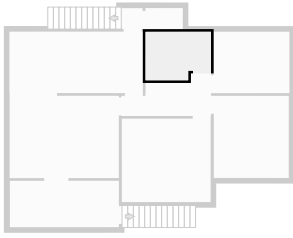

▼ **Bedroom**
1st Floor

WIDTH: 3.38 m • LENGTH: 2.74 m
AREA: 9.26 m² • PERIMETER: 12.24 m

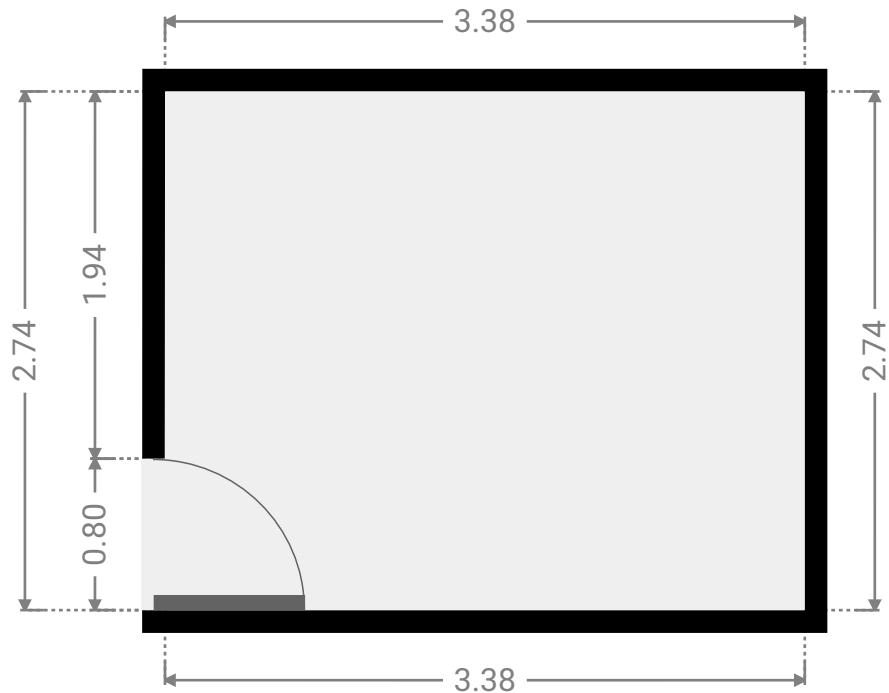
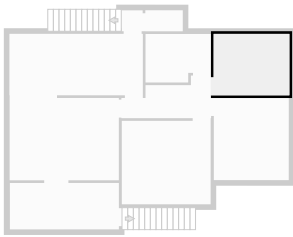

▼ **Bedroom**
1st Floor

WIDTH: 3.34 m • LENGTH: 3.66 m
AREA: 12.23 m² • PERIMETER: 14.00 m

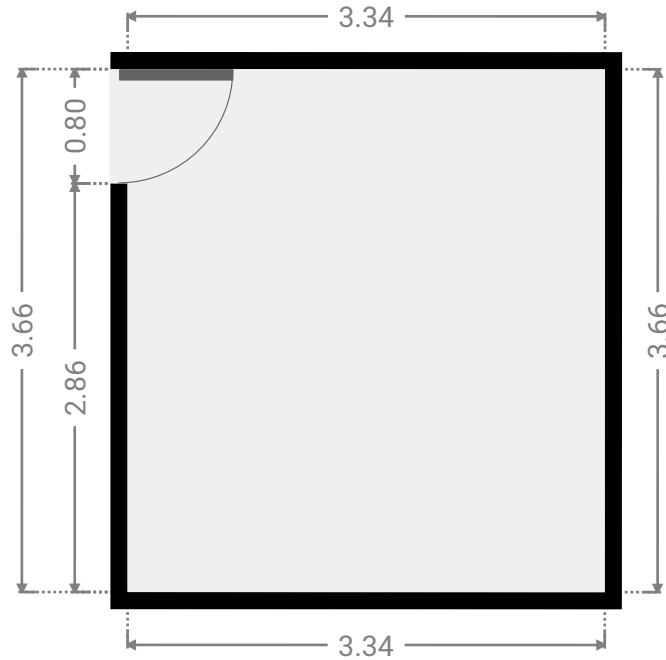
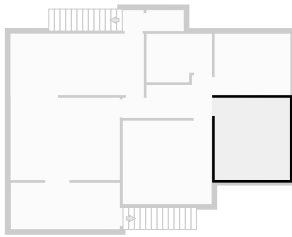

▼ **Hall**
1st Floor

WIDTH: 4.00 m • LENGTH: 1.90 m
AREA: 5.66 m² • PERIMETER: 11.80 m

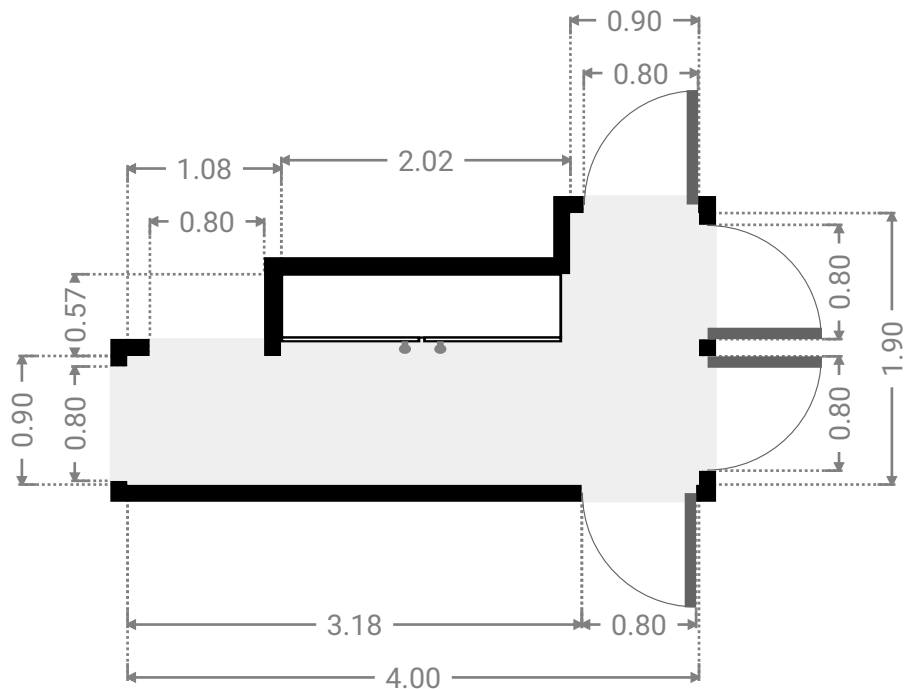
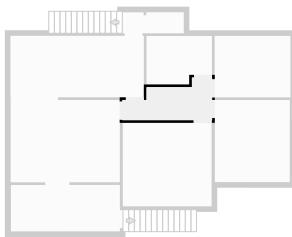

▼ **Hall**
1st Floor

WIDTH: 0.93 m • LENGTH: 0.93 m
AREA: 0.86 m² • PERIMETER: 3.72 m

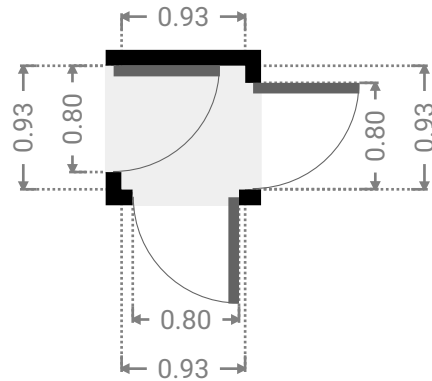
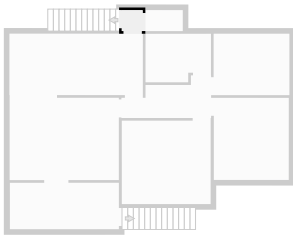

▼ **Kitchen**
1st Floor

WIDTH: 5.95 m • LENGTH: 2.74 m
AREA: 16.30 m² • PERIMETER: 17.38 m

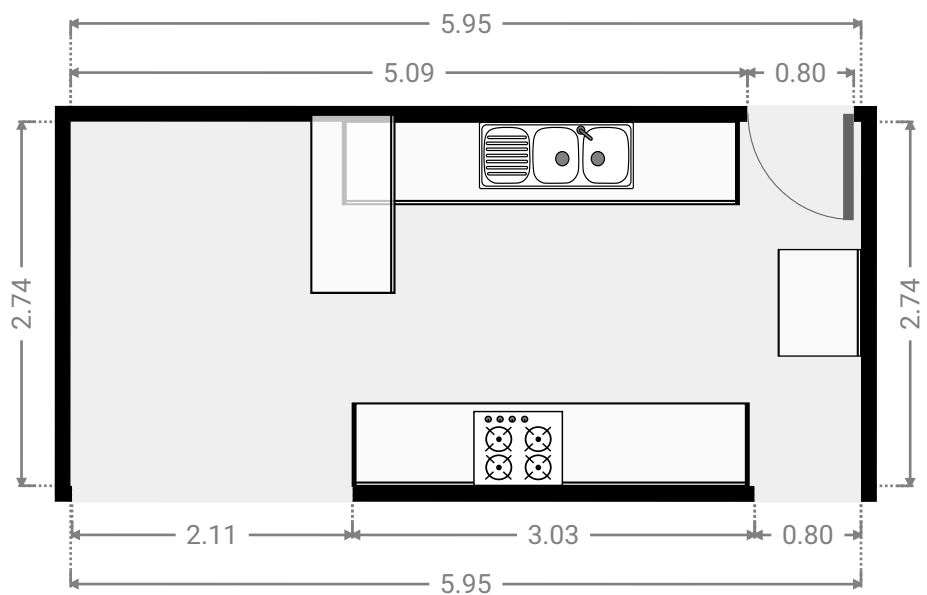
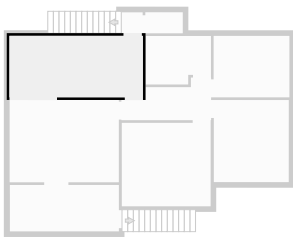

▼ Living Room
1st Floor

WIDTH: 4.86 m • LENGTH: 2.07 m
AREA: 10.06 m² • PERIMETER: 13.86 m

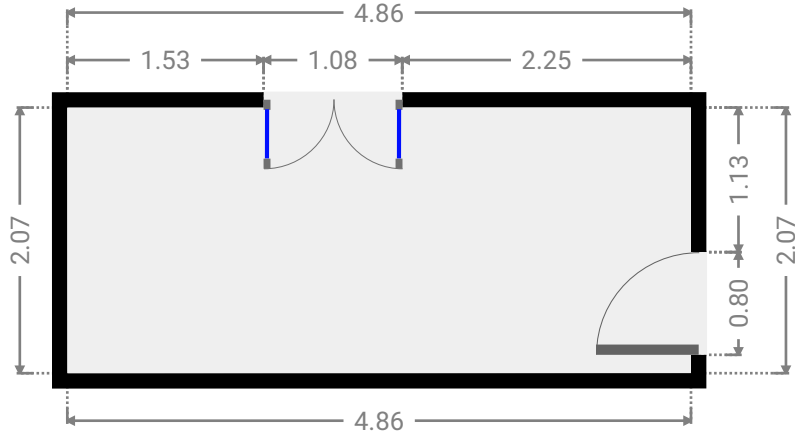
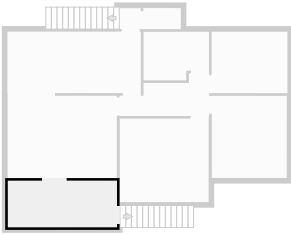

▼ Living Room
1st Floor

WIDTH: 4.87 m • LENGTH: 3.67 m
AREA: 17.87 m² • PERIMETER: 17.08 m

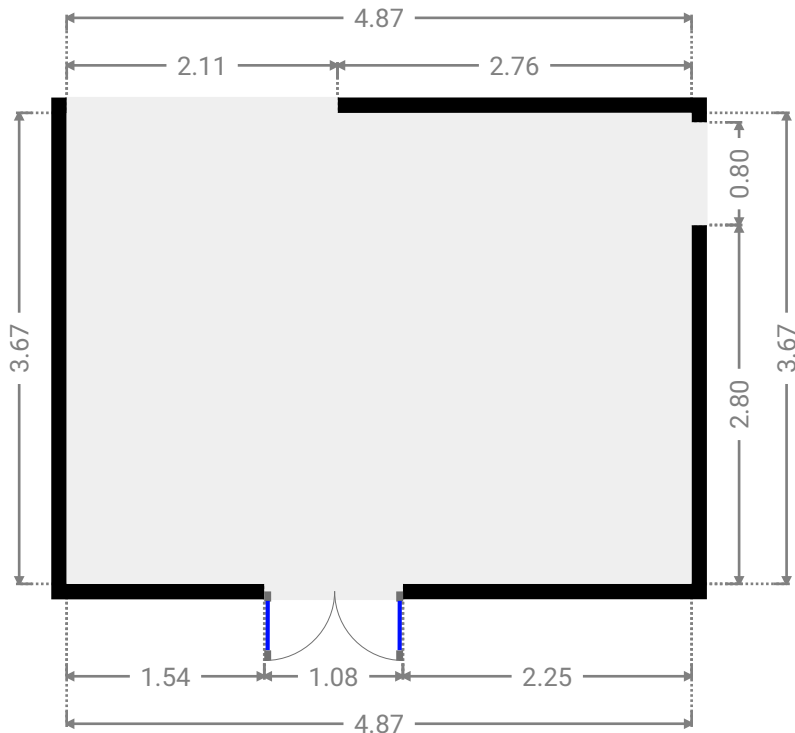
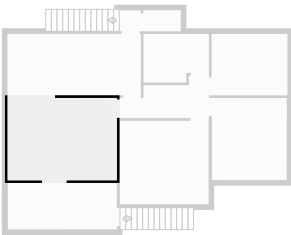

▼ **Primary Bedroom**
1st Floor

WIDTH: 3.96 m • LENGTH: 3.72 m
AREA: 14.74 m² • PERIMETER: 15.36 m

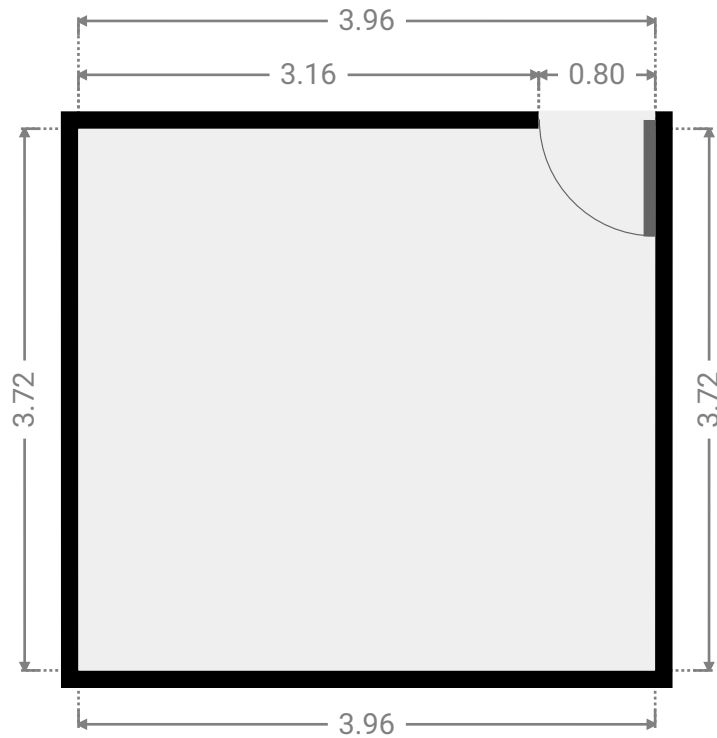
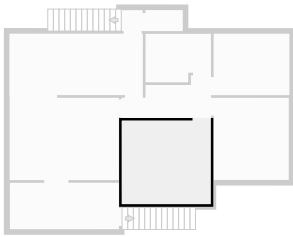

▼ **Vestibule**
1st Floor

WIDTH: 1.67 m • LENGTH: 0.94 m
AREA: 1.56 m² • PERIMETER: 5.21 m

