

17 Woodford WAY

SUBMITTED BY

Ray White Rockhampton Casey
stockers@cqoz.com

CREATED ON

2022-07-18

Floors

1

▼ Ground Floor



▼ **Bathroom**
Ground Floor

WIDTH: 2.98 m • LENGTH: 2.09 m
AREA: 4.83 m² • PERIMETER: 10.12 m

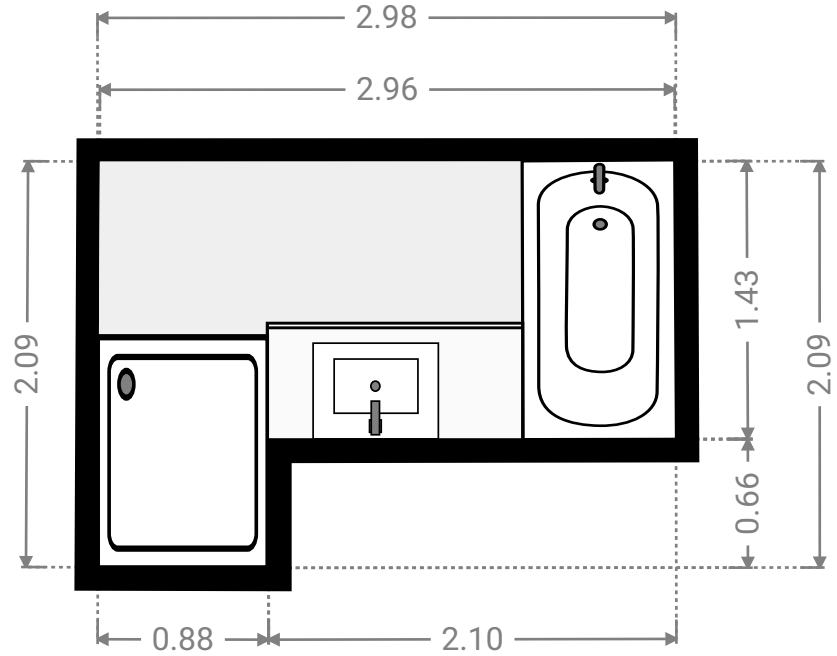

▼ **Bathroom**
Ground Floor

WIDTH: 3.21 m • LENGTH: 2.28 m
AREA: 6.02 m² • PERIMETER: 10.98 m

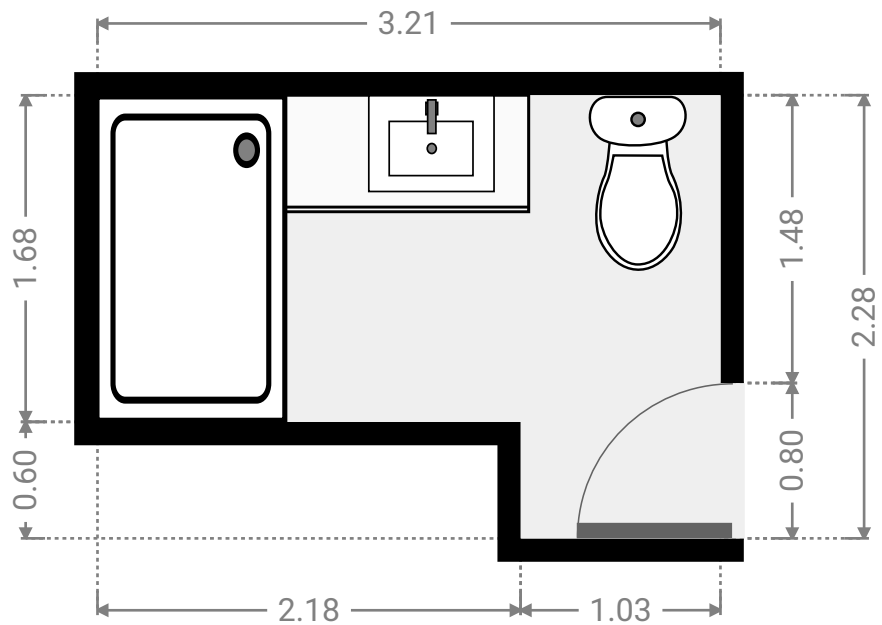
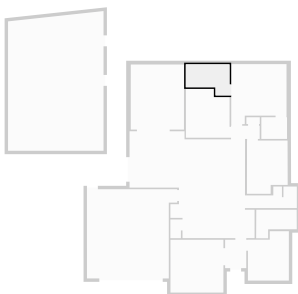

FLOORS: 1

▼ **Bedroom**
Ground Floor

WIDTH: 2.99 m • LENGTH: 3.90 m
AREA: 10.81 m² • PERIMETER: 13.76 m

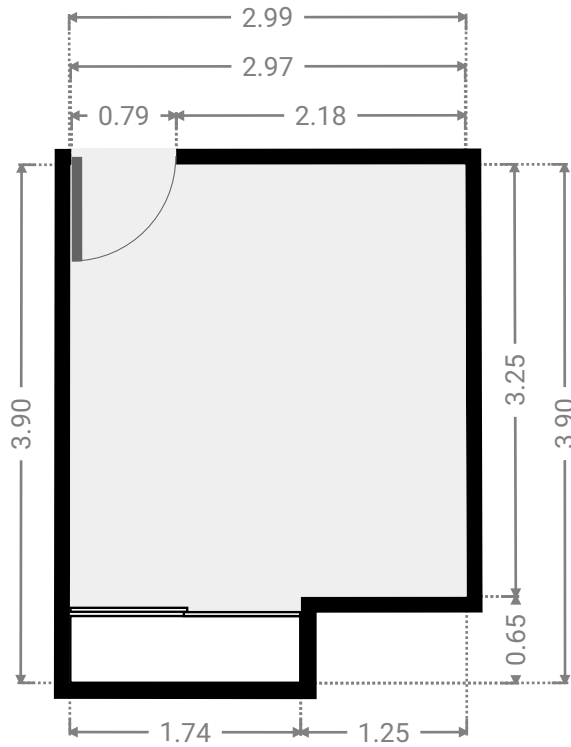
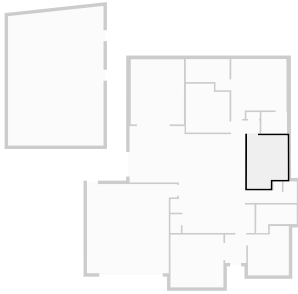

▼ **Bedroom**
Ground Floor

WIDTH: 3.20 m • LENGTH: 3.58 m
AREA: 10.77 m² • PERIMETER: 13.56 m

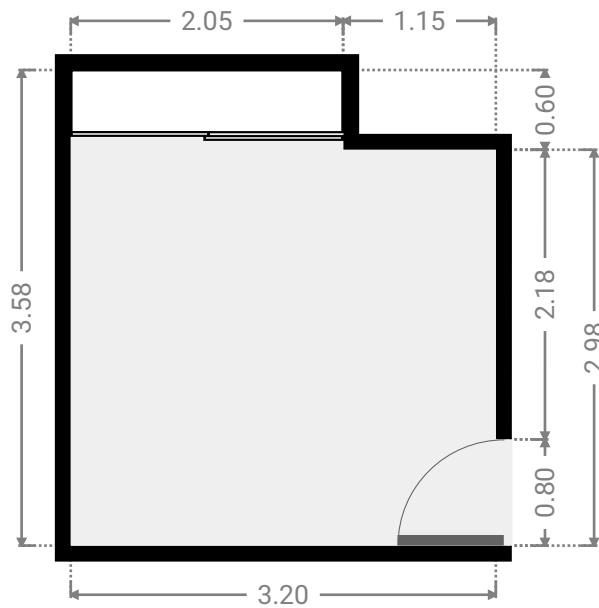
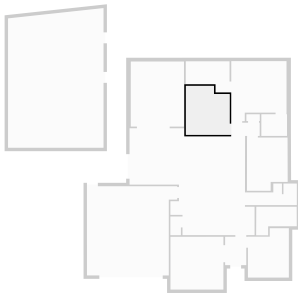

FLOORS: 1

▼ Garage
Ground Floor

WIDTH: 6.62 m • LENGTH: 6.54 m
AREA: 39.84 m² • PERIMETER: 26.32 m

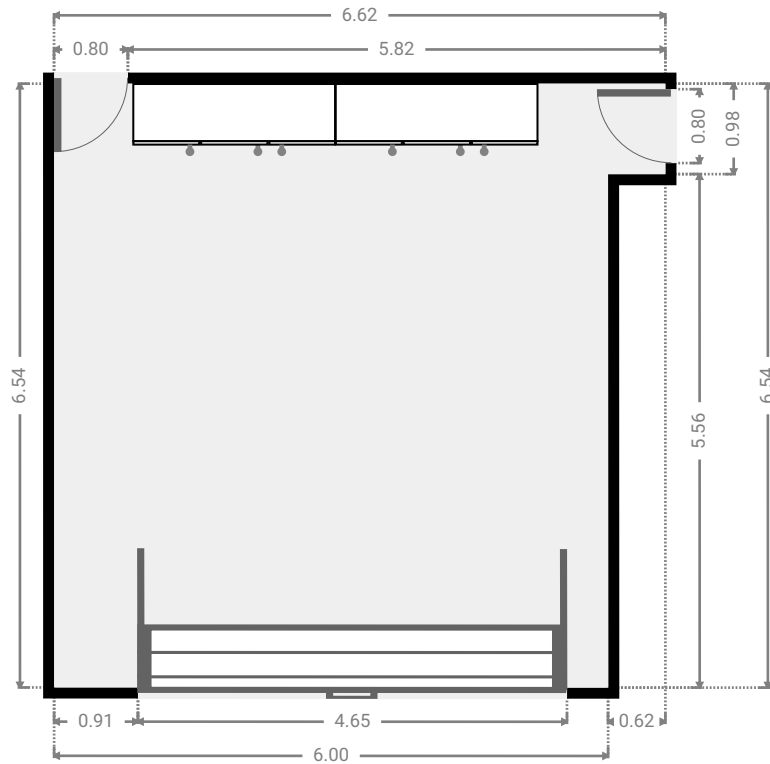
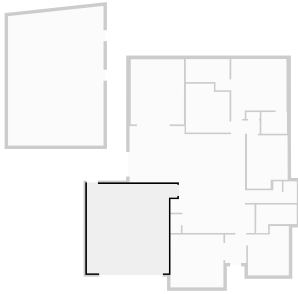

▼ Hall
Ground Floor

WIDTH: 1.55 m • LENGTH: 2.08 m
AREA: 3.22 m² • PERIMETER: 7.26 m

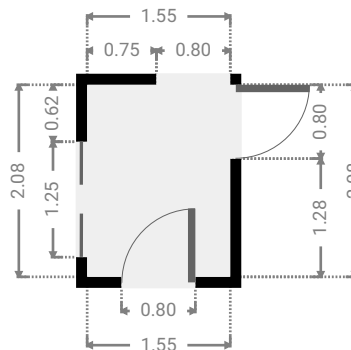
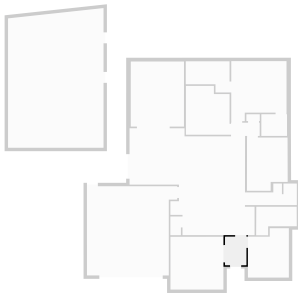

FLOORS: 1

▼ **Hall**
Ground Floor

WIDTH: 2.64 m • LENGTH: 1.58 m
AREA: 2.87 m² • PERIMETER: 8.44 m

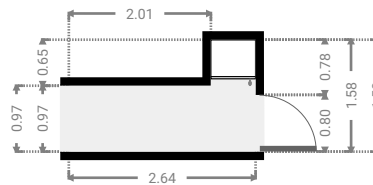
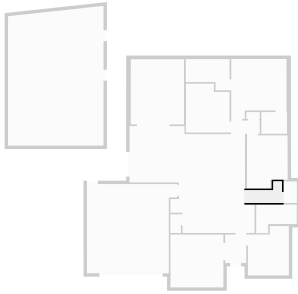

▼ **Kitchen**
Ground Floor

WIDTH: 9.54 m • LENGTH: 8.24 m
AREA: 54.06 m² • PERIMETER: 39.40 m

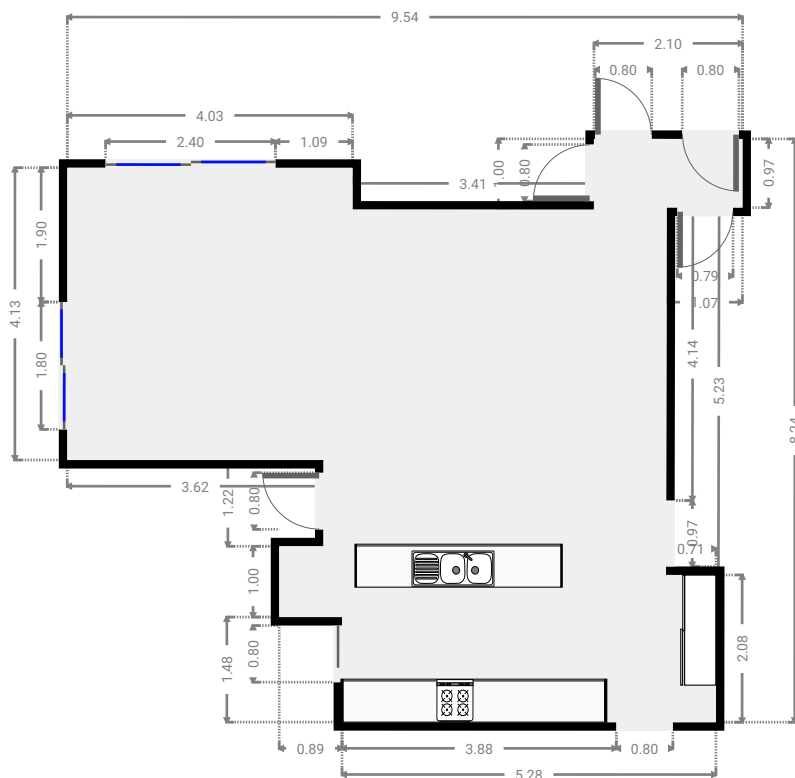
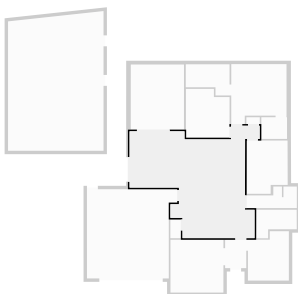

FLOORS: 1

▼ Closet
Ground Floor

WIDTH: 0.77 m • LENGTH: 1.37 m
AREA: 1.05 m² • PERIMETER: 4.28 m

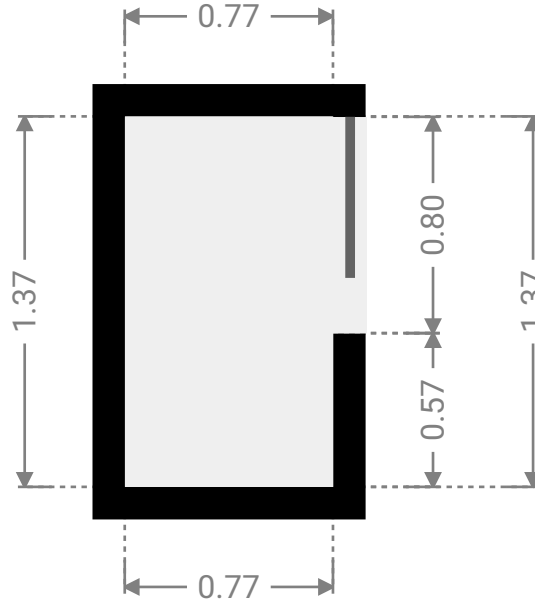
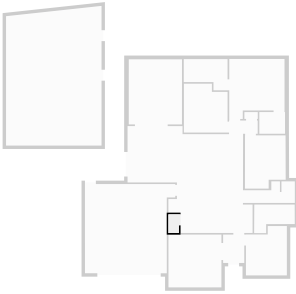

▼ Closet
Ground Floor

WIDTH: 0.98 m • LENGTH: 0.50 m
AREA: 0.49 m² • PERIMETER: 2.96 m

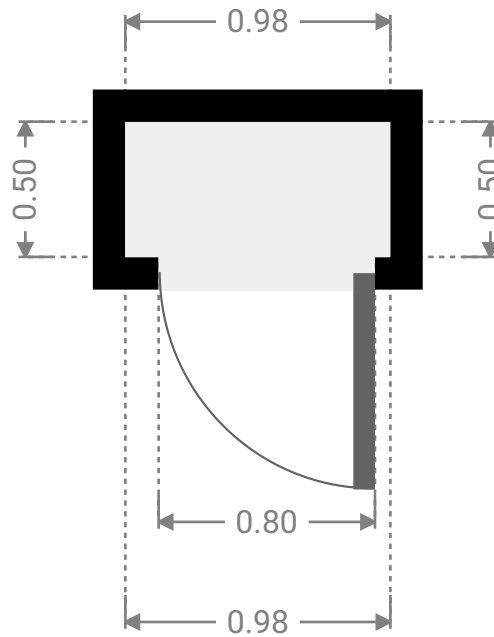
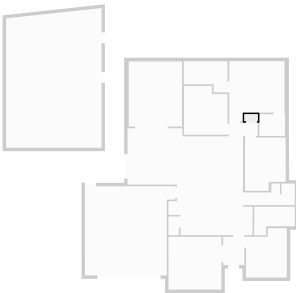

▼ Living Room
Ground Floor

WIDTH: 3.88 m • LENGTH: 3.87 m
AREA: 15.02 m² • PERIMETER: 15.50 m

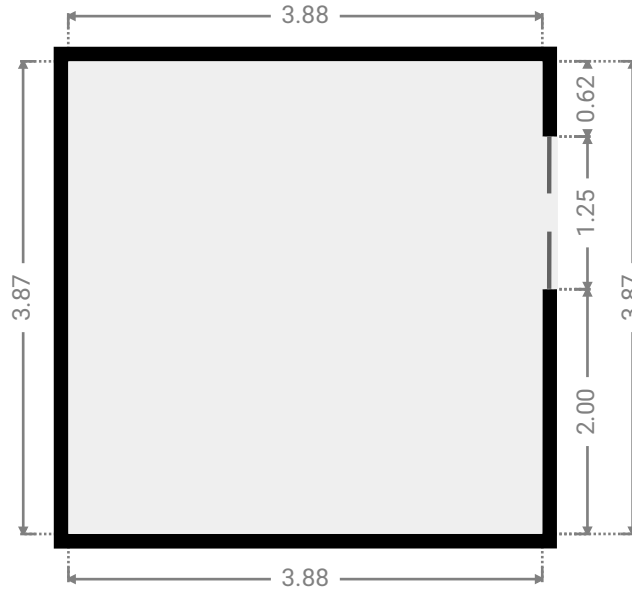

▼ Living Room
Ground Floor

WIDTH: 3.90 m • LENGTH: 4.77 m
AREA: 18.61 m² • PERIMETER: 17.34 m

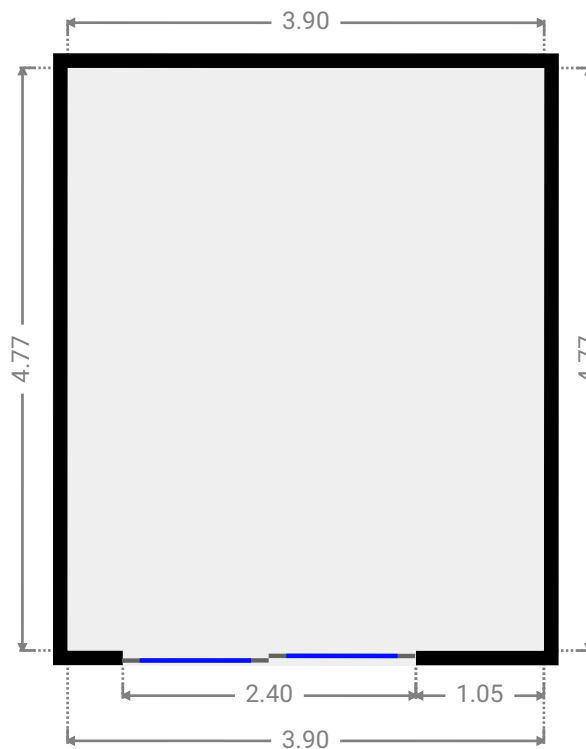
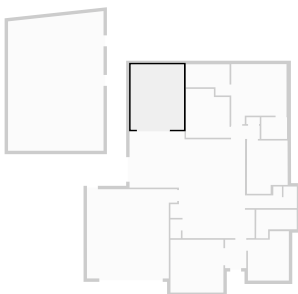

FLOORS: 1

▼ **Other**
Ground Floor

WIDTH: 7.00 m • LENGTH: 10.24 m
AREA: 69.04 m² • PERIMETER: 33.77 m

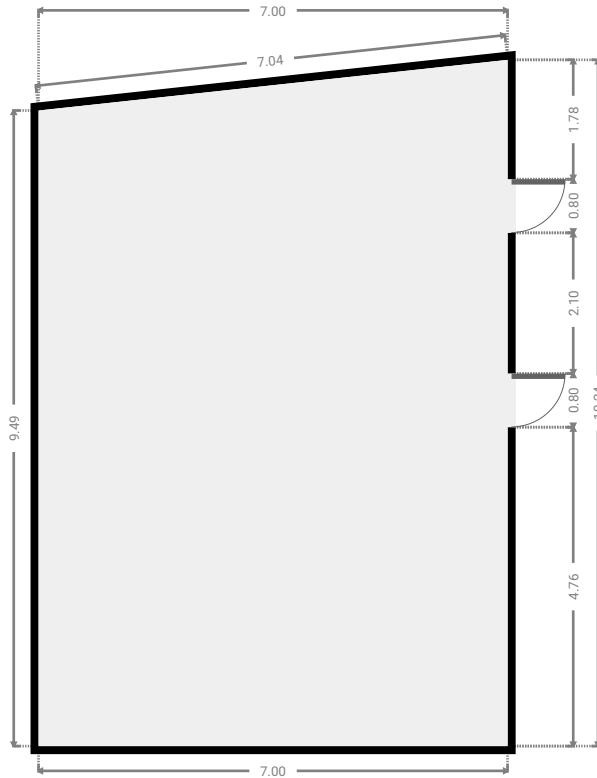
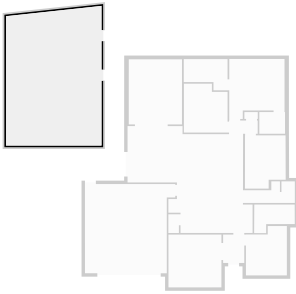

▼ **Primary Bedroom**
Ground Floor

WIDTH: 3.00 m • LENGTH: 3.62 m
AREA: 9.87 m² • PERIMETER: 13.24 m

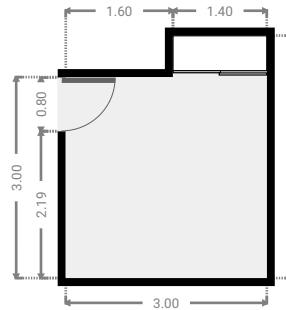

FLOORS: 1

▼ **Primary Bedroom**
Ground Floor

WIDTH: 4.05 m • LENGTH: 4.40 m
AREA: 15.91 m² • PERIMETER: 16.90 m

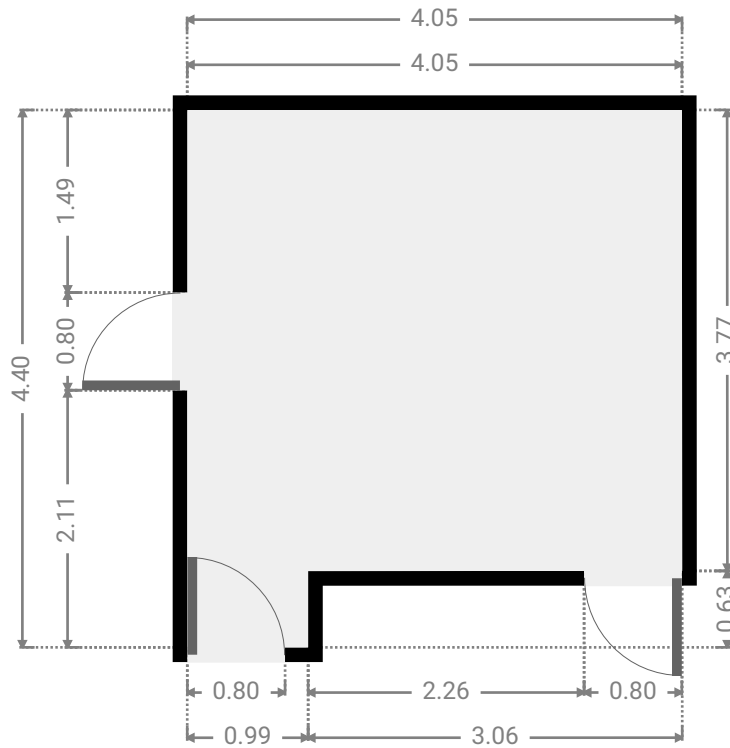
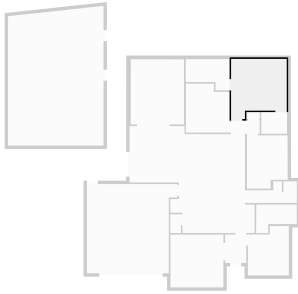

▼ **Closet**
Ground Floor

WIDTH: 1.88 m • LENGTH: 1.59 m
AREA: 2.99 m² • PERIMETER: 6.94 m

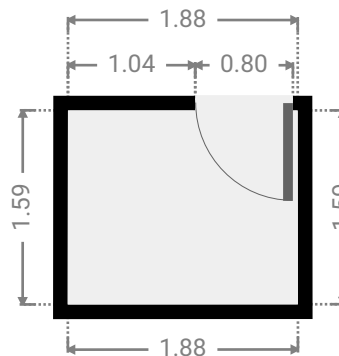
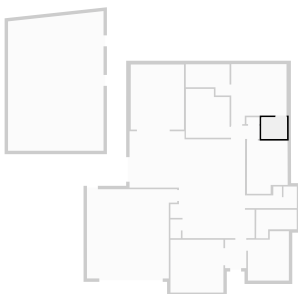

▼ Toilet
Ground Floor

WIDTH: 0.98 m • LENGTH: 1.58 m
AREA: 1.55 m² • PERIMETER: 5.12 m

