

17 Quinn Street

SUBMITTED BY

Ray White Rockhampton Casey
stockers@cqoz.com

CREATED ON

2022-06-29

Floors

2

▼ Ground Floor

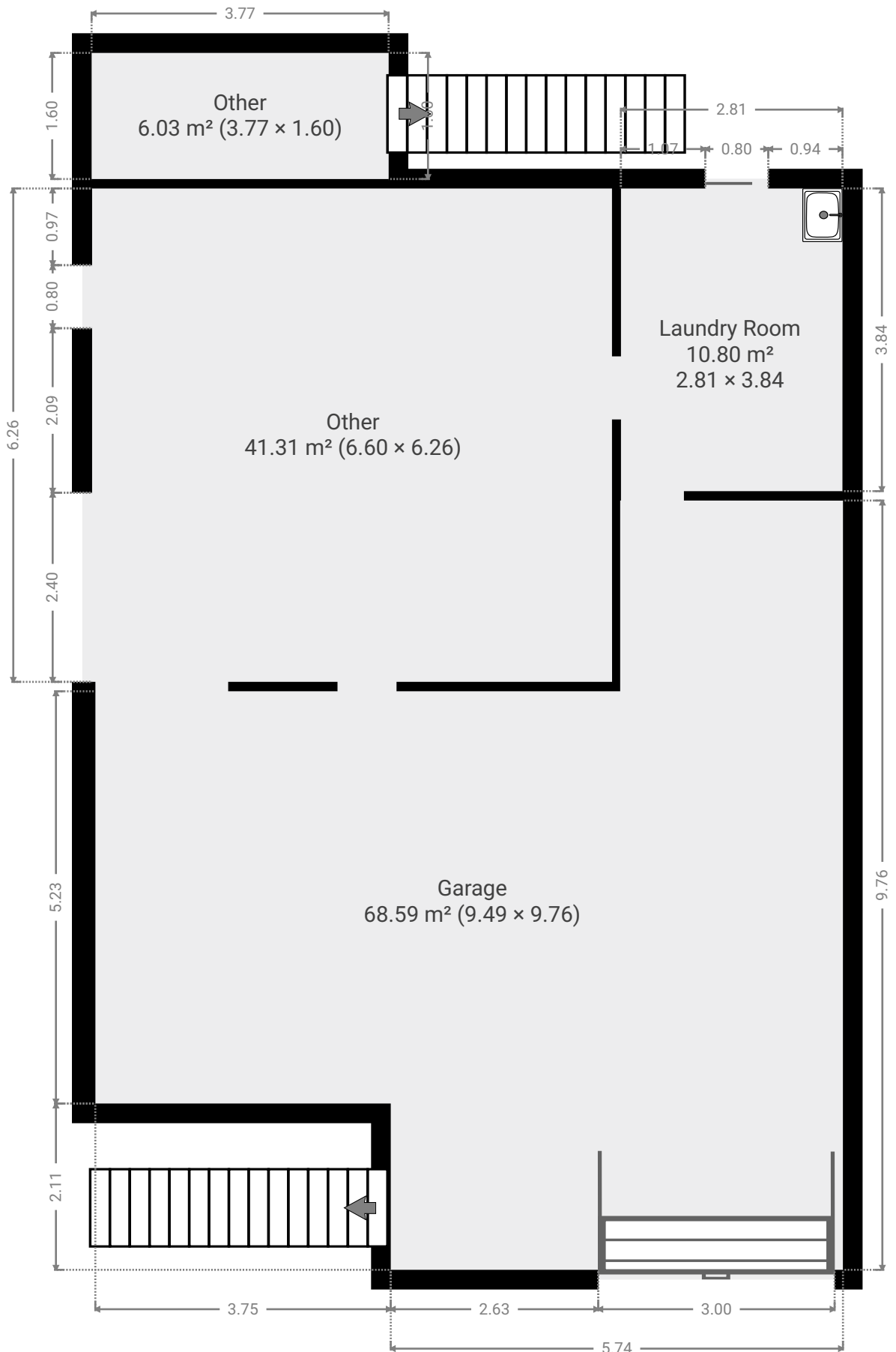

▼ **Garage**
Ground Floor

WIDTH: 9.49 m • LENGTH: 9.76 m
AREA: 68.59 m² • PERIMETER: 38.50 m

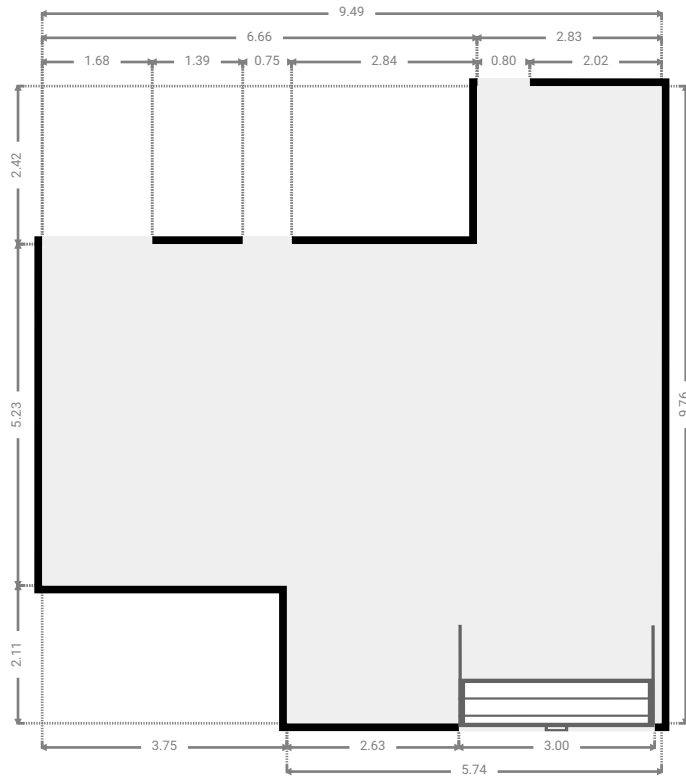
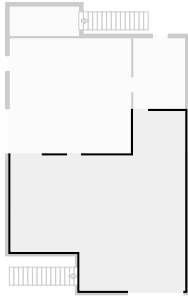

▼ **Laundry Room**
Ground Floor

WIDTH: 2.81 m • LENGTH: 3.84 m
AREA: 10.80 m² • PERIMETER: 13.31 m

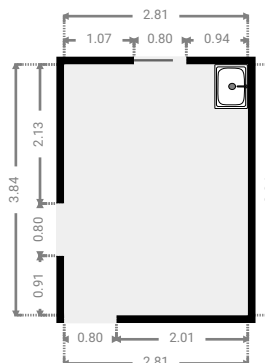
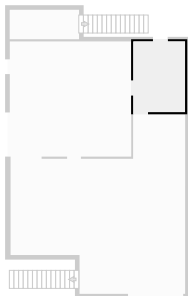

▼ Other
Ground Floor

WIDTH: 6.60 m • LENGTH: 6.26 m
AREA: 41.31 m² • PERIMETER: 25.72 m

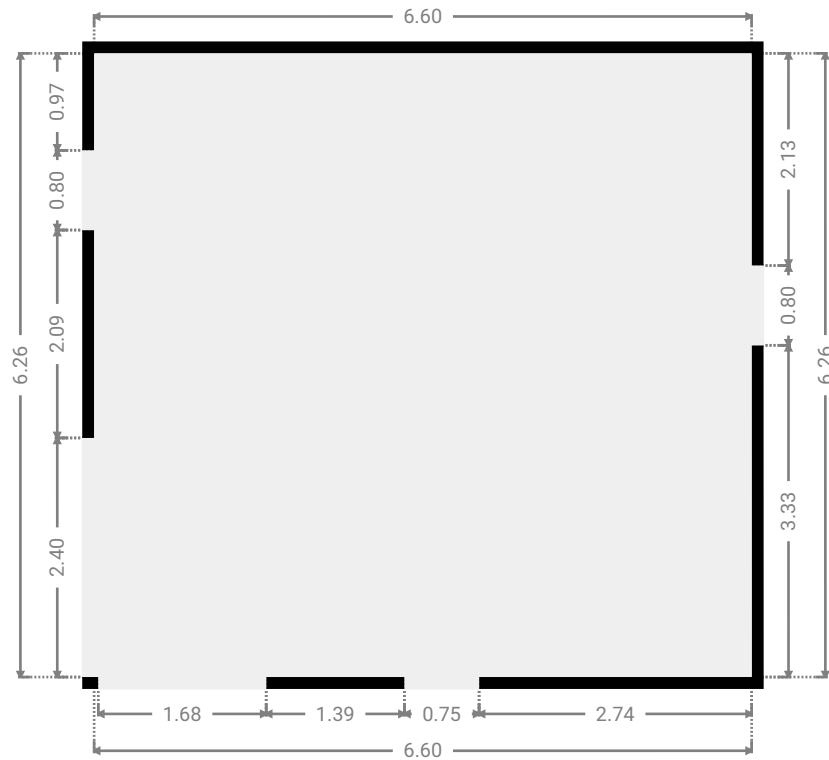
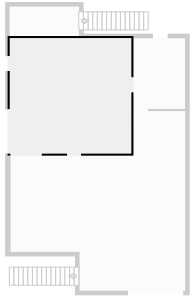

▼ Other
Ground Floor

WIDTH: 3.77 m • LENGTH: 1.60 m
AREA: 6.03 m² • PERIMETER: 10.74 m

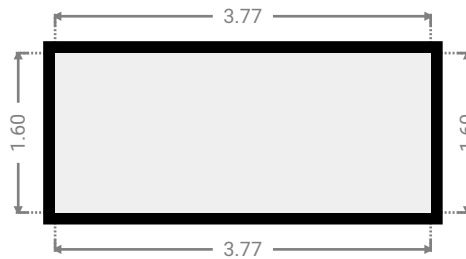
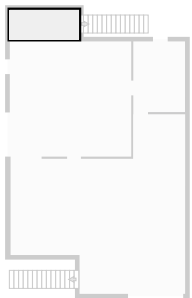

▼ 1st Floor

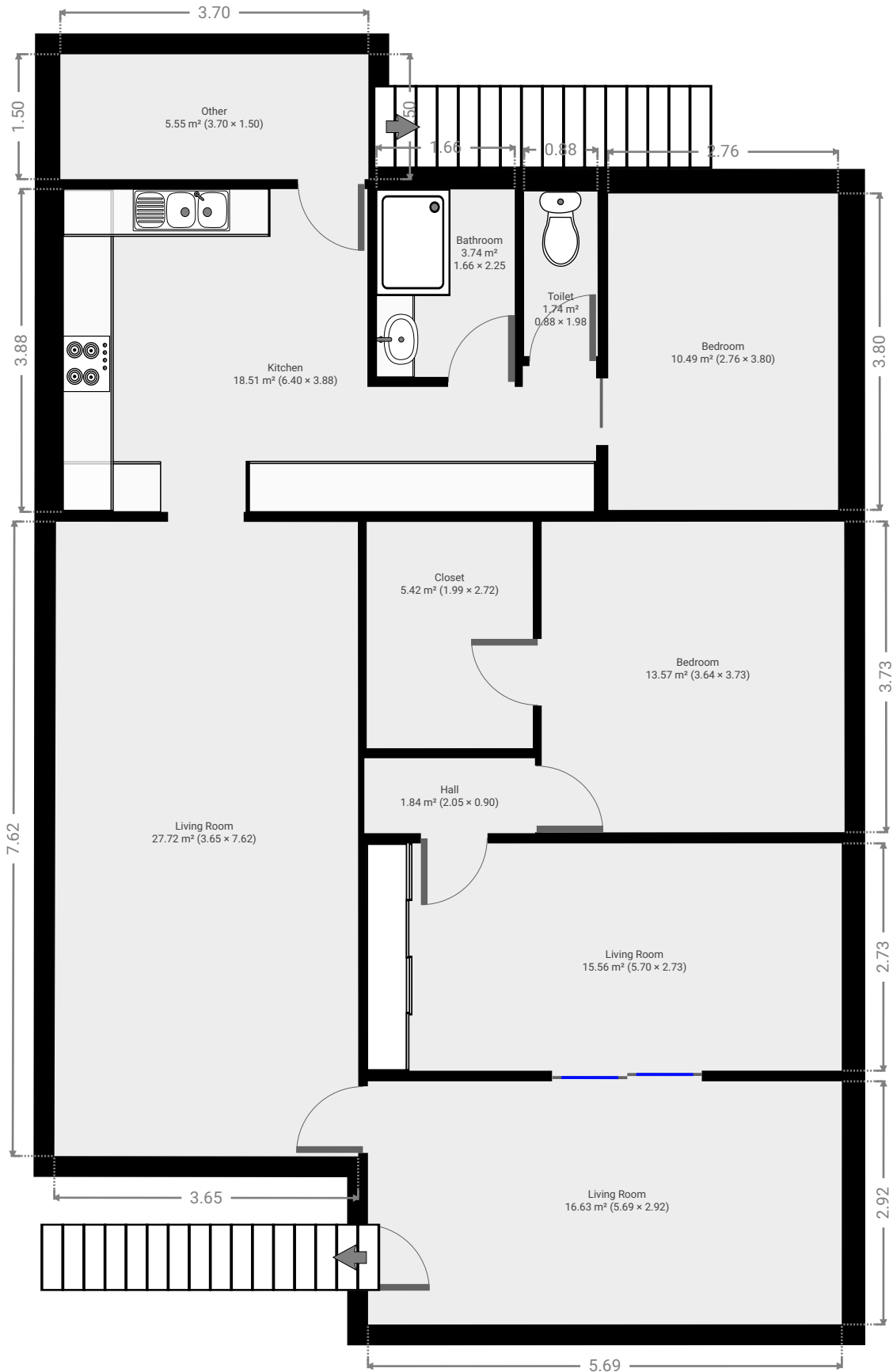

▼ **Bathroom**
1st Floor

WIDTH: 1.66 m • LENGTH: 2.25 m
AREA: 3.74 m² • PERIMETER: 7.82 m

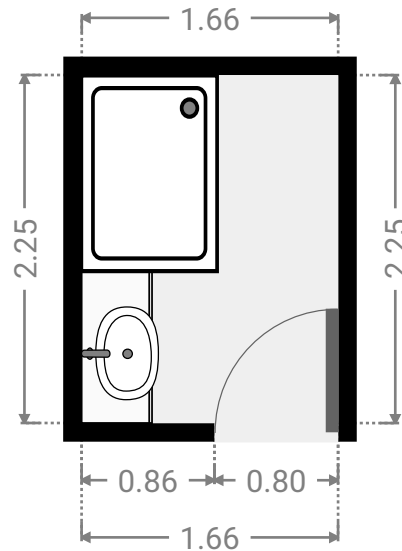
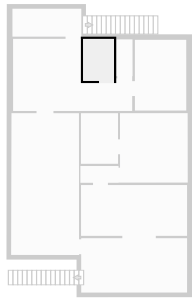

▼ **Bedroom**
1st Floor

WIDTH: 3.64 m • LENGTH: 3.73 m
AREA: 13.57 m² • PERIMETER: 14.74 m

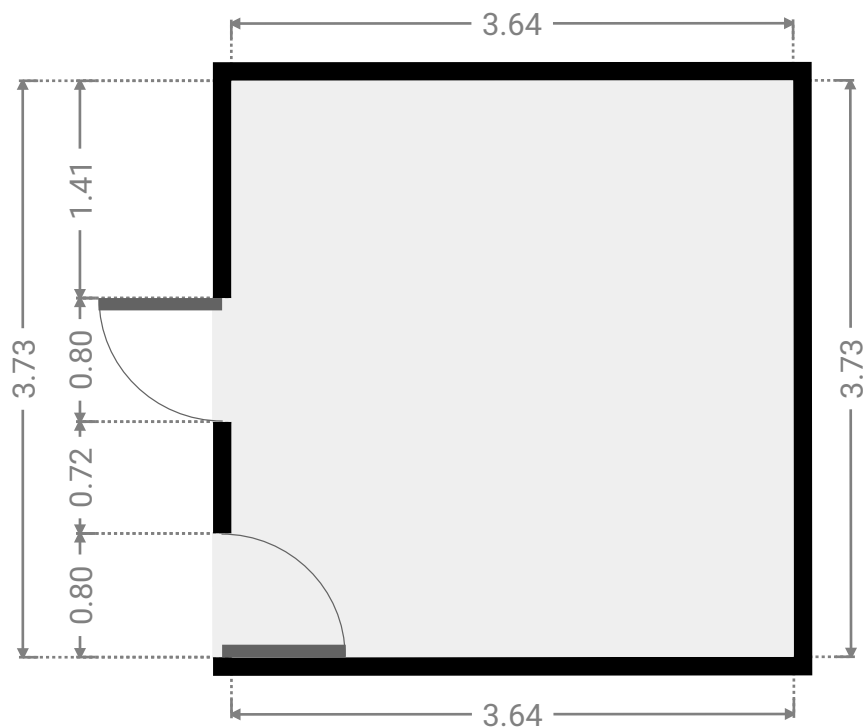
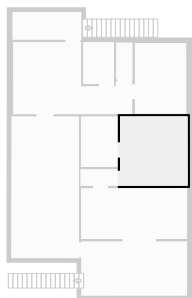

▼ **Closet**
1st Floor

WIDTH: 1.99 m • LENGTH: 2.72 m
AREA: 5.42 m² • PERIMETER: 9.43 m

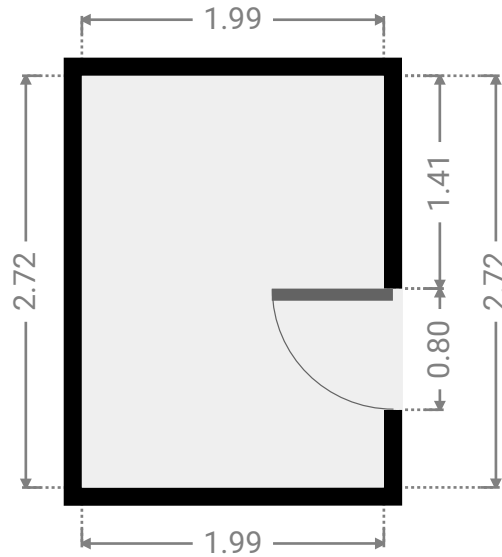
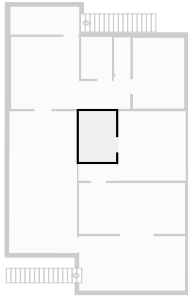

▼ **Bedroom**
1st Floor

WIDTH: 2.76 m • LENGTH: 3.80 m
AREA: 10.49 m² • PERIMETER: 13.12 m

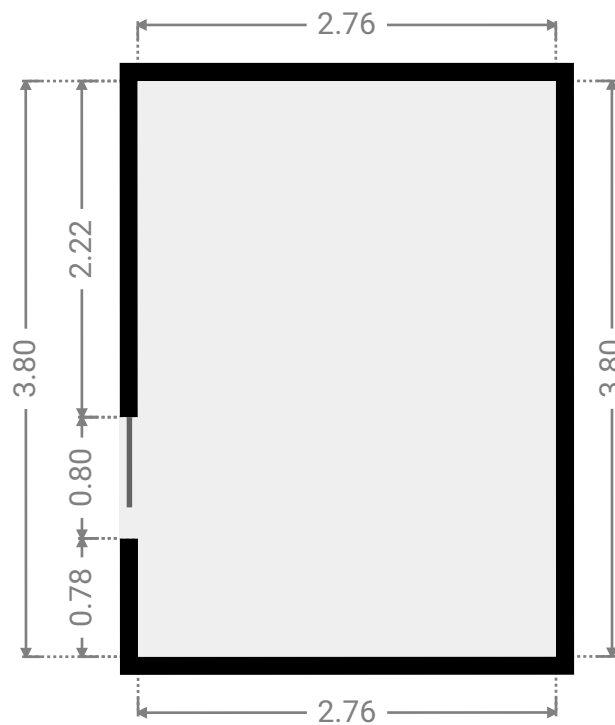
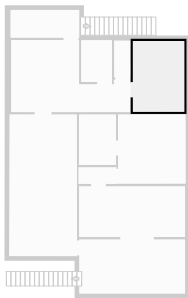

▼ **Hall**
1st Floor

WIDTH: 2.05 m • LENGTH: 0.90 m
AREA: 1.84 m² • PERIMETER: 5.90 m

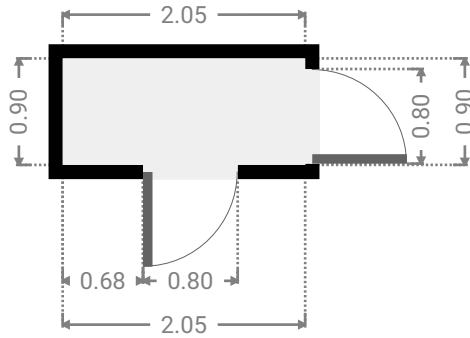
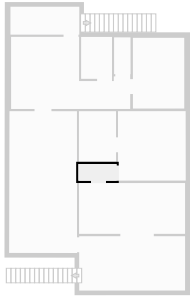

▼ **Kitchen**
1st Floor

WIDTH: 6.40 m • LENGTH: 3.88 m
AREA: 18.51 m² • PERIMETER: 21.06 m

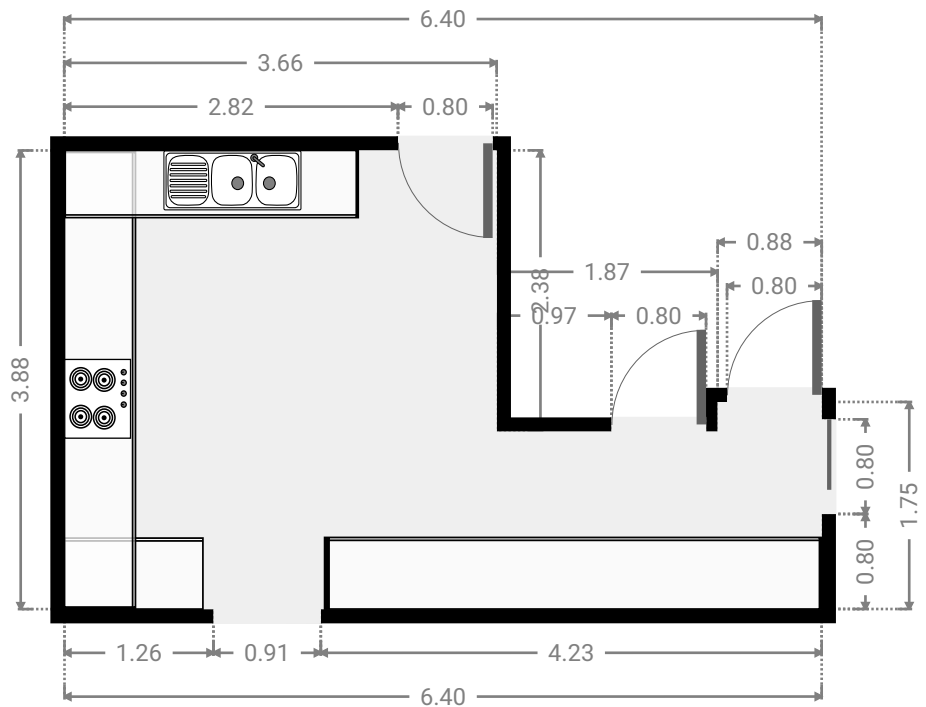
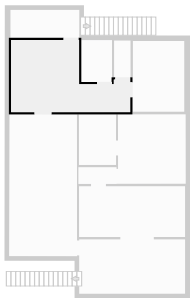

▼ Living Room
1st Floor

WIDTH: 5.69 m • LENGTH: 2.92 m
AREA: 16.63 m² • PERIMETER: 17.23 m

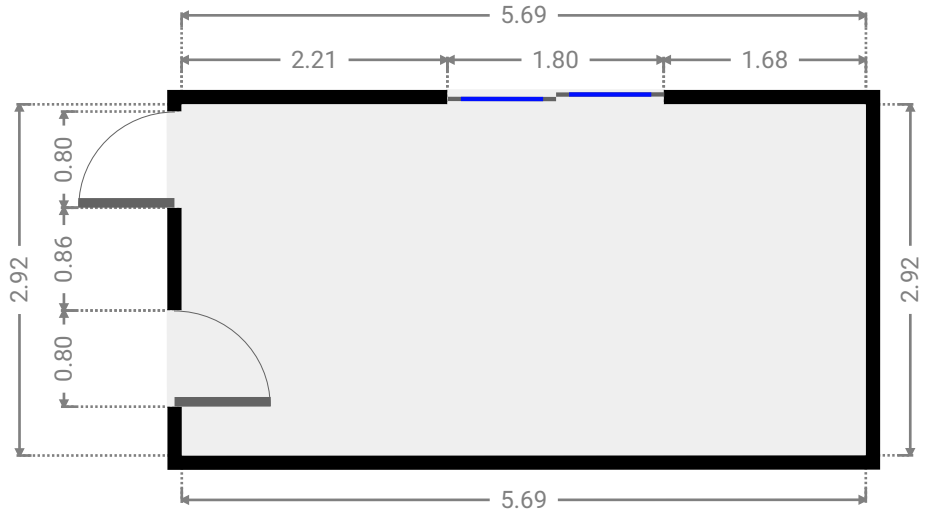
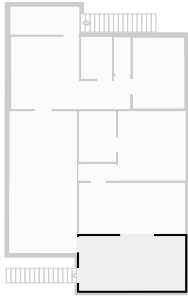

▼ Living Room
1st Floor

WIDTH: 5.70 m • LENGTH: 2.73 m
AREA: 15.56 m² • PERIMETER: 16.86 m

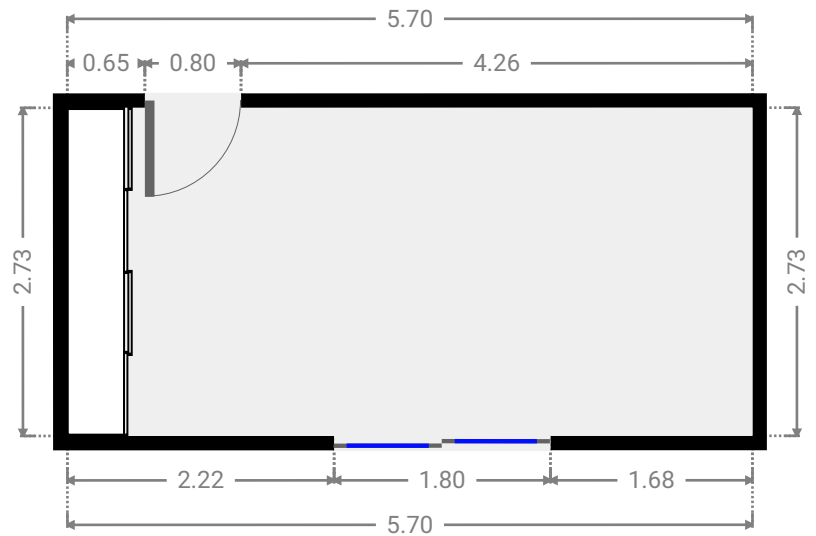
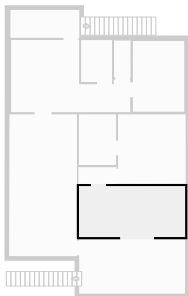

▼ **Living Room**
1st Floor

WIDTH: 3.65 m • LENGTH: 7.62 m
AREA: 27.72 m² • PERIMETER: 22.52 m

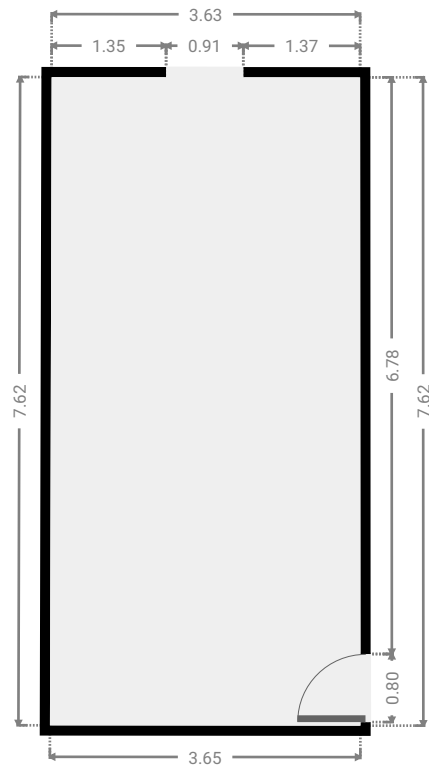
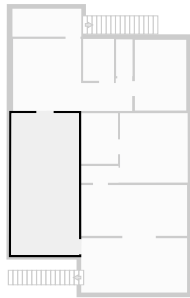

▼ **Other**
1st Floor

WIDTH: 3.70 m • LENGTH: 1.50 m
AREA: 5.55 m² • PERIMETER: 10.40 m

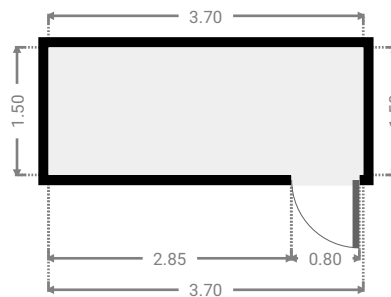
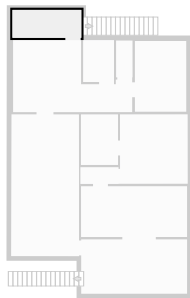

▼ Toilet
1st Floor

WIDTH: 0.88 m • LENGTH: 1.98 m
AREA: 1.74 m² • PERIMETER: 5.72 m

