

# 17 Laura Close

**SUBMITTED BY**

Ray White Rockhampton Casey  
stockers@cqoz.com

---

**CREATED ON**

2022-03-22

---

**Floors**

1

---

## ▼ Ground Floor



# 17 Laura Close

FLOORS: 1

## ▼ Bedroom Ground Floor

WIDTH: 4.14 m • LENGTH: 3.58 m  
AREA: 14.82 m<sup>2</sup> • PERIMETER: 15.44 m

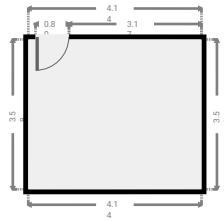

## ▼ Other Ground Floor

WIDTH: 21.00 m • LENGTH: 8.00 m  
AREA: 168.00 m<sup>2</sup> • PERIMETER: 58.00 m



# 17 Laura Close

FLOORS: 1

## ▼ Other Ground Floor

WIDTH: 13.10 m • LENGTH: 7.00 m  
AREA: 91.69 m<sup>2</sup> • PERIMETER: 40.20 m

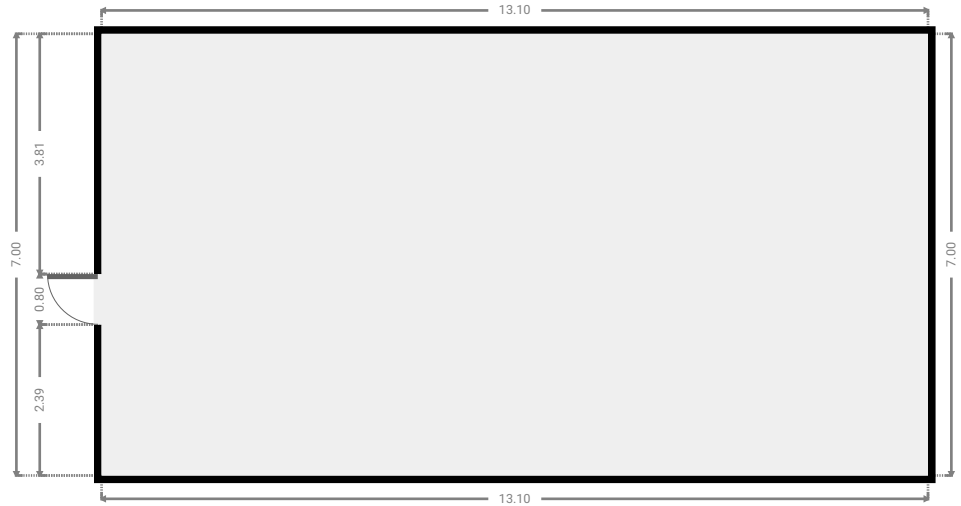
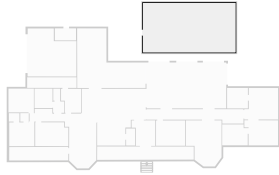

## ▼ Bathroom Ground Floor

WIDTH: 3.00 m • LENGTH: 1.70 m  
AREA: 5.10 m<sup>2</sup> • PERIMETER: 9.40 m

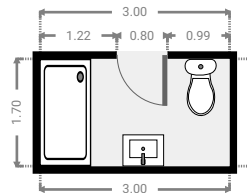

FLOORS: 1

## ▼ Other Ground Floor

WIDTH: 9.70 m • LENGTH: 8.45 m  
AREA: 54.99 m<sup>2</sup> • PERIMETER: 36.29 m

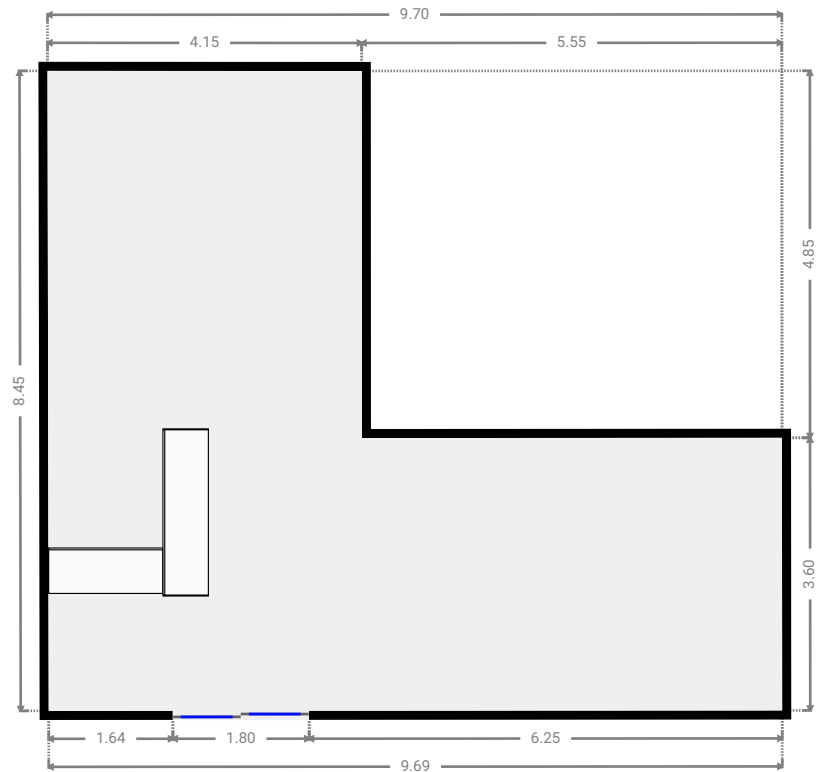

## ▼ Garage Ground Floor

WIDTH: 6.92 m • LENGTH: 6.81 m  
AREA: 41.25 m<sup>2</sup> • PERIMETER: 27.43 m

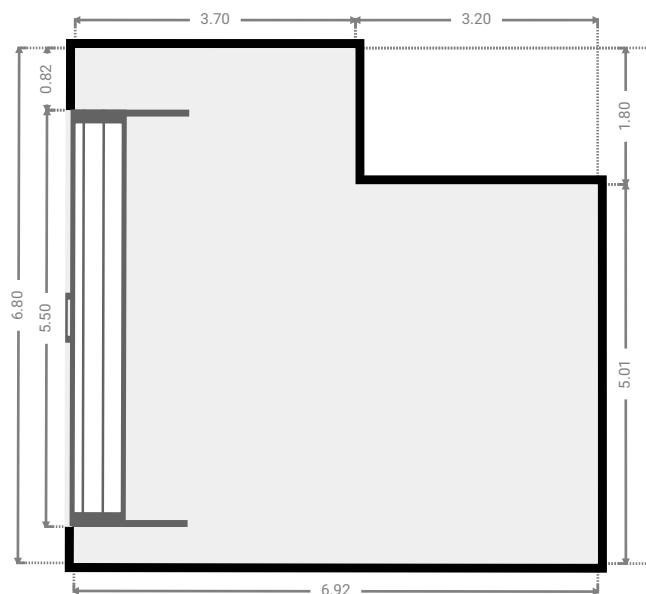
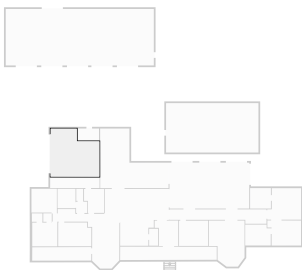

## ▼ Hallway Ground Floor

WIDTH: 7.00 m • LENGTH: 1.50 m  
AREA: 10.49 m<sup>2</sup> • PERIMETER: 17.00 m

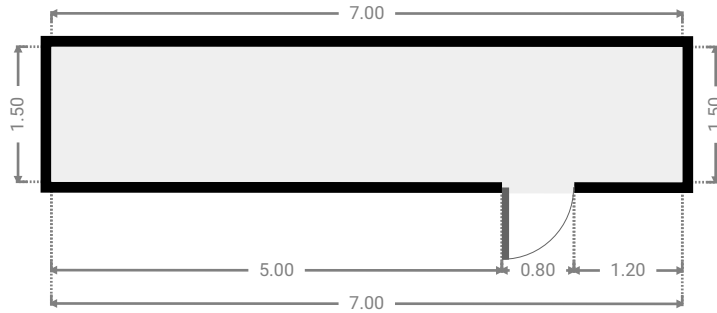

## ▼ Other Ground Floor

WIDTH: 8.39 m • LENGTH: 1.91 m  
AREA: 15.95 m<sup>2</sup> • PERIMETER: 20.57 m

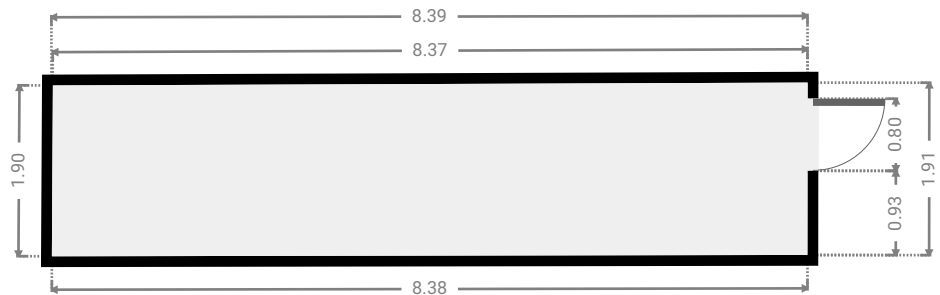

# 17 Laura Close

FLOORS: 1

## ▼ Other Ground Floor

WIDTH: 13.70 m • LENGTH: 1.90 m  
AREA: 25.60 m<sup>2</sup> • PERIMETER: 31.13 m

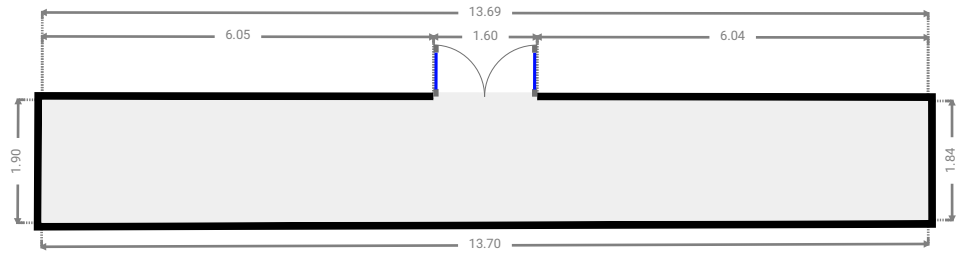

## ▼ Bathroom Ground Floor

WIDTH: 2.95 m • LENGTH: 2.90 m  
AREA: 8.56 m<sup>2</sup> • PERIMETER: 11.70 m

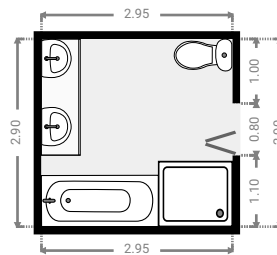
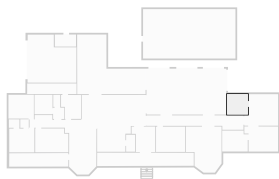

FLOORS: 1

▼ **Bedroom**  
Ground Floor

WIDTH: 4.77 m • LENGTH: 3.56 m  
AREA: 15.42 m<sup>2</sup> • PERIMETER: 16.64 m

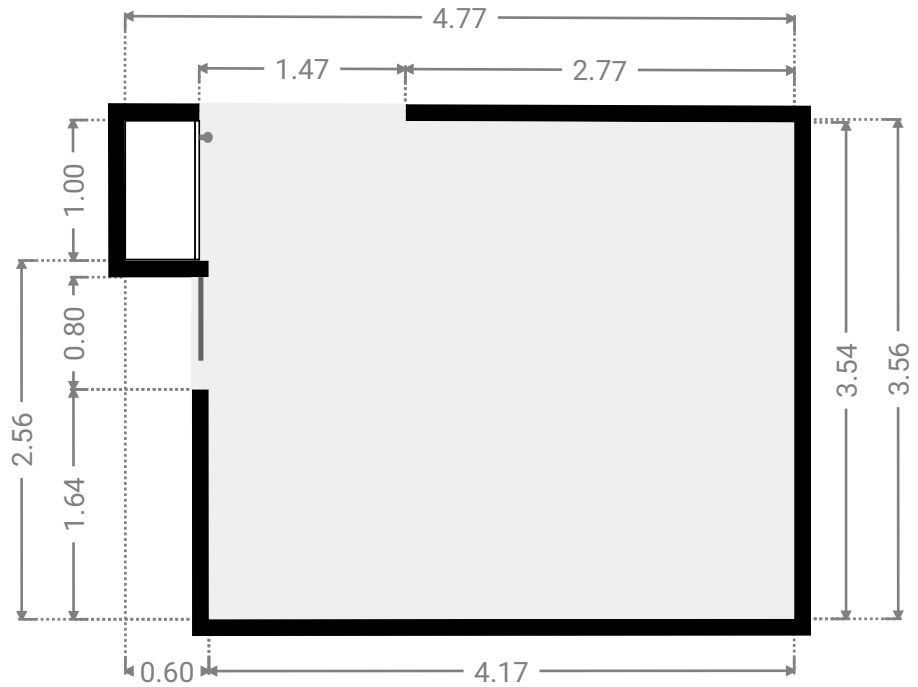

▼ **Closet**  
Ground Floor

WIDTH: 3.62 m • LENGTH: 2.96 m  
AREA: 10.40 m<sup>2</sup> • PERIMETER: 13.16 m

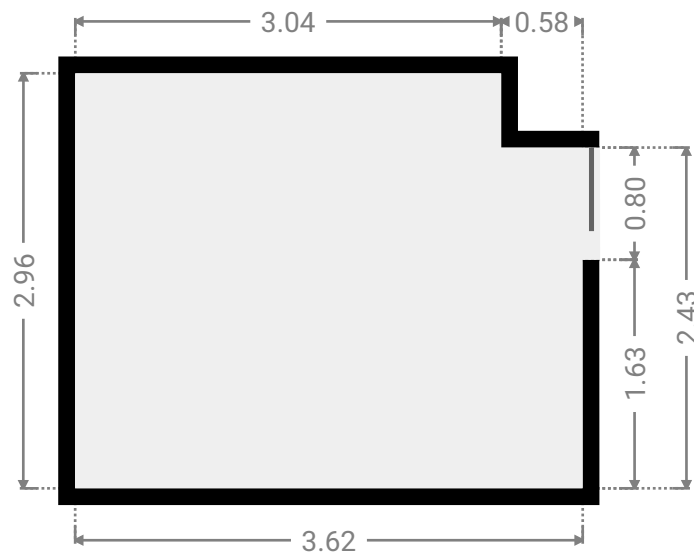



# 17 Laura Close

FLOORS: 1



## ▼ Primary Bedroom Ground Floor

WIDTH: 4.80 m • LENGTH: 4.46 m  
AREA: 19.49 m<sup>2</sup> • PERIMETER: 18.52 m

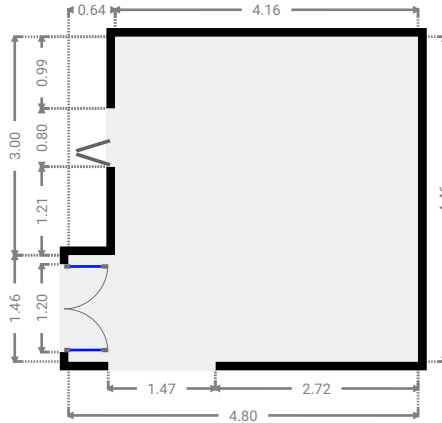

## ▼ Living Room Ground Floor

WIDTH: 11.30 m • LENGTH: 6.50 m  
AREA: 73.47 m<sup>2</sup> • PERIMETER: 35.61 m

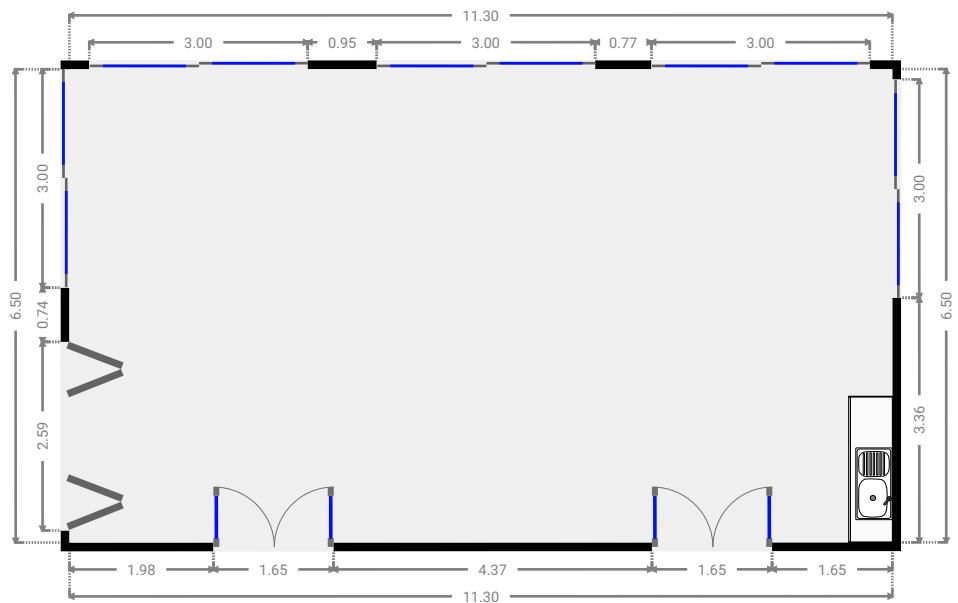
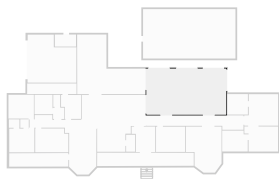

THIS FLOORPLAN IS PROVIDED WITHOUT WARRANTY OF ANY KIND. SENSOPIA DISCLAIMS ANY WARRANTY INCLUDING, WITHOUT LIMITATION, SATISFACTORY QUALITY OR ACCURACY OF DIMENSIONS.

FLOORS: 1

▼ Living Room  
Ground Floor

WIDTH: 5.04 m • LENGTH: 6.53 m  
AREA: 28.11 m<sup>2</sup> • PERIMETER: 21.86 m

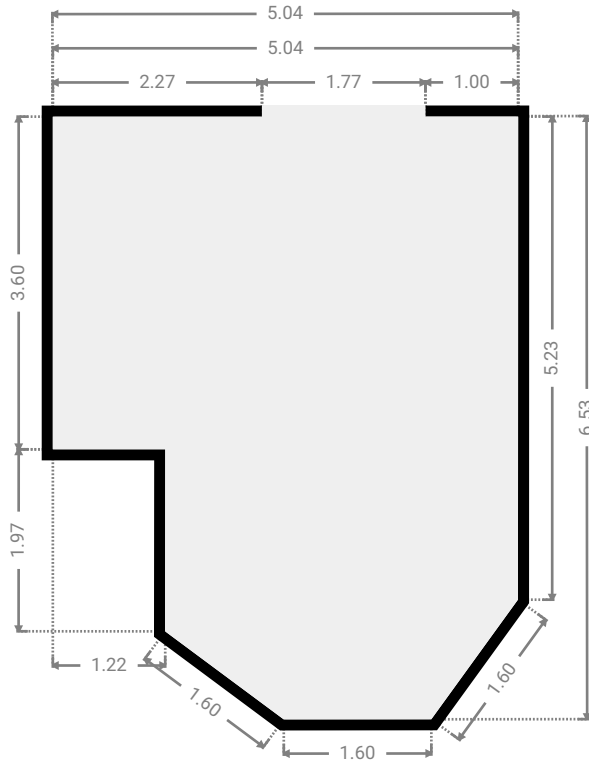

▼ Bedroom  
Ground Floor

WIDTH: 3.56 m • LENGTH: 3.37 m  
AREA: 12.00 m<sup>2</sup> • PERIMETER: 13.86 m

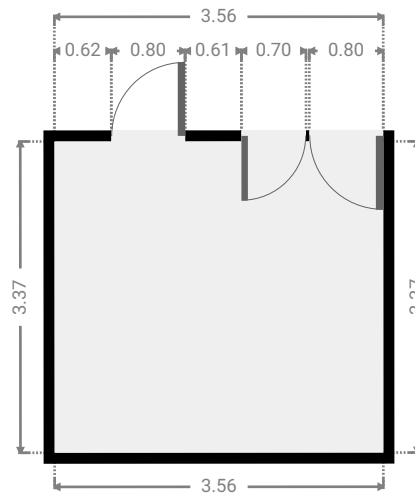

# 17 Laura Close

FLOORS: 1

## ▼ Hall Ground Floor

WIDTH: 13.74 m • LENGTH: 2.04 m  
AREA: 21.99 m<sup>2</sup> • PERIMETER: 31.56 m

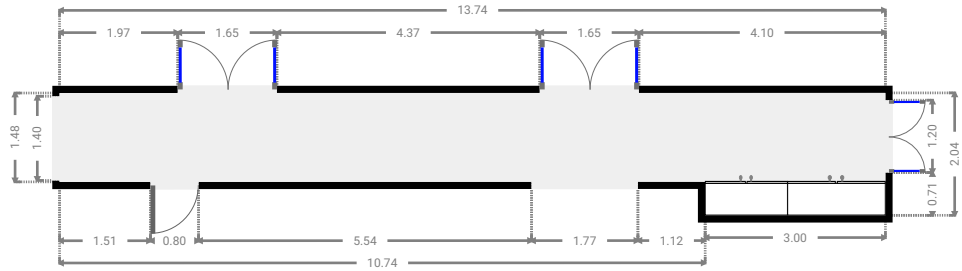

## ▼ Living Room Ground Floor

WIDTH: 3.35 m • LENGTH: 3.62 m  
AREA: 10.59 m<sup>2</sup> • PERIMETER: 13.94 m

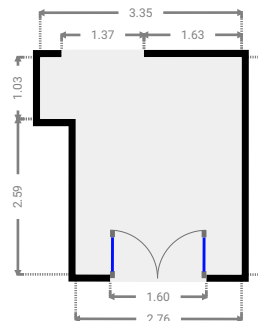
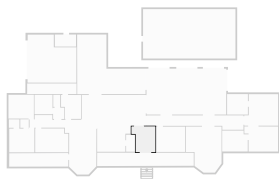

FLOORS: 1

## ▼ Closet Ground Floor

WIDTH: 1.26 m • LENGTH: 2.40 m  
AREA: 3.02 m<sup>2</sup> • PERIMETER: 7.32 m

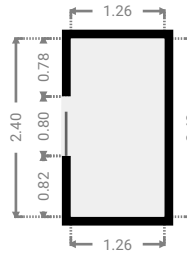

## ▼ Kitchen Ground Floor

WIDTH: 9.09 m • LENGTH: 8.06 m  
AREA: 54.65 m<sup>2</sup> • PERIMETER: 33.33 m

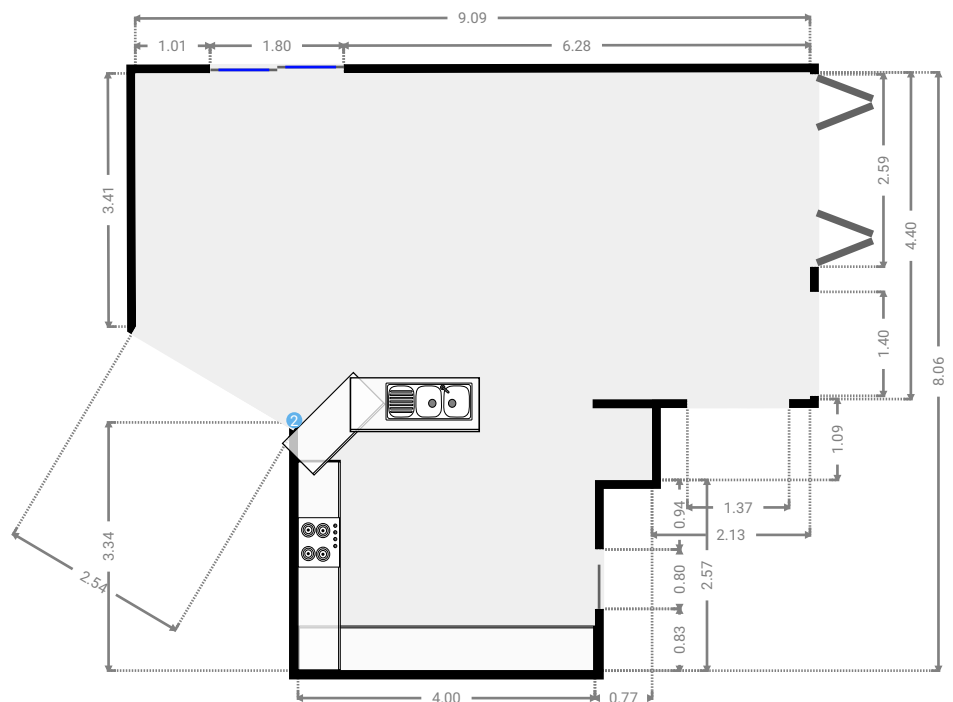
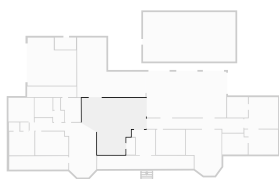

## ▼ Living Room Ground Floor

WIDTH: 4.47 m • LENGTH: 7.77 m  
AREA: 28.46 m<sup>2</sup> • PERIMETER: 22.22 m

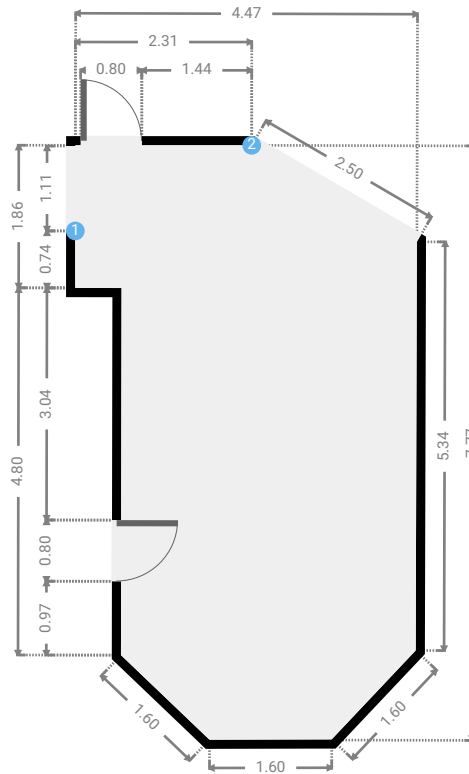
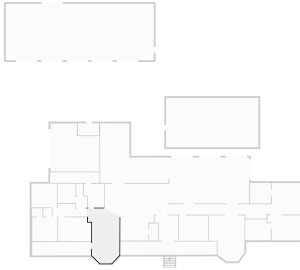

## ▼ Living Room/Ground Floor

### 2 OPENING

Height  
0.00 m



# 17 Laura Close

FLOORS: 1

## ▼ Laundry Room Ground Floor

WIDTH: 2.84 m • LENGTH: 3.39 m  
AREA: 8.67 m<sup>2</sup> • PERIMETER: 12.45 m

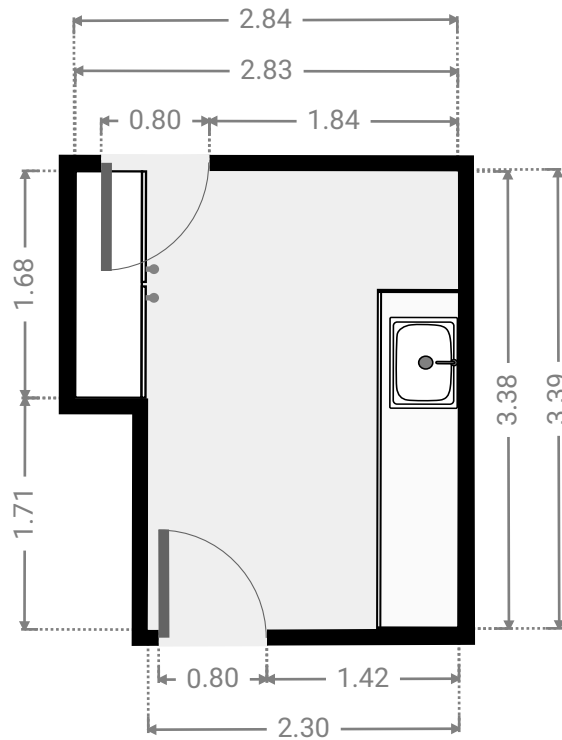
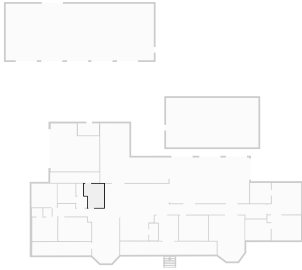

## ▼ Bathroom Ground Floor

WIDTH: 2.55 m • LENGTH: 2.75 m  
AREA: 7.01 m<sup>2</sup> • PERIMETER: 10.60 m

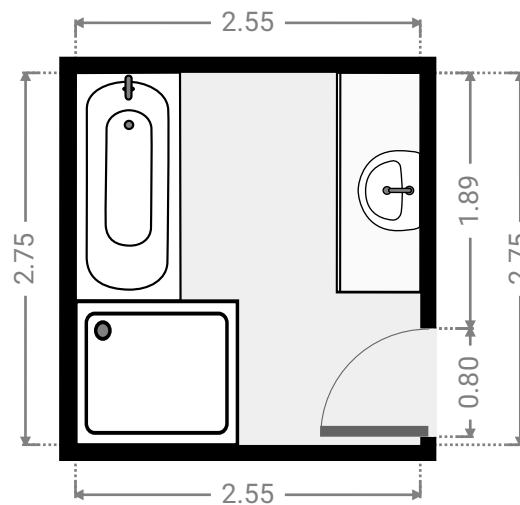

## ▼ Toilet Ground Floor

WIDTH: 0.98 m • LENGTH: 1.70 m  
AREA: 1.67 m<sup>2</sup> • PERIMETER: 5.36 m

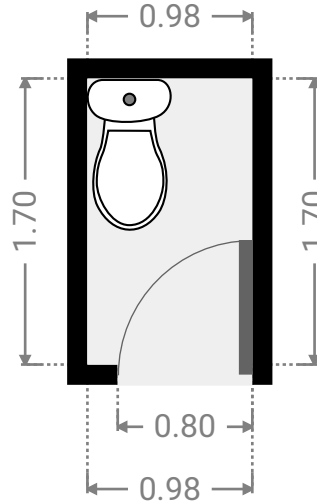

## ▼ Other Ground Floor

WIDTH: 1.58 m • LENGTH: 1.60 m  
AREA: 2.51 m<sup>2</sup> • PERIMETER: 6.34 m

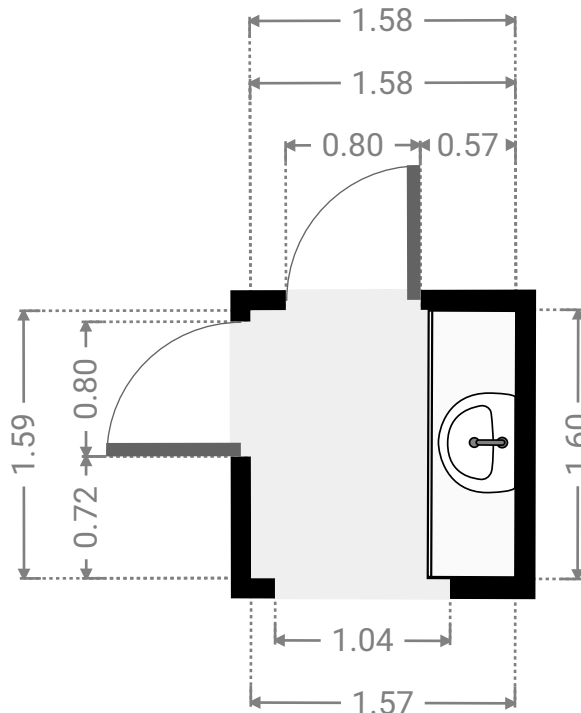
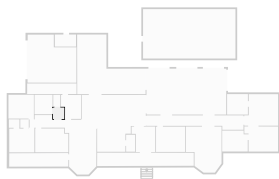

FLOORS: 1

▼ **Bedroom**  
Ground Floor

WIDTH: 4.70 m • LENGTH: 3.37 m  
AREA: 15.39 m<sup>2</sup> • PERIMETER: 16.14 m

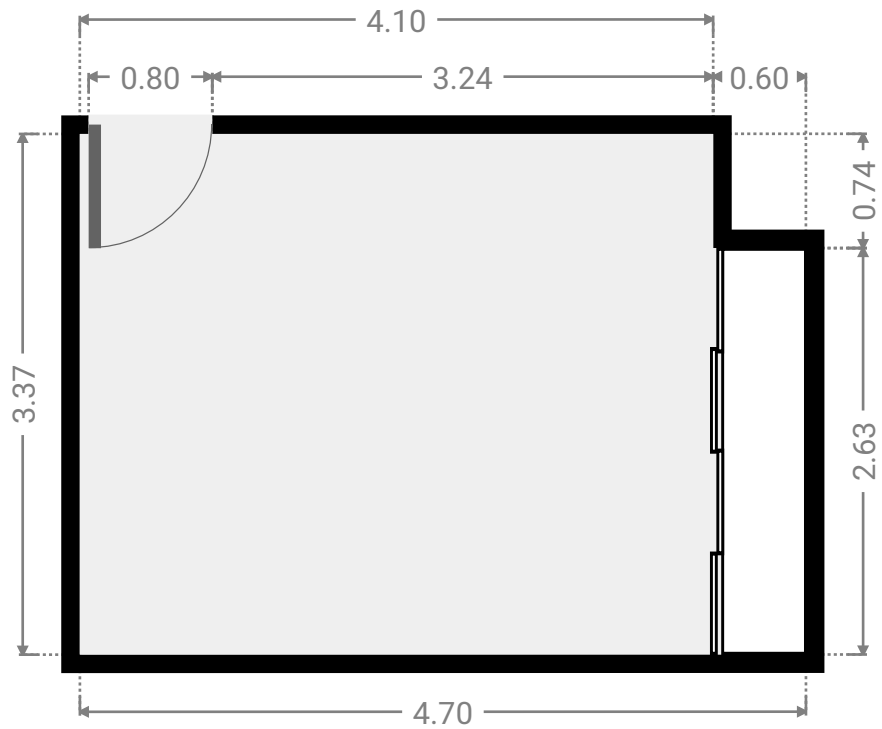

▼ **Closet**  
Ground Floor

WIDTH: 1.50 m • LENGTH: 1.19 m  
AREA: 1.78 m<sup>2</sup> • PERIMETER: 5.38 m

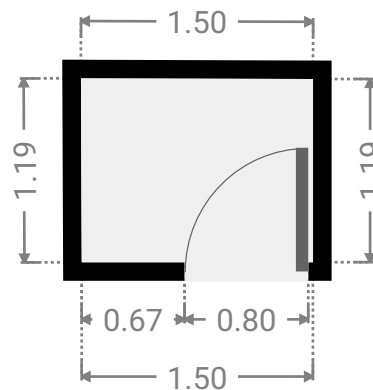



FLOORS: 1

## ▼ Bedroom Ground Floor

WIDTH: 3.60 m • LENGTH: 3.37 m  
AREA: 12.13 m<sup>2</sup> • PERIMETER: 13.94 m

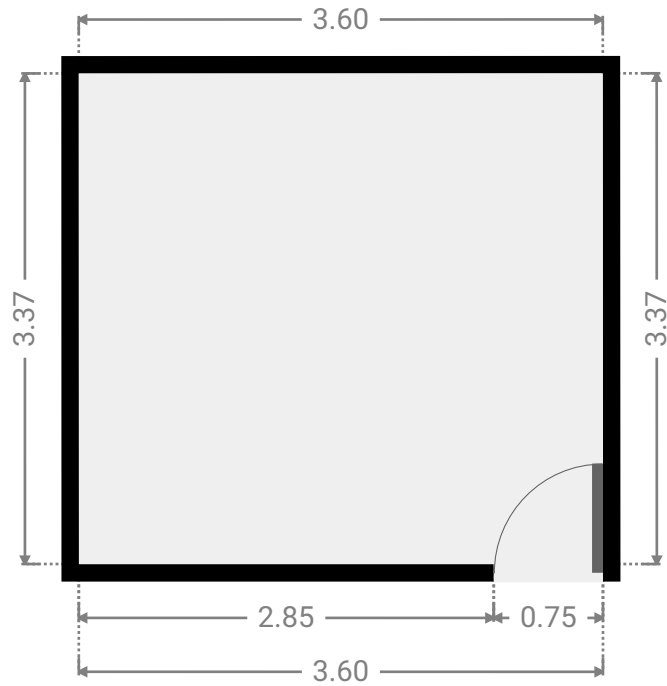

## ▼ Hall Ground Floor

WIDTH: 4.89 m • LENGTH: 1.79 m  
AREA: 7.16 m<sup>2</sup> • PERIMETER: 13.35 m

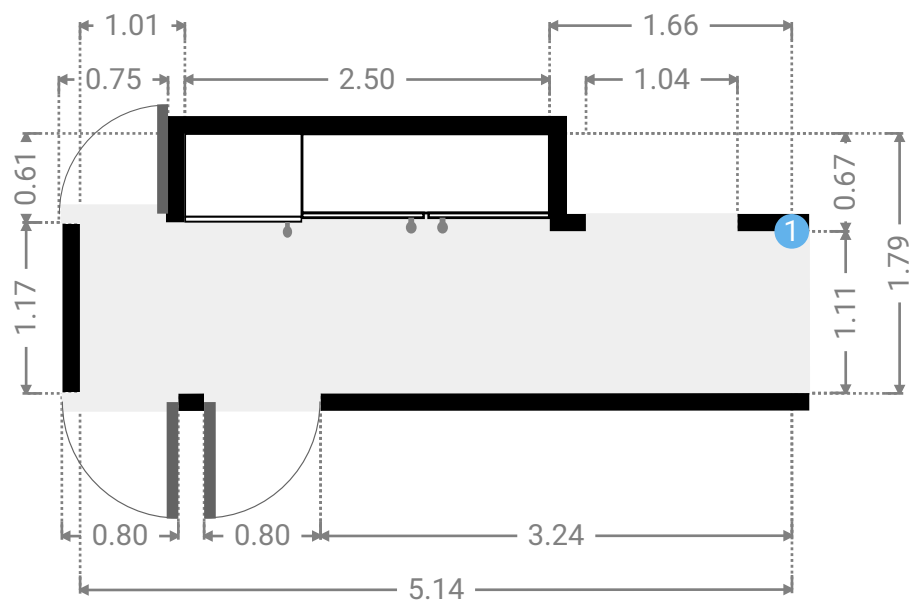

## ▼ Hall/Ground Floor

### 1 OPENING

Height  
0.00 m



## ▼ Closet Ground Floor

WIDTH: 1.20 m • LENGTH: 1.20 m  
AREA: 1.44 m<sup>2</sup> • PERIMETER: 4.80 m

