

17 Haven Close

Ground Floor

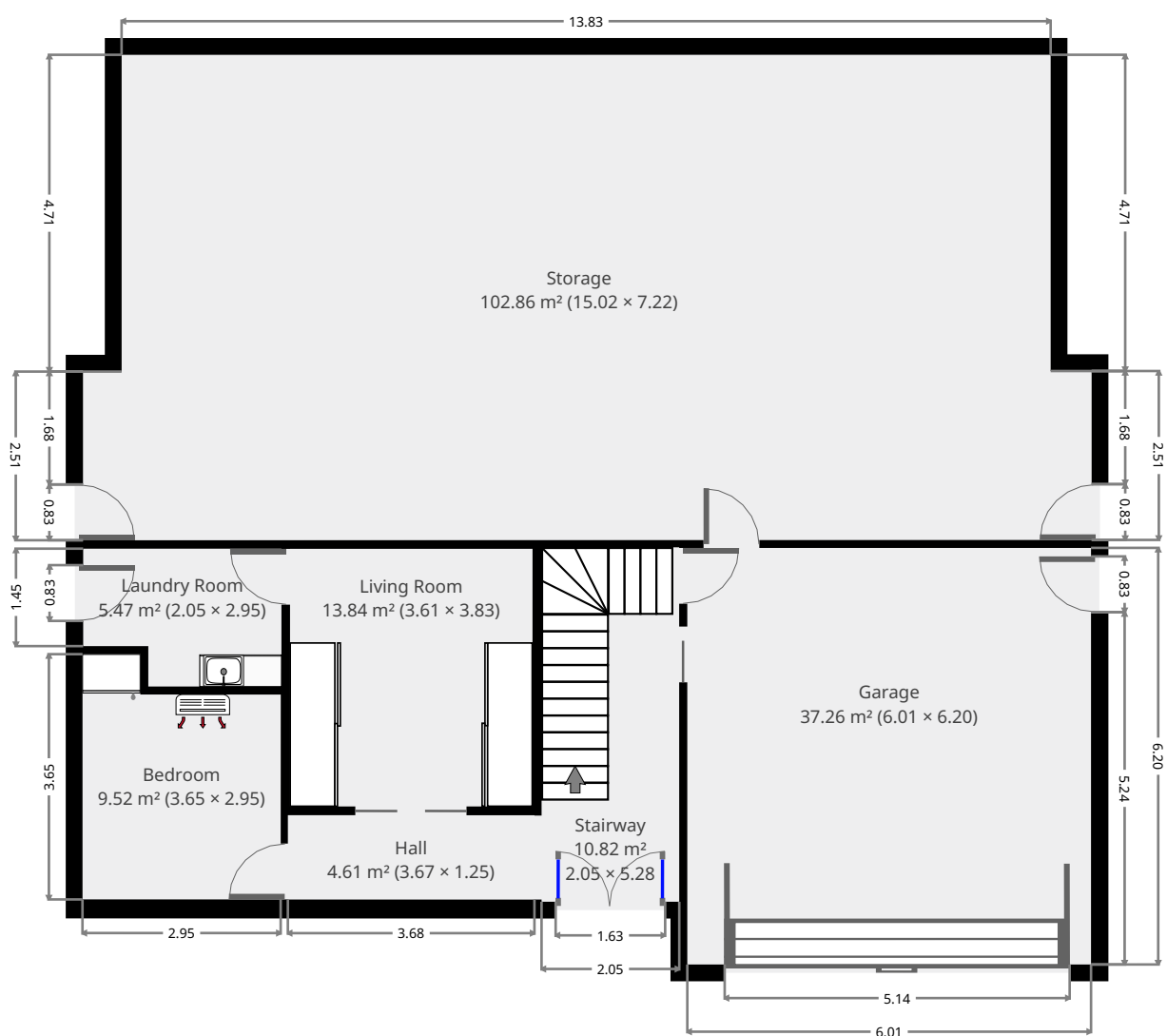

THIS FLOORPLAN IS PROVIDED WITHOUT WARRANTY OF ANY KIND. SENSOPIA DISCLAIMS ANY WARRANTY INCLUDING, WITHOUT LIMITATION, SATISFACTORY QUALITY OR ACCURACY OF DIMENSIONS.

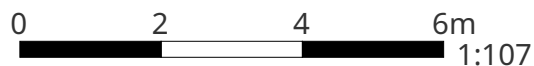

17 Haven Close

Stairway

Width:	2.05 m
Length:	5.28 m
Area	10.82 m ²
Perimeter	14.65 m

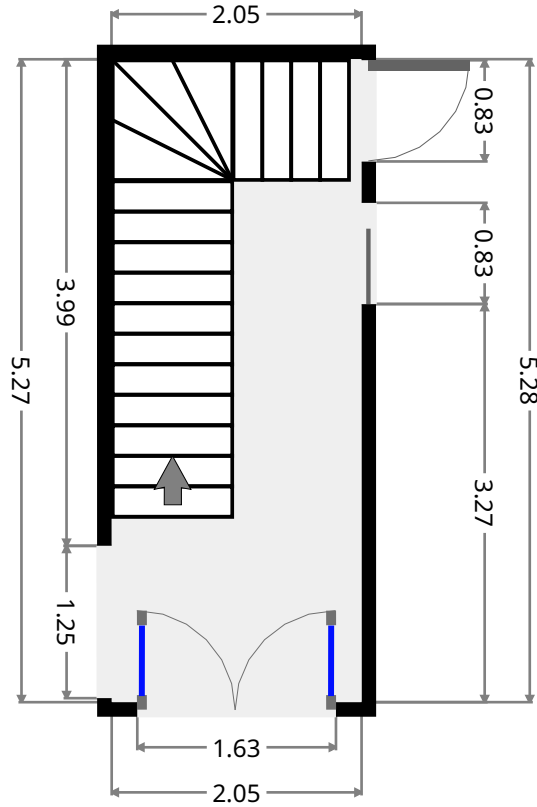
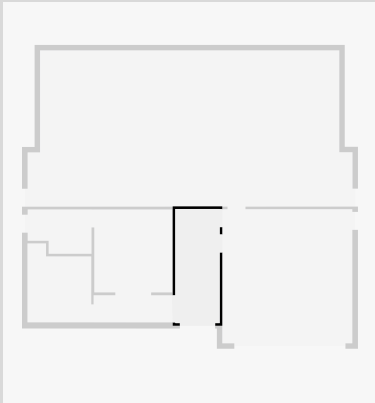

Hall

Width:	1.25 m
Length:	3.67 m
Area	4.61 m ²
Perimeter	9.85 m

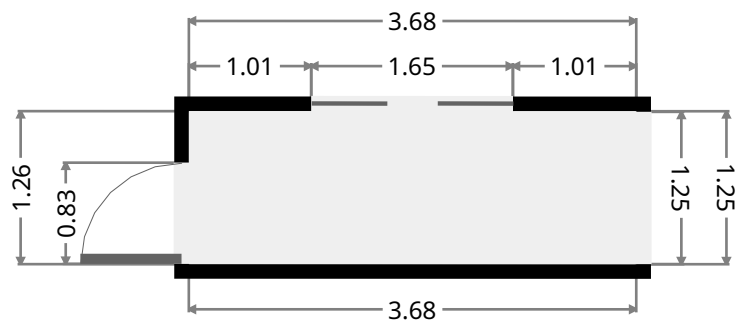
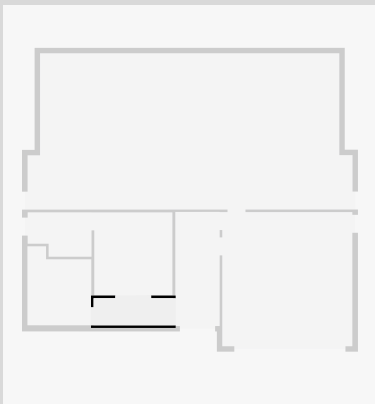

17 Haven Close

Bedroom

Width: 2.95 m
 Length: 3.65 m
 Area: 9.52 m²
 Perimeter: 13.20 m

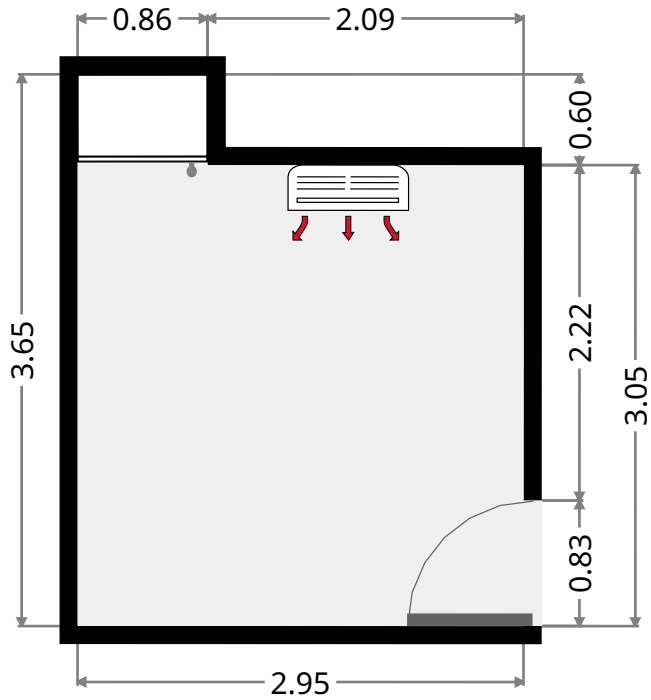
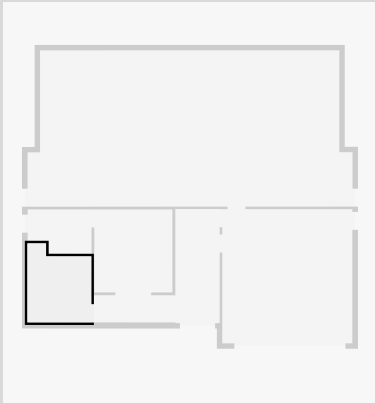

Living Room

Width: 3.61 m
 Length: 3.83 m
 Area: 13.84 m²
 Perimeter: 14.89 m

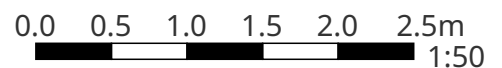
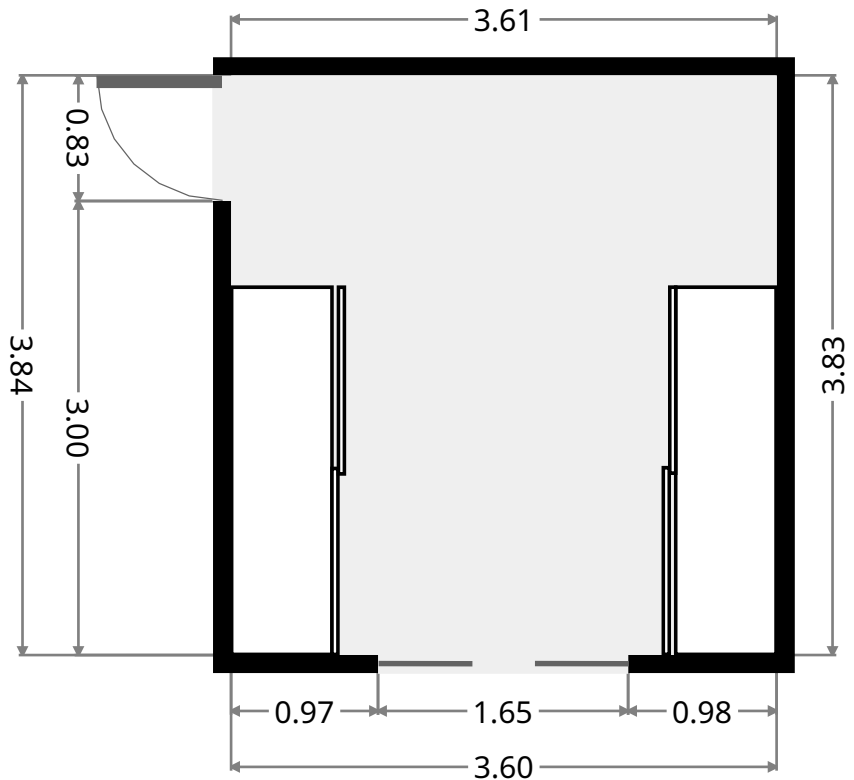
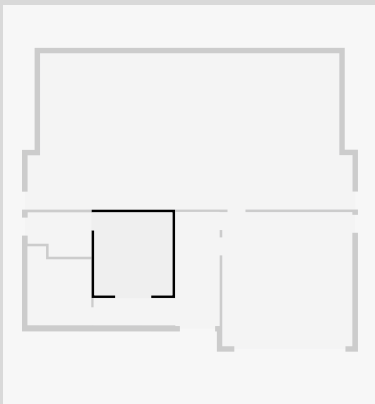

THIS FLOORPLAN IS PROVIDED WITHOUT WARRANTY OF ANY KIND. SENSOPIA DISCLAIMS ANY WARRANTY INCLUDING, WITHOUT LIMITATION, SATISFACTORY QUALITY OR ACCURACY OF DIMENSIONS.

17 Haven Close

Laundry Room

Width: 2.05 m
 Length: 2.95 m
 Area: 5.47 m²
 Perimeter: 10.00 m

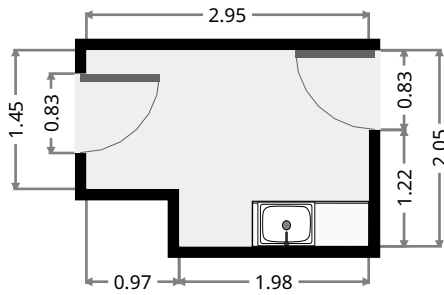
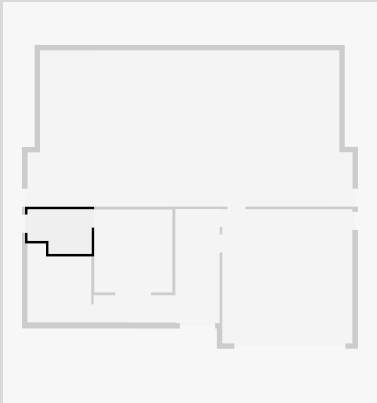

Garage

Width: 6.01 m
 Length: 6.20 m
 Area: 37.26 m²
 Perimeter: 24.42 m

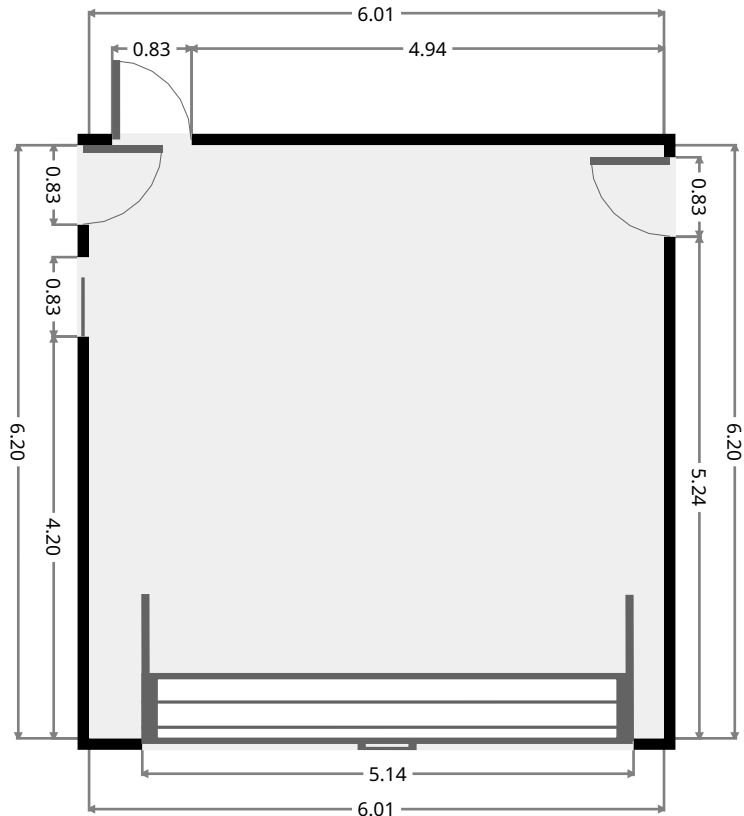
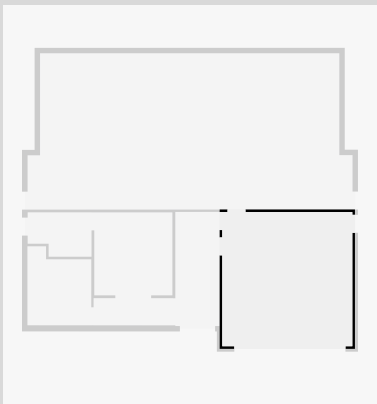

THIS FLOORPLAN IS PROVIDED WITHOUT WARRANTY OF ANY KIND. SENSOPIA DISCLAIMS ANY WARRANTY INCLUDING, WITHOUT LIMITATION, SATISFACTORY QUALITY OR ACCURACY OF DIMENSIONS.

17 Haven Close

Storage

Width: 7.22 m
Length: 15.02 m
Area: 102.86 m²
Perimeter: 44.48 m

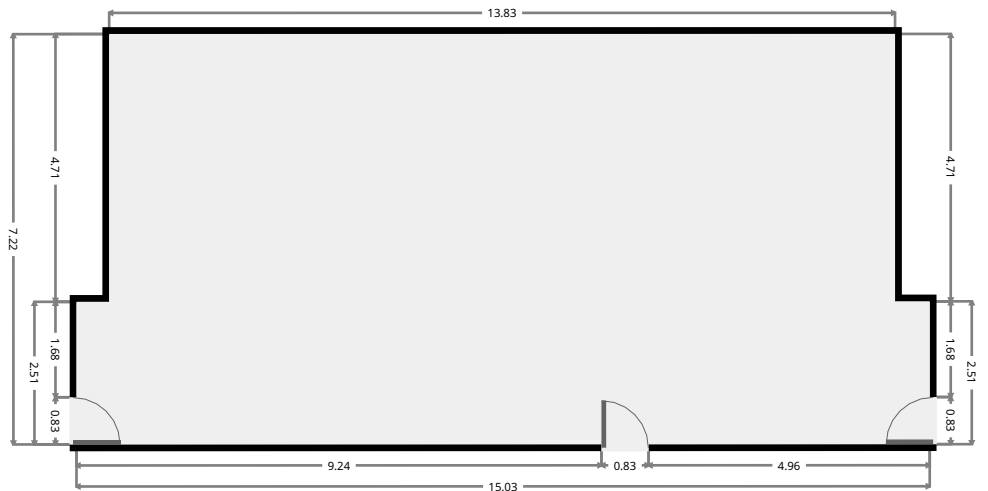
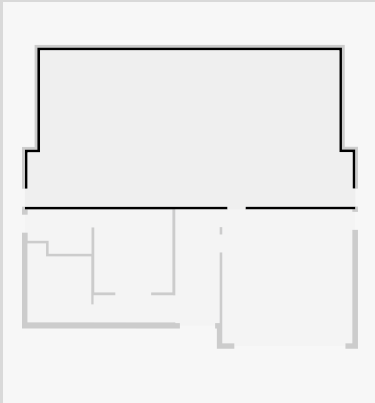

17 Haven Close

1st Floor

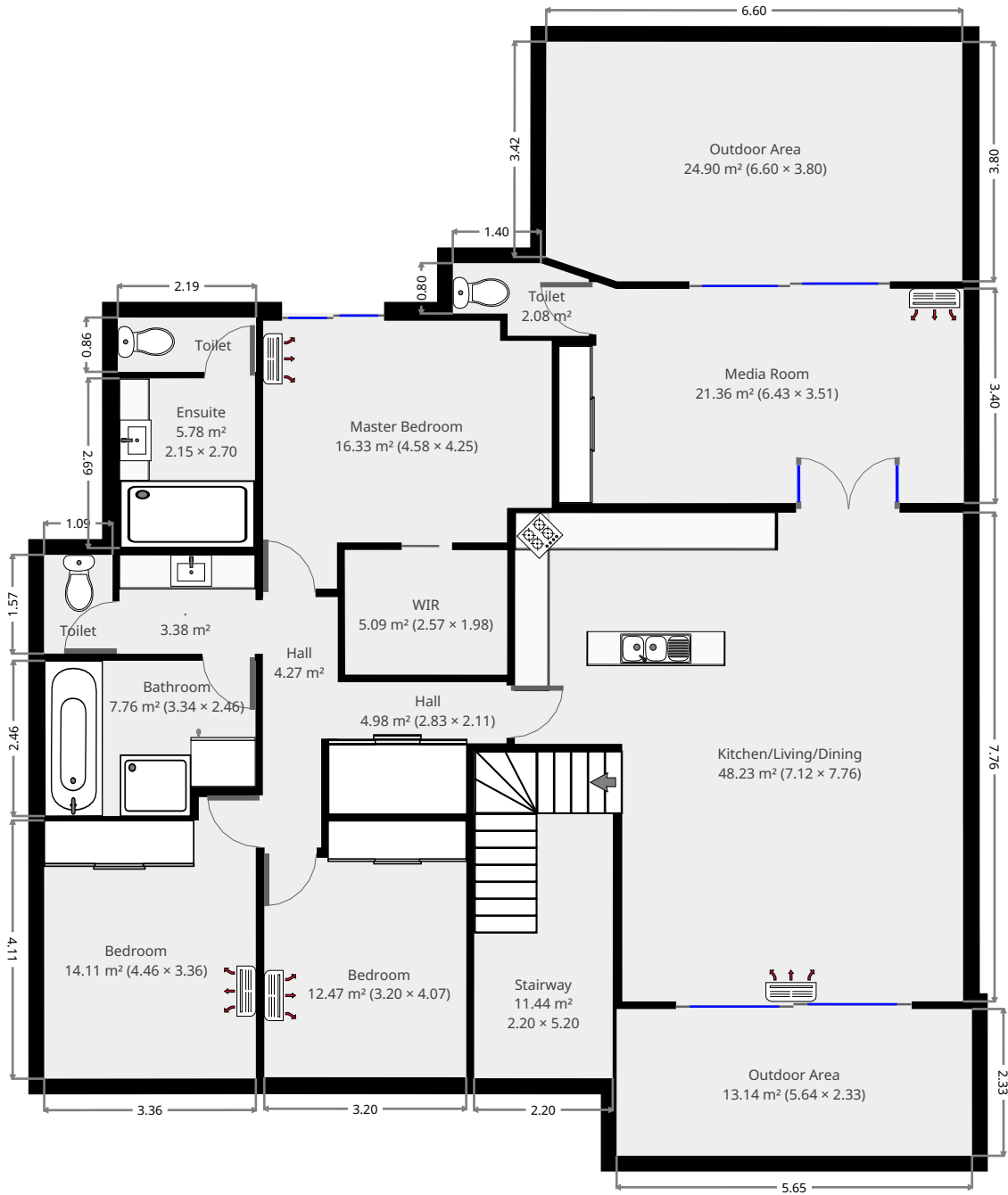

THIS FLOORPLAN IS PROVIDED WITHOUT WARRANTY OF ANY KIND. SENSOPIA DISCLAIMS ANY WARRANTY INCLUDING, WITHOUT LIMITATION, SATISFACTORY QUALITY OR ACCURACY OF DIMENSIONS.



17 Haven Close

Bathroom

Width: 2.46 m
Length: 3.34 m
Area: 7.76 m²
Perimeter: 11.61 m

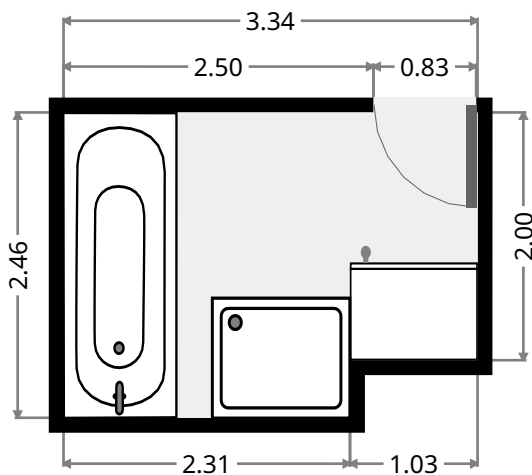
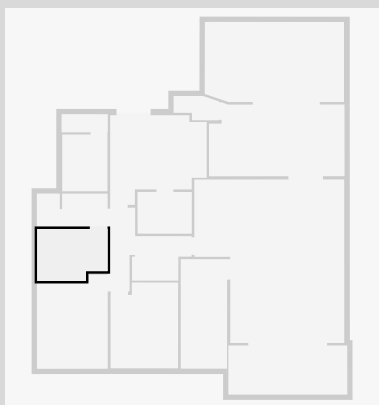

Outdoor Area

Width: 3.80 m
Length: 6.60 m
Area: 24.90 m²
Perimeter: 20.50 m

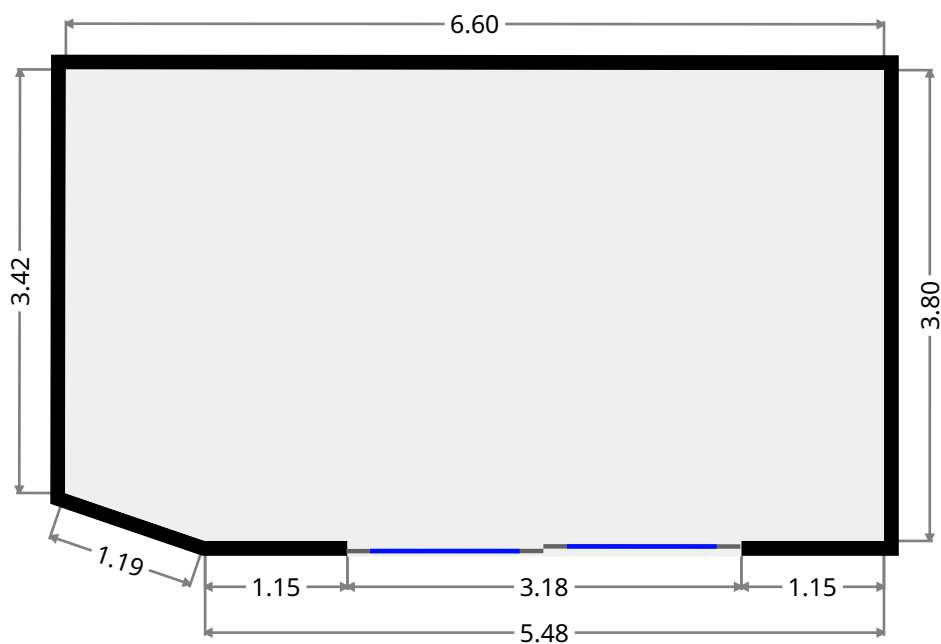
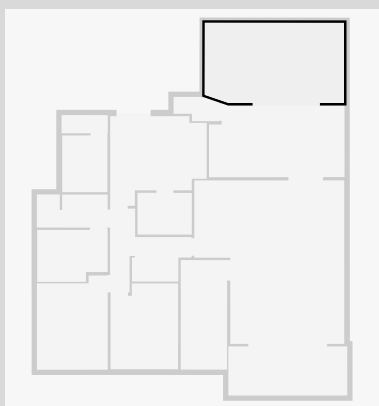

17 Haven Close

Outdoor Area

Width: 2.33 m
 Length: 5.64 m
 Area: 13.14 m²
 Perimeter: 15.94 m

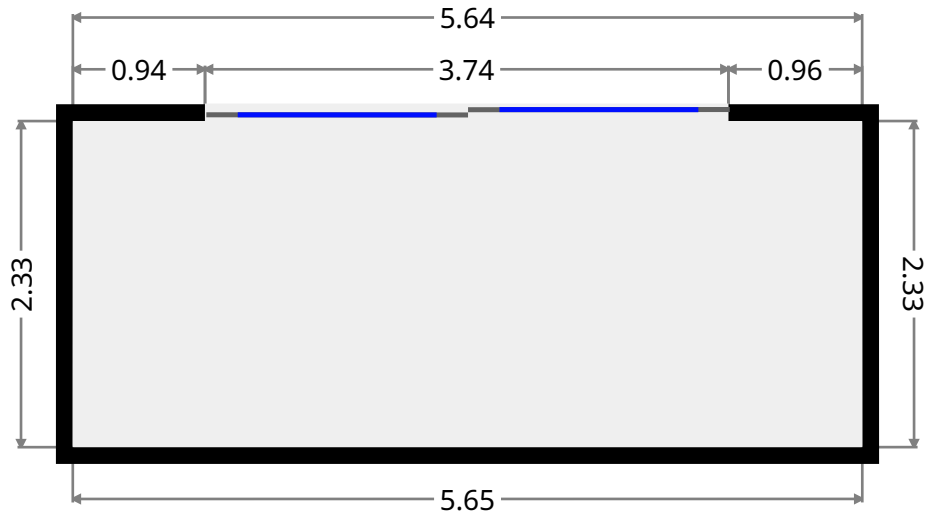
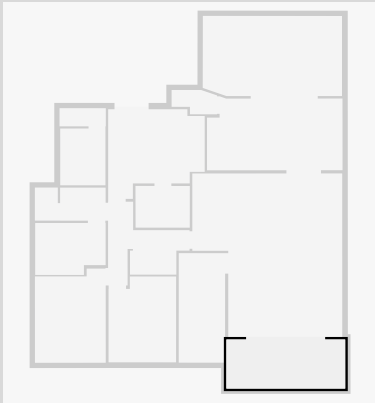

Toilet

Width: 0.87 m
 Length: 2.19 m
 Area: 1.89 m²
 Perimeter: 6.11 m

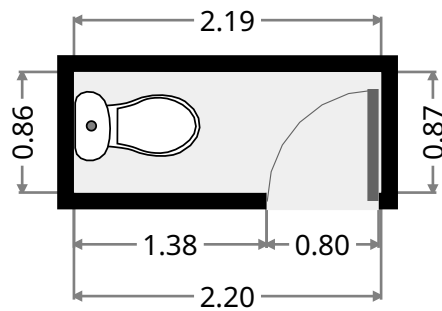
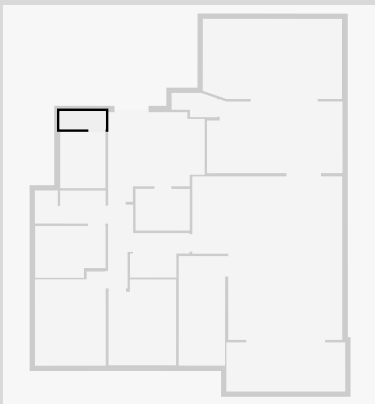

17 Haven Close

Ensuite

Width: 2.15 m
Length: 2.70 m
Area: 5.78 m²
Perimeter: 9.68 m

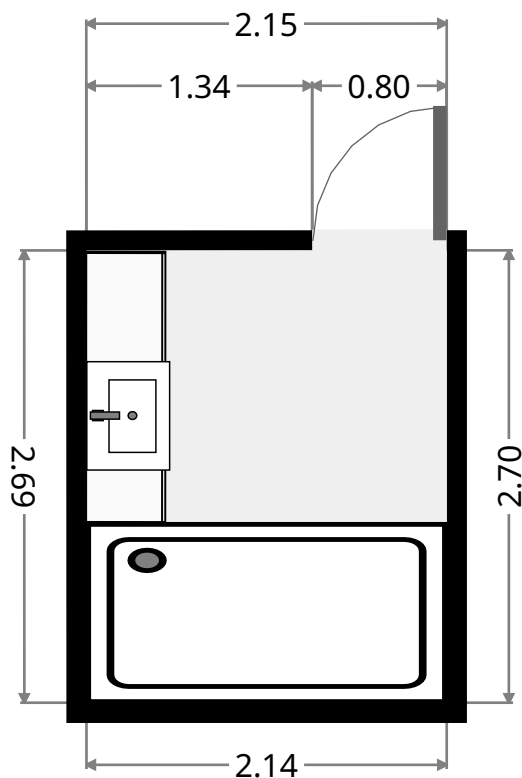
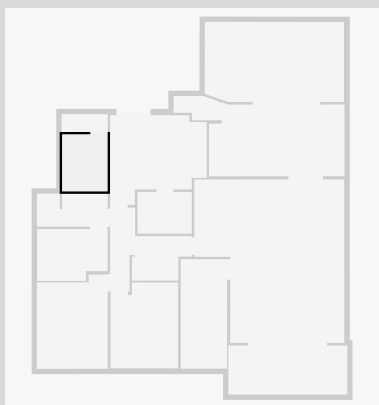

WIR

Width: 1.98 m
Length: 2.57 m
Area: 5.09 m²
Perimeter: 9.11 m

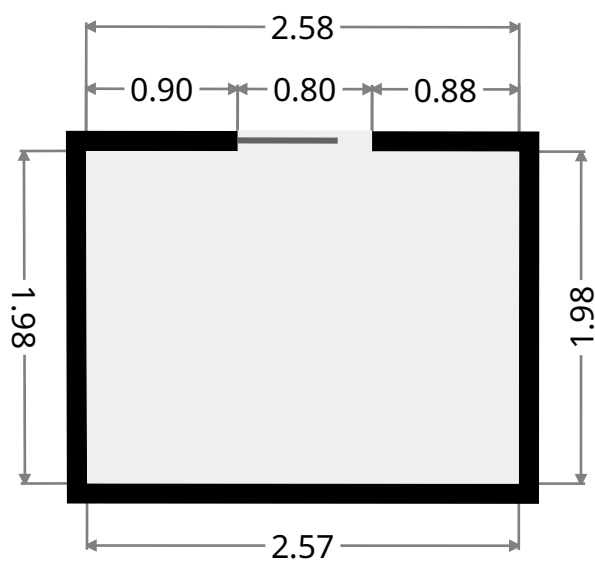
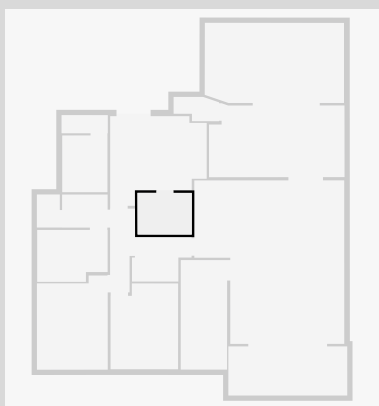

17 Haven Close

Master Bedroom

Width: 4.25 m
 Length: 4.58 m
 Area: 16.33 m²
 Perimeter: 17.67 m

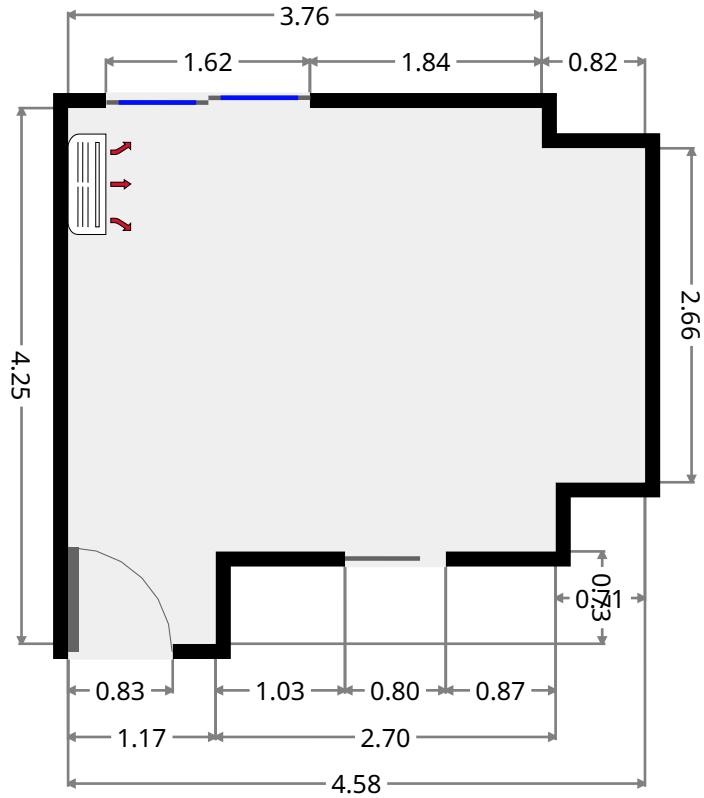
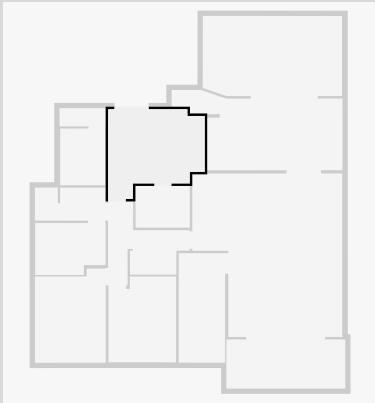

Toilet

Width: 1.09 m
 Length: 1.57 m
 Area: 1.71 m²
 Perimeter: 5.31 m

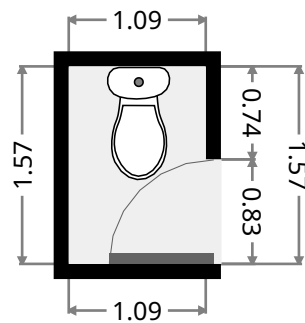
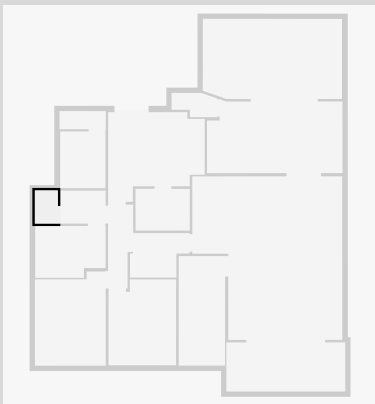

17 Haven Close

•
 Width: 1.57 m
 Length: 2.16 m
 Area: 3.38 m²
 Perimeter: 7.45 m

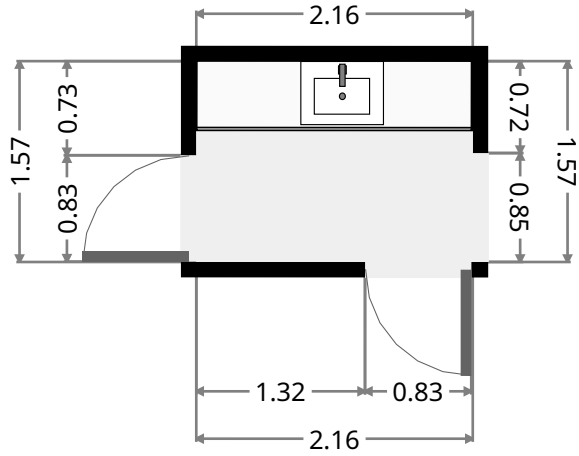
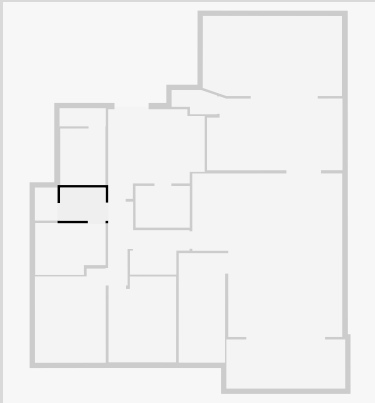

Stairway

Width: 2.20 m
 Length: 5.20 m
 Area: 11.44 m²
 Perimeter: 14.80 m

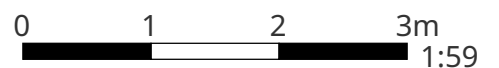
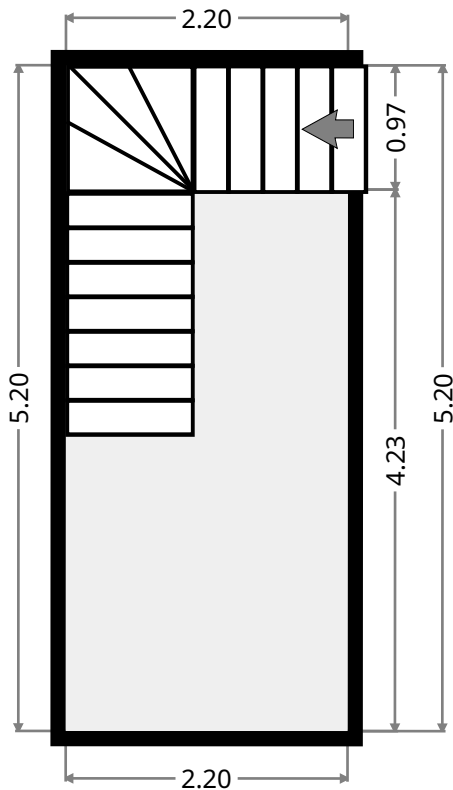
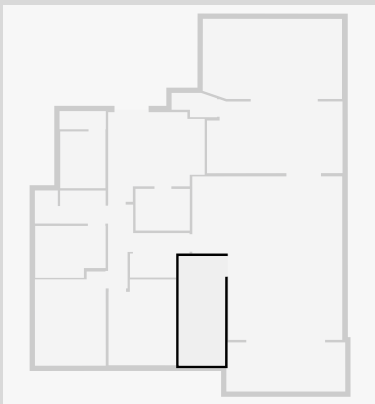

17 Haven Close

Bedroom

Width: 3.36 m
 Length: 4.46 m
 Area: 14.11 m²
 Perimeter: 15.66 m

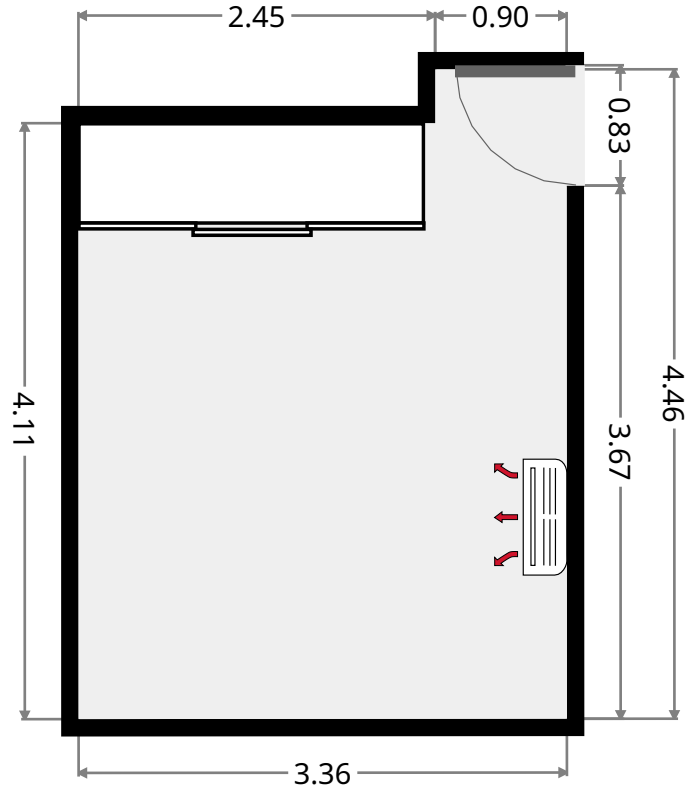
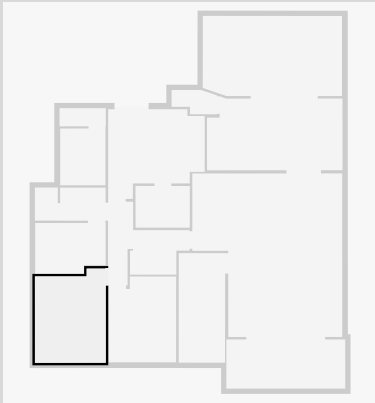

Bedroom

Width: 3.20 m
 Length: 4.07 m
 Area: 12.47 m²
 Perimeter: 14.56 m

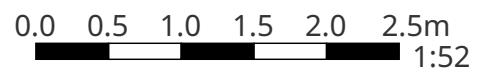
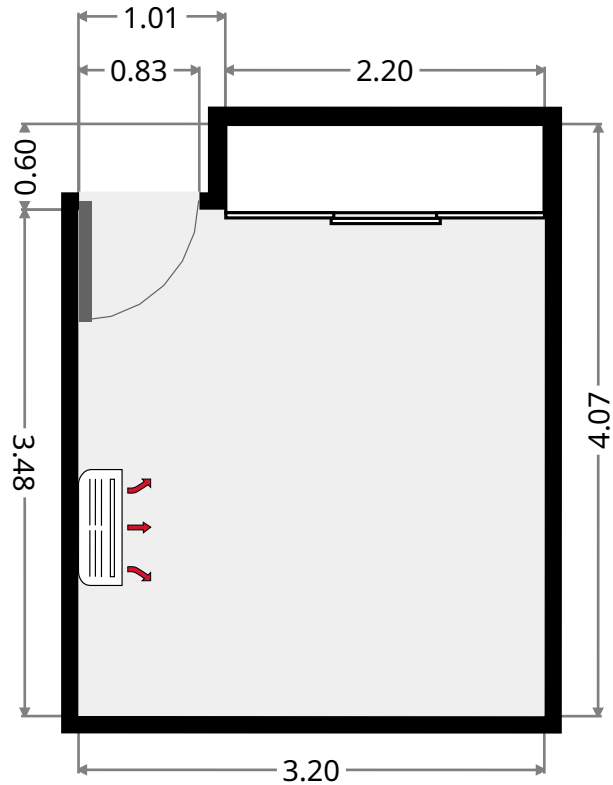
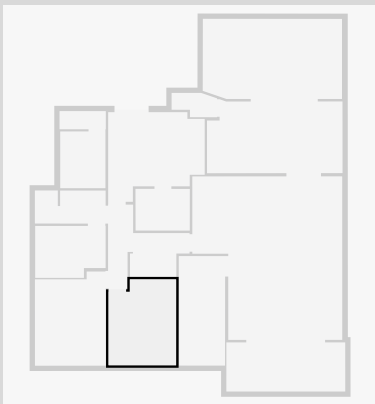

17 Haven Close

Hall

Width: 1.19 m
 Length: 3.97 m
 Area: 4.27 m²
 Perimeter: 10.33 m

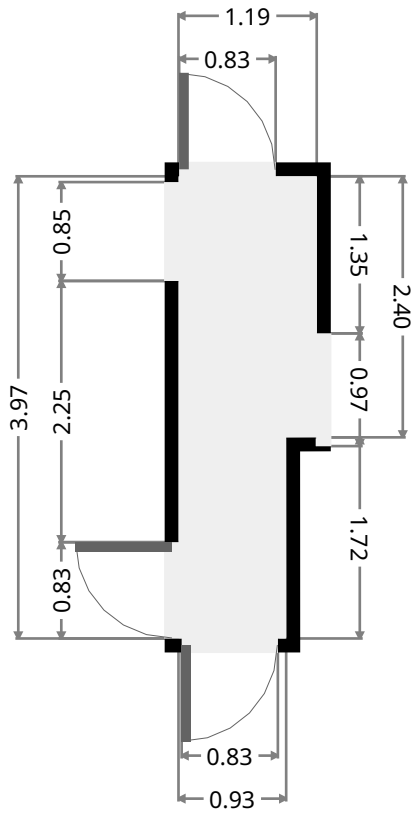
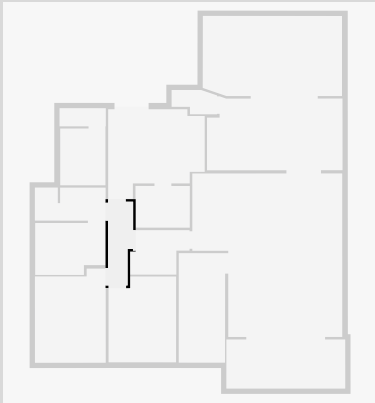

Hall

Width: 2.11 m
 Length: 2.83 m
 Area: 4.98 m²
 Perimeter: 9.87 m

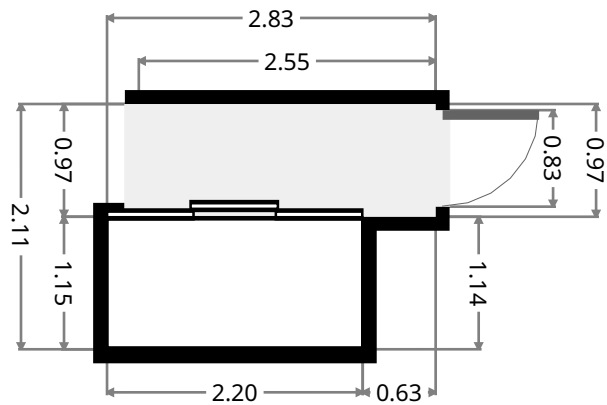
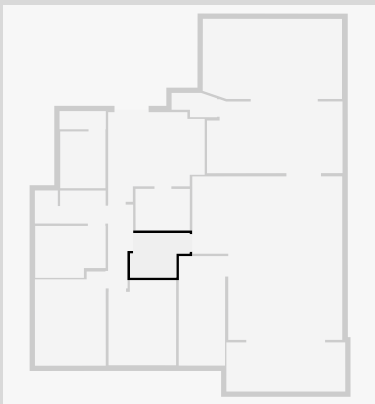

17 Haven Close

Toilet

Width: 1.15 m
 Length: 2.16 m
 Area: 2.08 m²
 Perimeter: 6.41 m

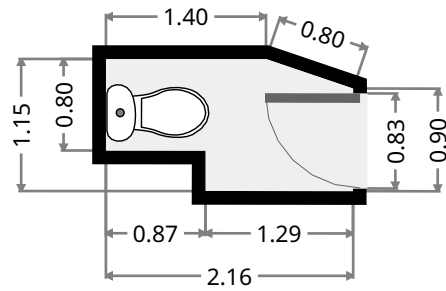
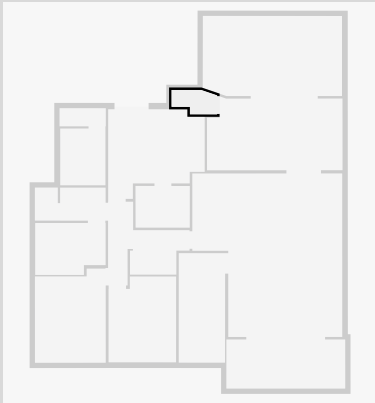

Media Room

Width: 3.51 m
 Length: 6.43 m
 Area: 21.36 m²
 Perimeter: 19.79 m

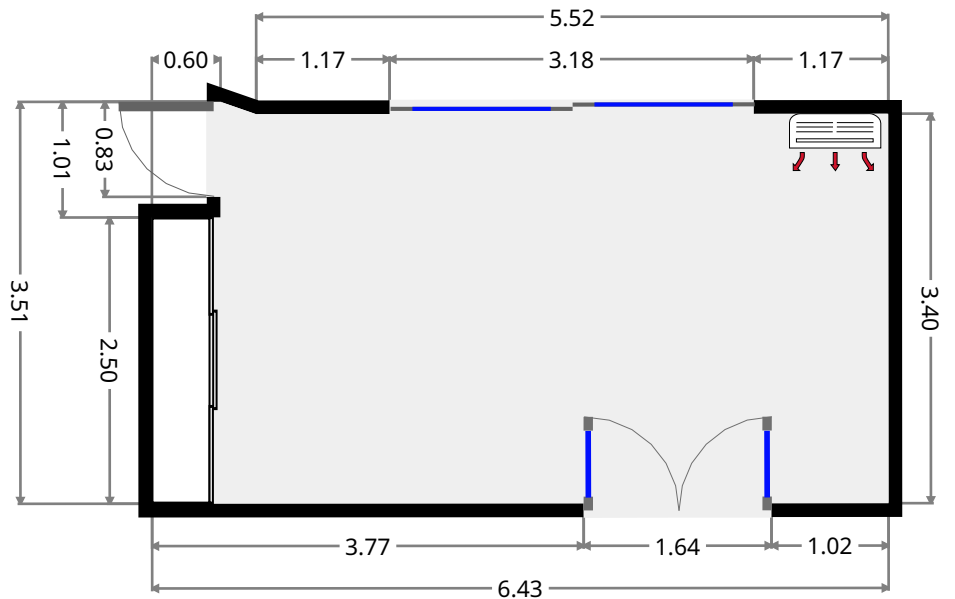
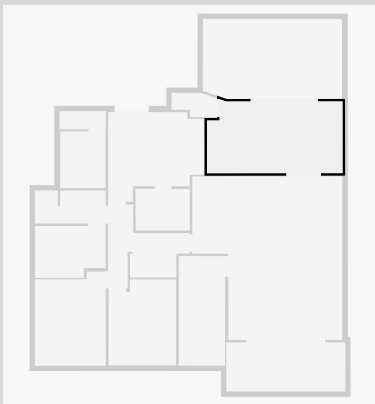

17 Haven Close

Kitchen/Living/Dining

Width: 7.12 m
 Length: 7.76 m
 Area: 48.23 m²
 Perimeter: 29.75 m

