

# 17 Edenbrook Drive

**SUBMITTED BY**

Ray White Rockhampton Casey  
stockers@cqoz.com

---

**CREATED ON**

2022-07-05

---

**Floors**

1

---

▼ Ground Floor



FLOORS: 1

▼ **Bathroom**  
Ground Floor

WIDTH: 3.67 m • LENGTH: 2.10 m  
AREA: 6.55 m<sup>2</sup> • PERIMETER: 11.54 m

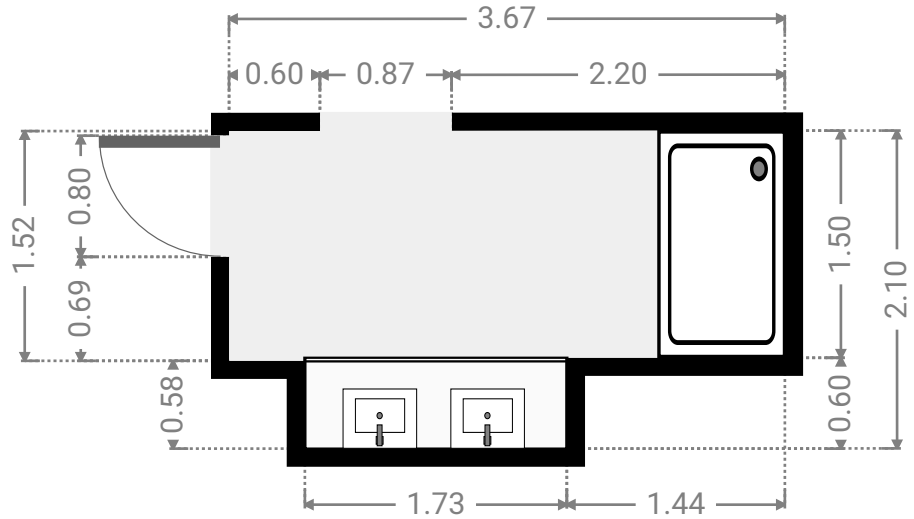
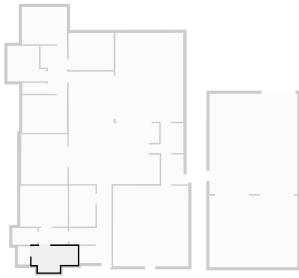

▼ **Bathroom**  
Ground Floor

WIDTH: 3.10 m • LENGTH: 2.83 m  
AREA: 7.67 m<sup>2</sup> • PERIMETER: 11.85 m

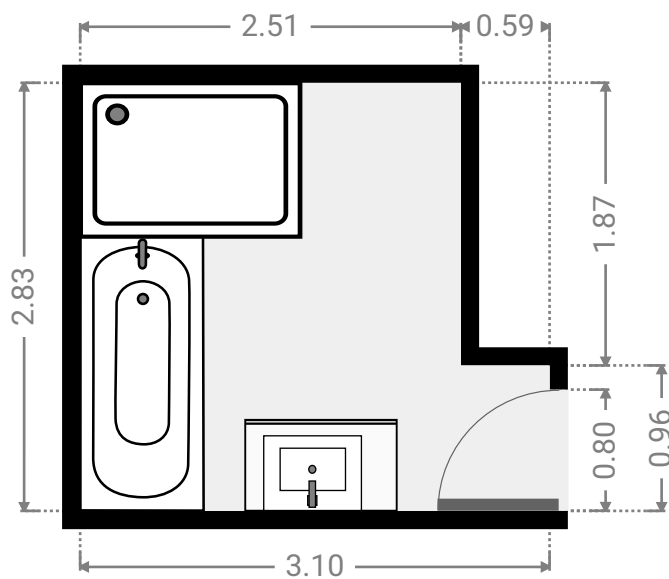
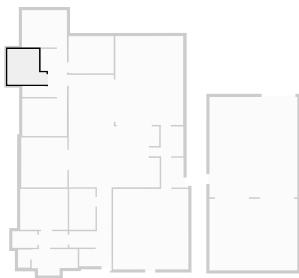

FLOORS: 1

▼ **Bedroom**  
Ground Floor

WIDTH: 3.56 m • LENGTH: 3.00 m  
AREA: 10.68 m<sup>2</sup> • PERIMETER: 13.12 m

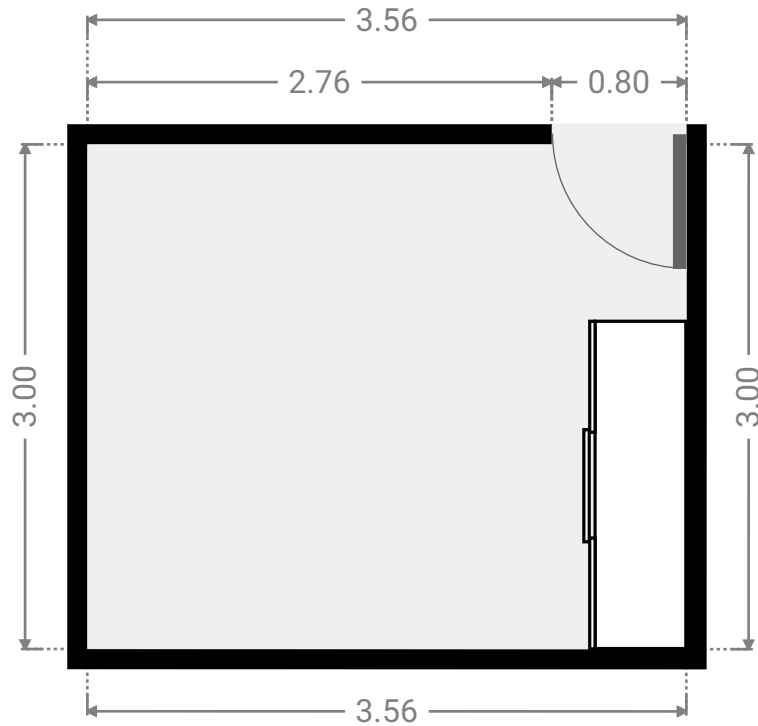
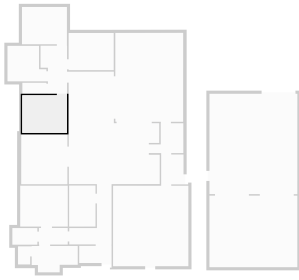

▼ **Bedroom**  
Ground Floor

WIDTH: 3.58 m • LENGTH: 2.97 m  
AREA: 10.63 m<sup>2</sup> • PERIMETER: 13.10 m

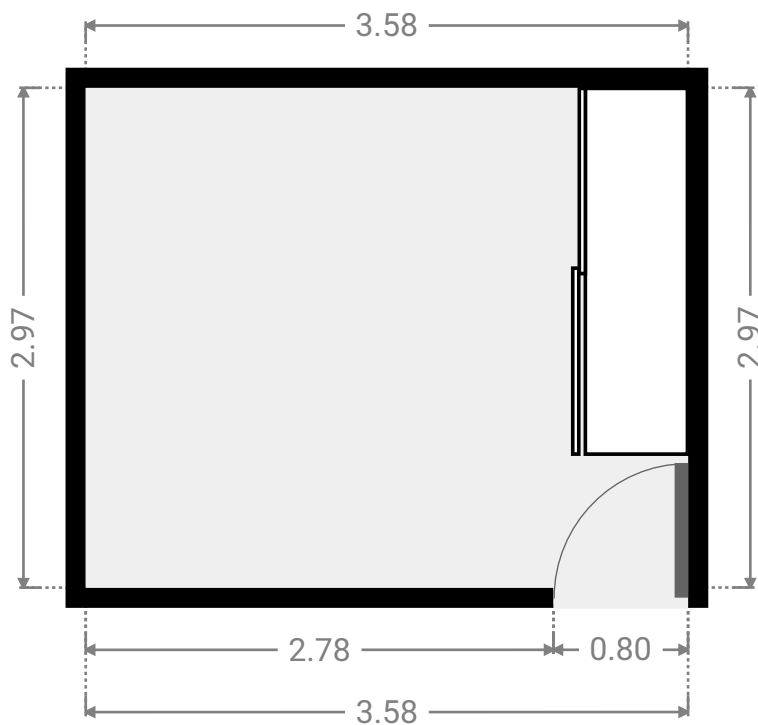

FLOORS: 1

▼ **Bedroom**  
Ground Floor

WIDTH: 3.59 m • LENGTH: 2.96 m  
AREA: 10.63 m<sup>2</sup> • PERIMETER: 13.10 m

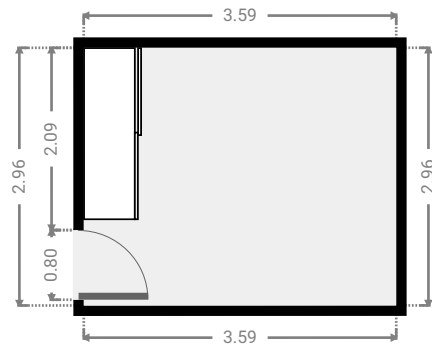
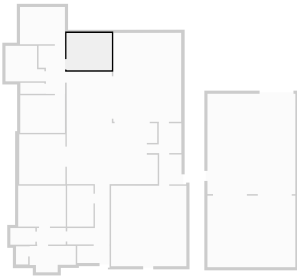

▼ **Garage**  
Ground Floor

WIDTH: 7.00 m • LENGTH: 5.70 m  
AREA: 39.90 m<sup>2</sup> • PERIMETER: 25.40 m

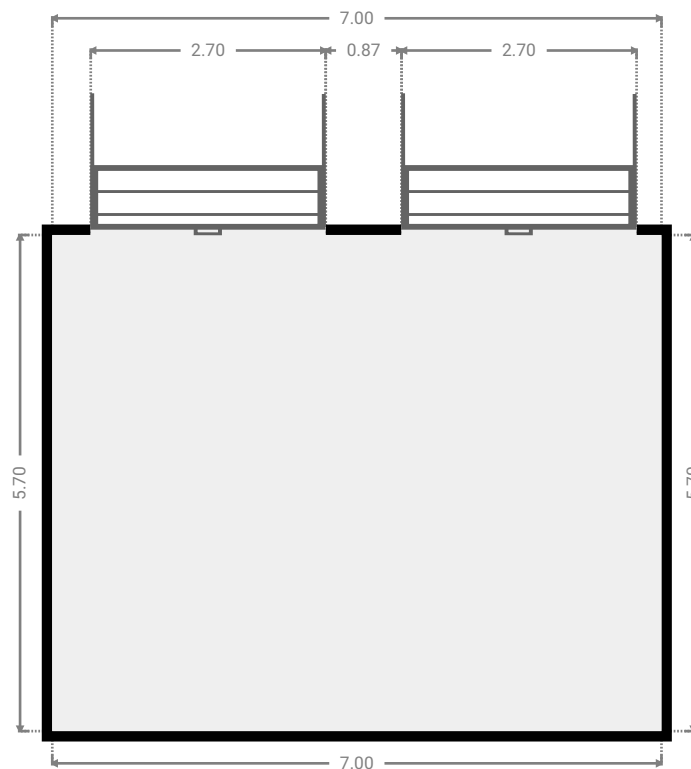
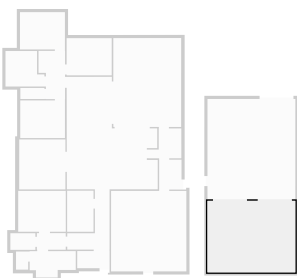

FLOORS: 1

▼ **Garage**  
Ground Floor

WIDTH: 7.00 m • LENGTH: 8.00 m  
AREA: 55.98 m<sup>2</sup> • PERIMETER: 29.99 m

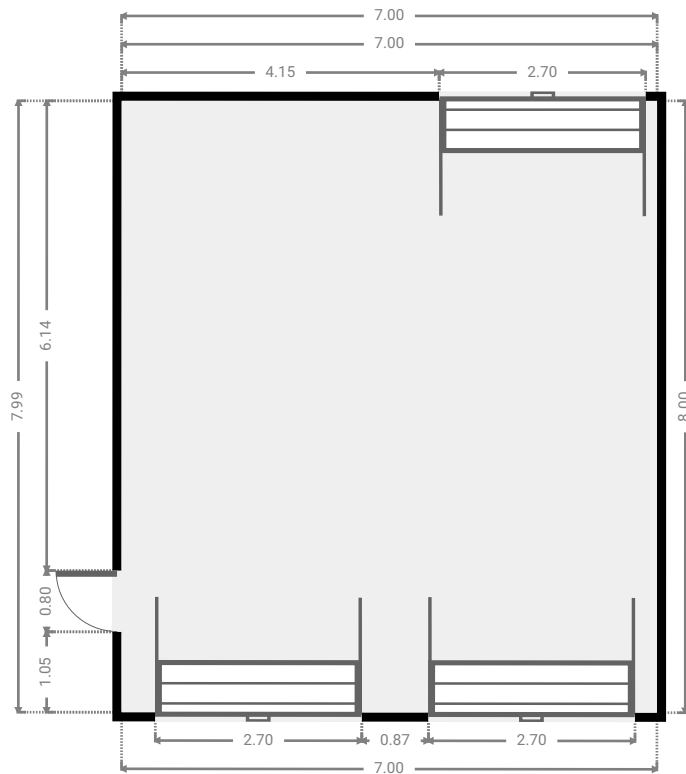
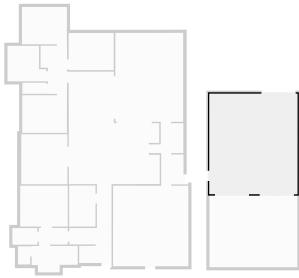

▼ **Hall**  
Ground Floor

WIDTH: 3.37 m • LENGTH: 4.68 m  
AREA: 8.34 m<sup>2</sup> • PERIMETER: 16.11 m

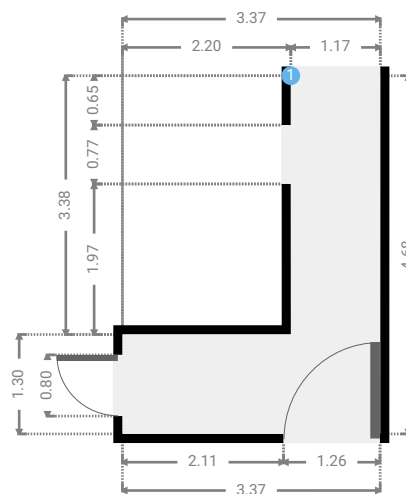
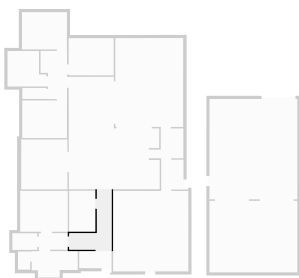

## ▼ Hall/Ground Floor

---

### 1 OPENING

Height  
0.00 m



FLOORS: 1

▼ **Hall**  
Ground Floor

WIDTH: 2.30 m • LENGTH: 1.32 m  
AREA: 3.04 m<sup>2</sup> • PERIMETER: 7.24 m

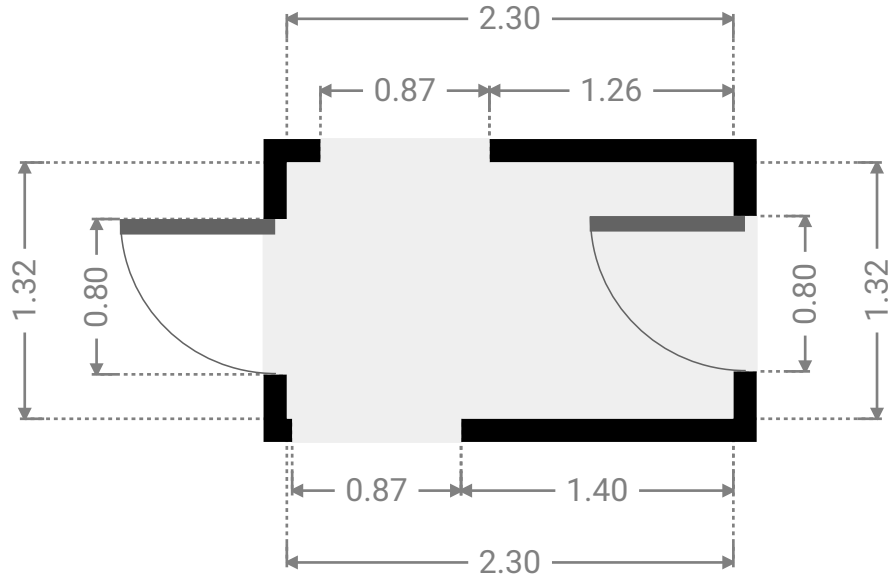

▼ **Closet**  
Ground Floor

WIDTH: 1.99 m • LENGTH: 1.32 m  
AREA: 2.63 m<sup>2</sup> • PERIMETER: 6.63 m

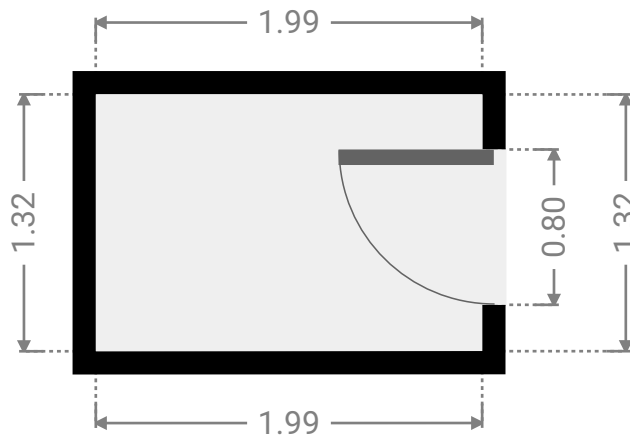
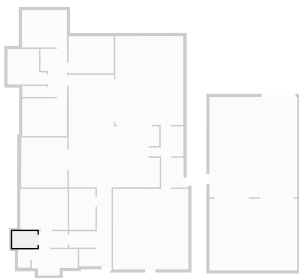



FLOORS: 1

▼ **Hall**  
Ground Floor

WIDTH: 2.11 m • LENGTH: 3.84 m  
AREA: 6.88 m<sup>2</sup> • PERIMETER: 11.90 m

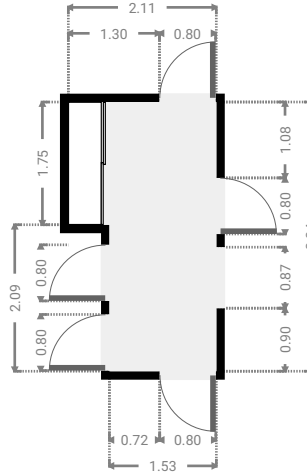

▼ **Kitchen**  
Ground Floor

WIDTH: 7.26 m • LENGTH: 8.97 m  
AREA: 49.05 m<sup>2</sup> • PERIMETER: 34.07 m

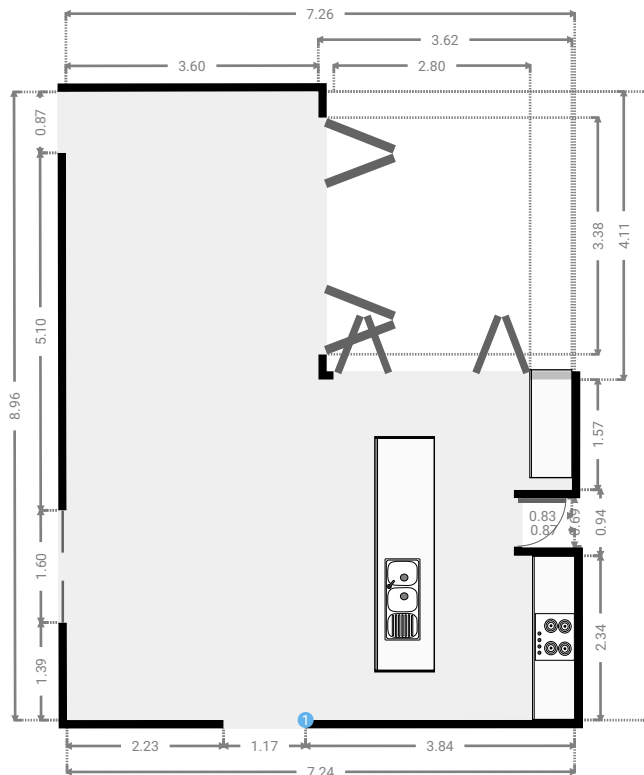
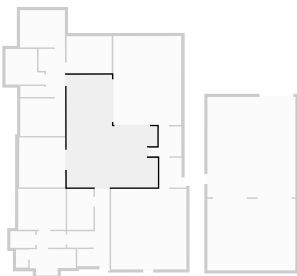

FLOORS: 1

▼ **Laundry Room**  
Ground Floor

WIDTH: 2.63 m • LENGTH: 2.38 m  
AREA: 4.85 m<sup>2</sup> • PERIMETER: 10.01 m

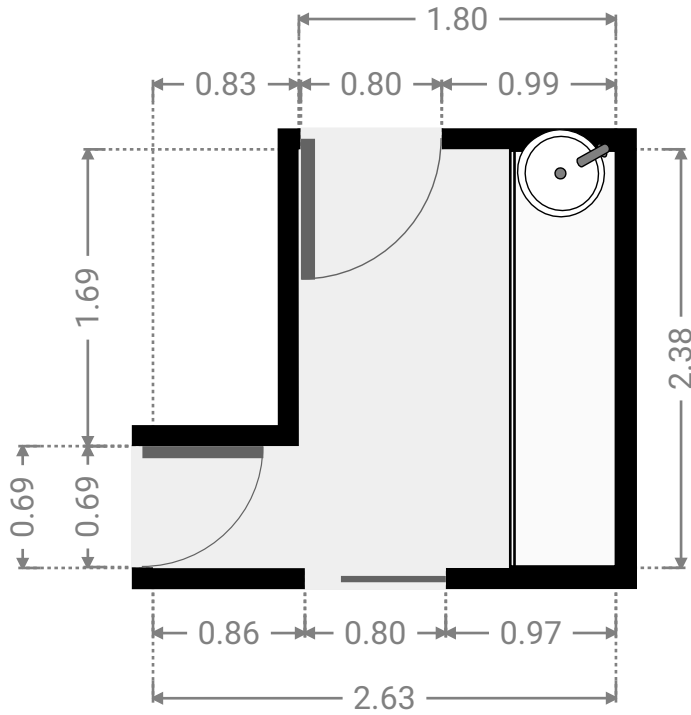

▼ **Laundry Room**  
Ground Floor

WIDTH: 1.78 m • LENGTH: 2.38 m  
AREA: 4.24 m<sup>2</sup> • PERIMETER: 8.32 m

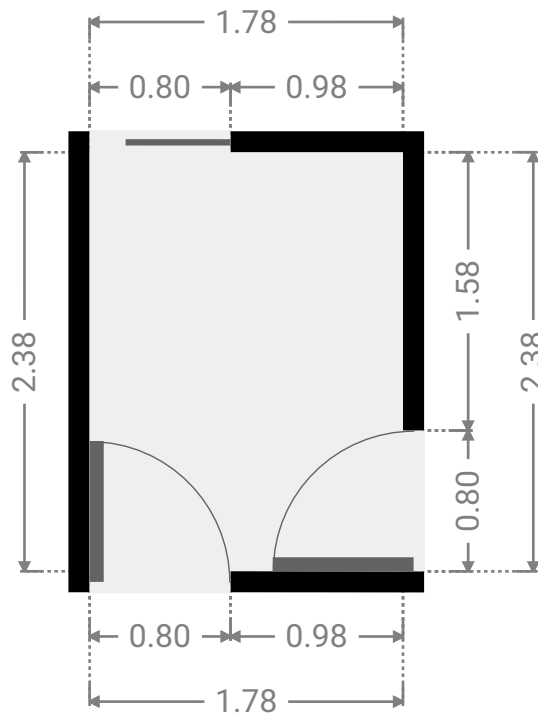

FLOORS: 1

▼ **Living Room**  
Ground Floor

WIDTH: 5.41 m • LENGTH: 7.09 m  
AREA: 38.25 m<sup>2</sup> • PERIMETER: 24.97 m

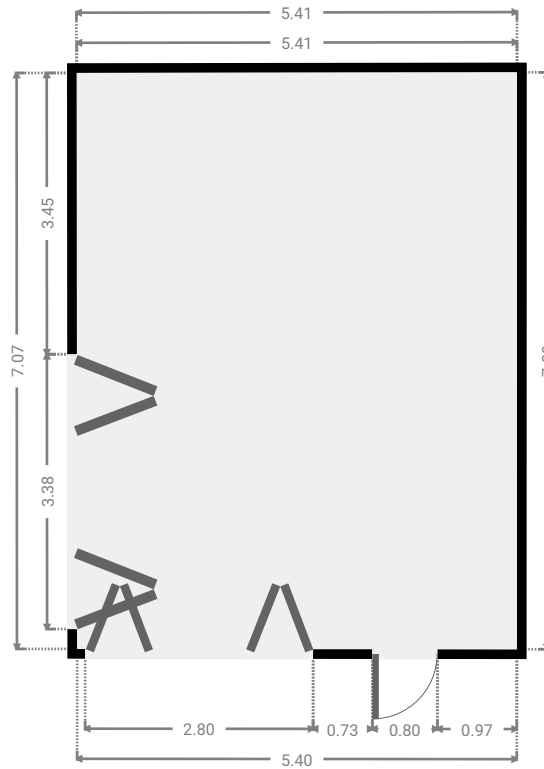
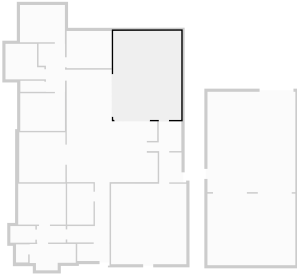

▼ **Living Room**  
Ground Floor

WIDTH: 6.00 m • LENGTH: 6.41 m  
AREA: 38.45 m<sup>2</sup> • PERIMETER: 24.82 m

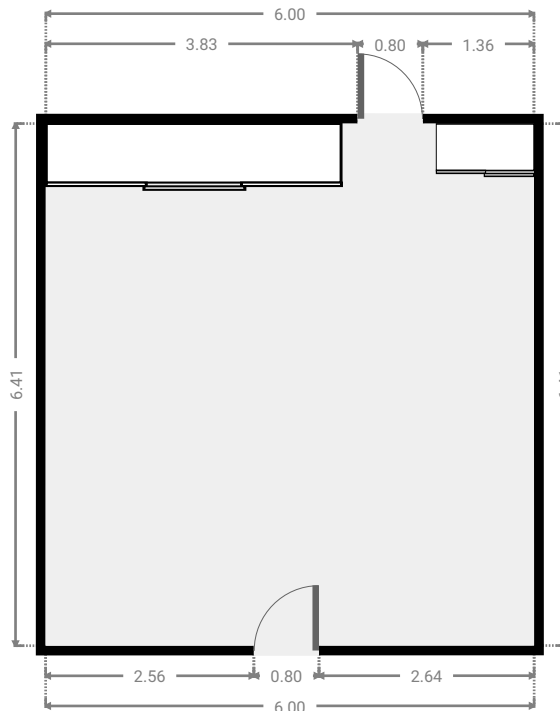
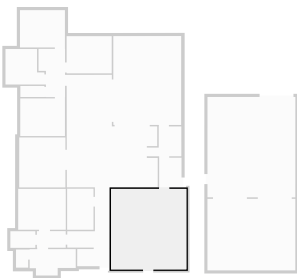

FLOORS: 1

▼ **Living Room**  
Ground Floor

WIDTH: 3.68 m • LENGTH: 3.98 m  
AREA: 14.63 m<sup>2</sup> • PERIMETER: 15.31 m

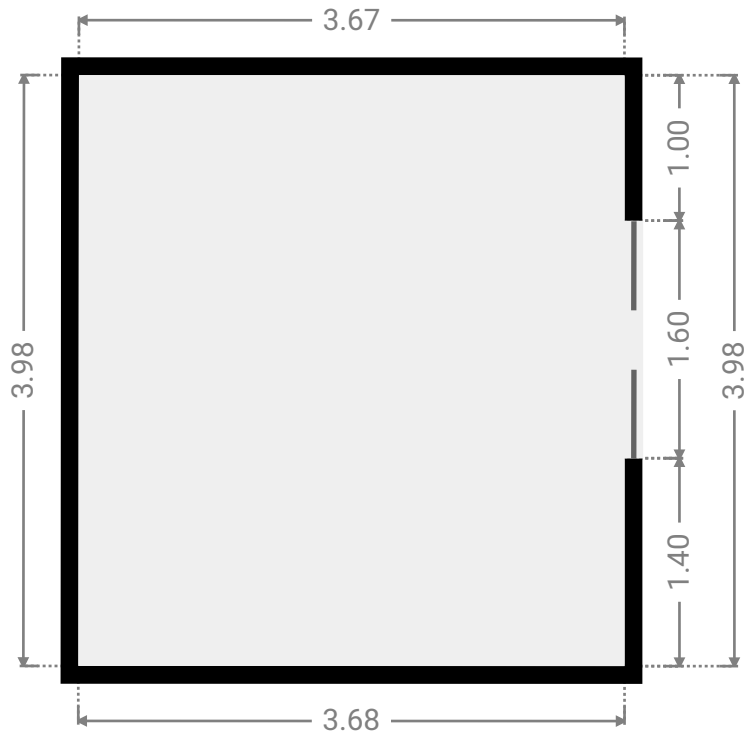

▼ **Other**  
Ground Floor

WIDTH: 2.58 m • LENGTH: 1.37 m  
AREA: 3.52 m<sup>2</sup> • PERIMETER: 7.88 m

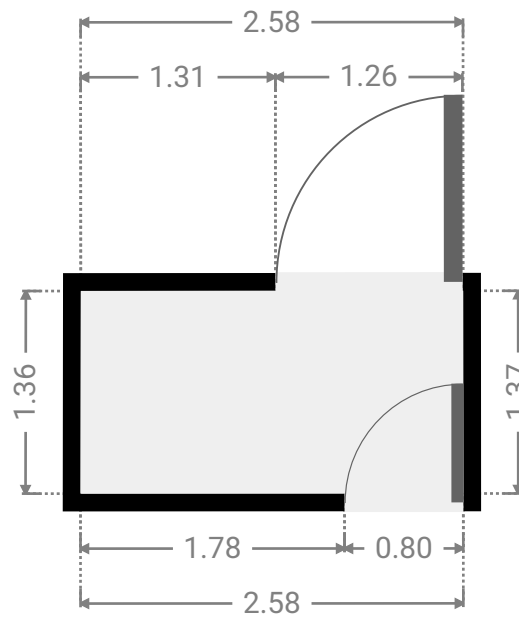

FLOORS: 1

▼ **Primary Bedroom**  
Ground Floor

WIDTH: 3.79 m • LENGTH: 3.26 m  
AREA: 12.34 m<sup>2</sup> • PERIMETER: 14.09 m

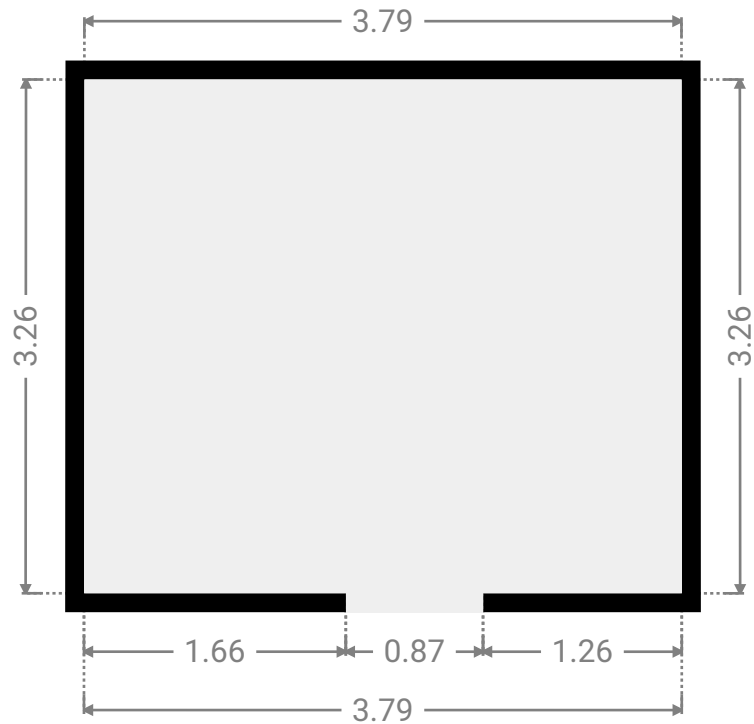

▼ **Study**  
Ground Floor

WIDTH: 2.10 m • LENGTH: 3.27 m  
AREA: 6.87 m<sup>2</sup> • PERIMETER: 10.74 m

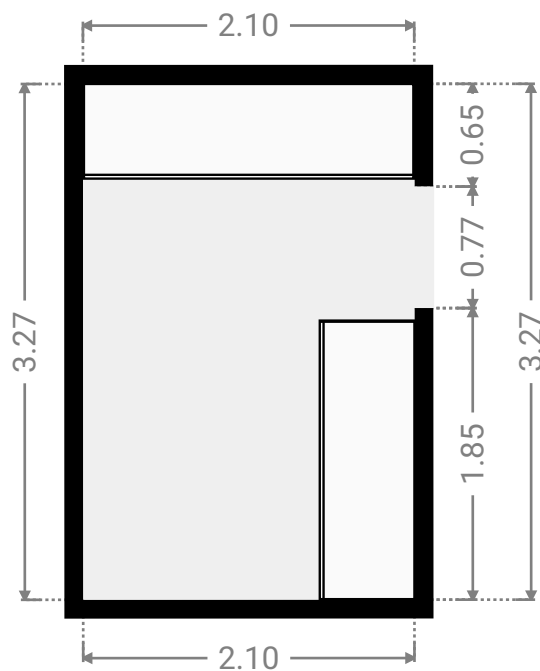
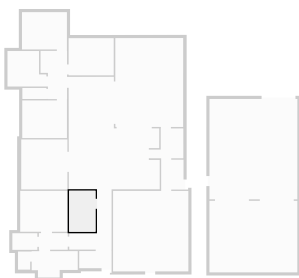

FLOORS: 1

▼ **Toilet**  
Ground Floor

WIDTH: 0.97 m • LENGTH: 1.44 m  
AREA: 1.39 m<sup>2</sup> • PERIMETER: 4.82 m

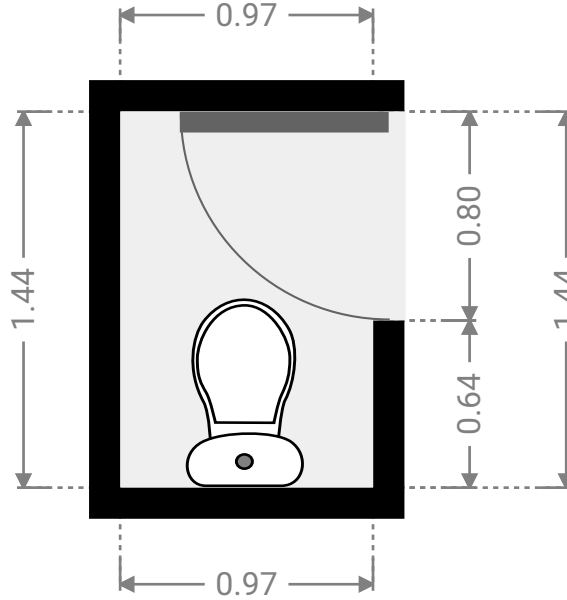

▼ **Vestibule**  
Ground Floor

WIDTH: 1.91 m • LENGTH: 0.88 m  
AREA: 1.68 m<sup>2</sup> • PERIMETER: 5.59 m

