

# 17 Cowap Street

## Ground Floor

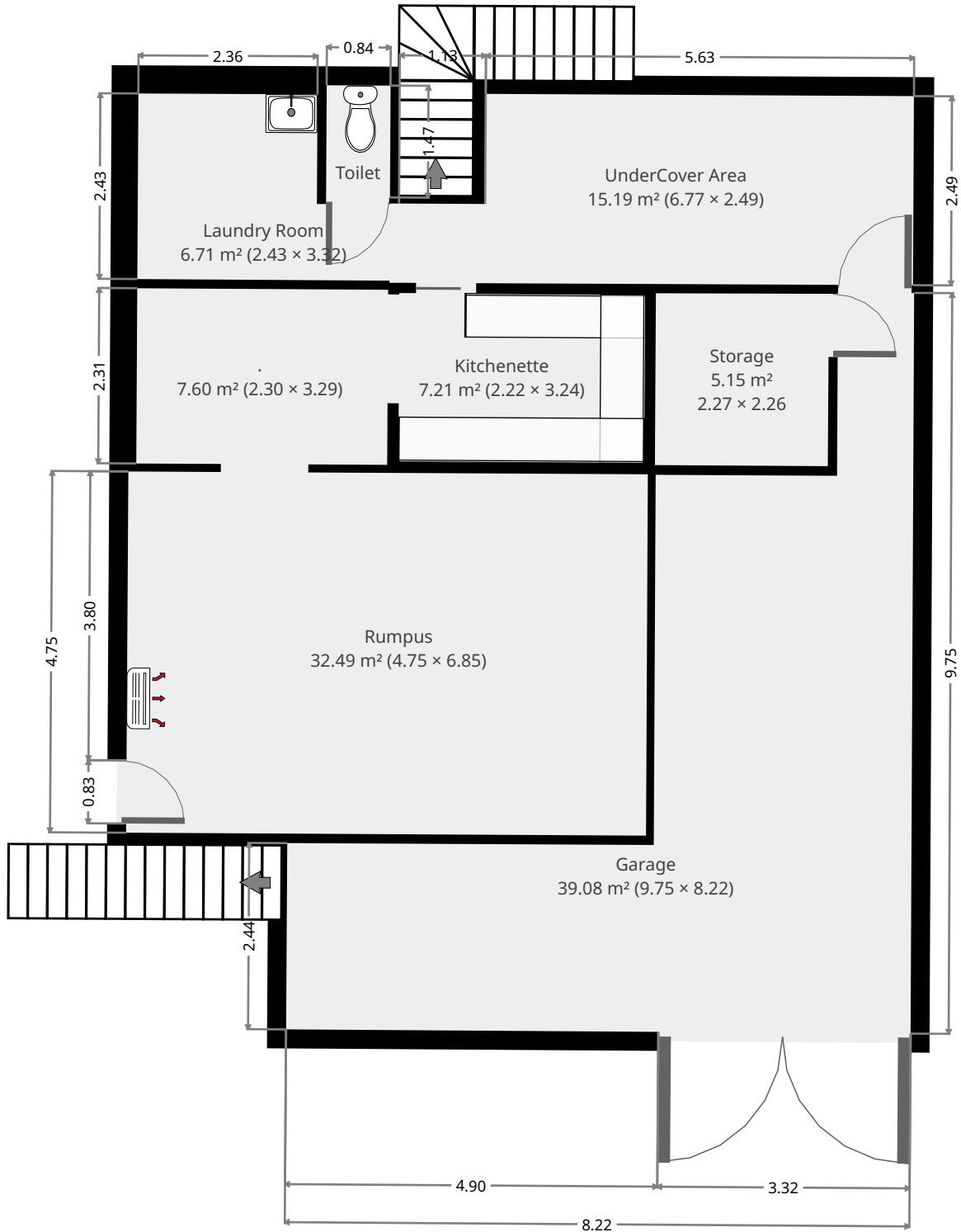

THIS FLOORPLAN IS PROVIDED WITHOUT WARRANTY OF ANY KIND. SENSOPIA DISCLAIMS ANY WARRANTY INCLUDING, WITHOUT LIMITATION, SATISFACTORY QUALITY OR ACCURACY OF DIMENSIONS.



# 17 Cowap Street

## Rumpus

Width: 4.75 m  
 Length: 6.85 m  
 Area: 32.49 m<sup>2</sup>  
 Perimeter: 23.18 m

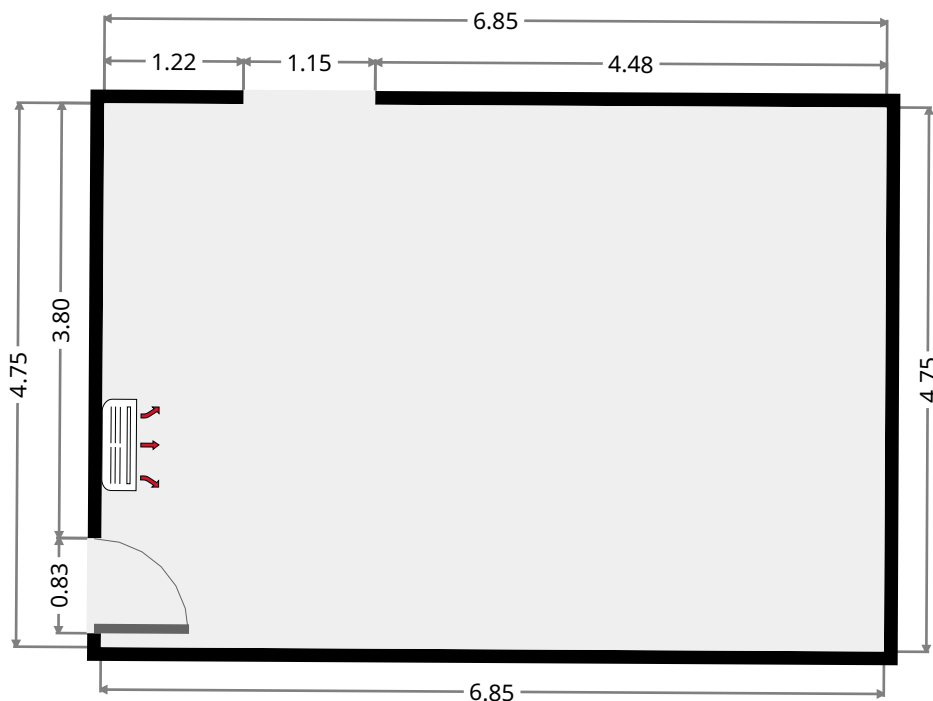
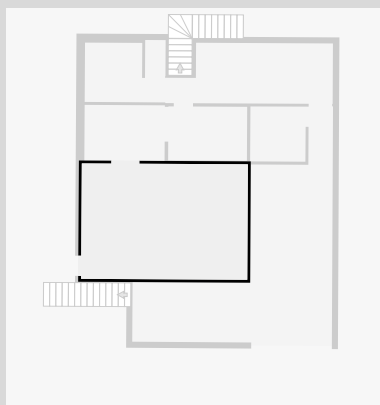

•  
 Width: 2.30 m  
 Length: 3.29 m  
 Area: 7.60 m<sup>2</sup>  
 Perimeter: 11.21 m

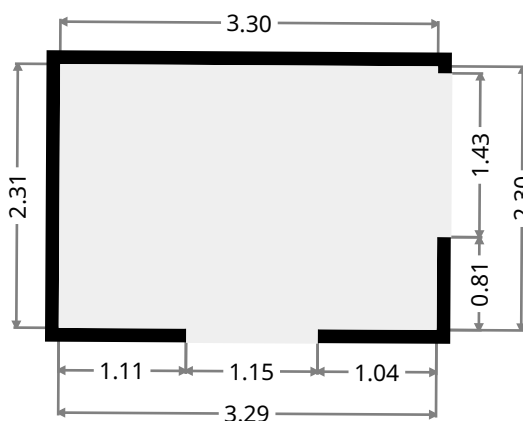
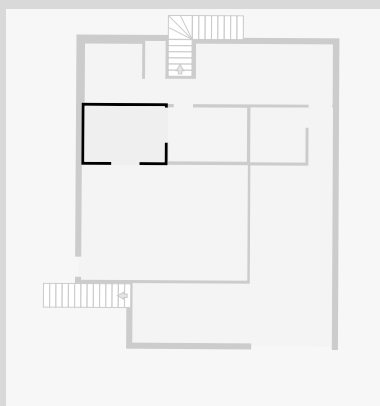

# 17 Cowap Street

## Kitchenette

Width: 2.22 m  
Length: 3.24 m  
Area: 7.21 m<sup>2</sup>  
Perimeter: 10.93 m

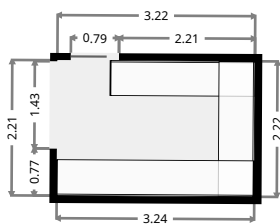
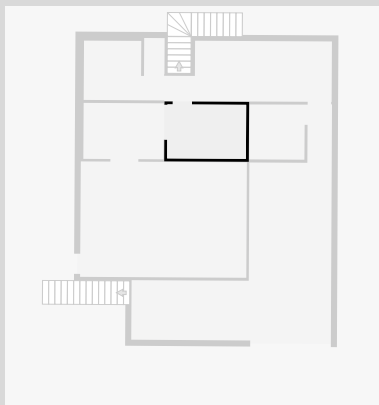

## Garage

Width: 8.22 m  
Length: 9.75 m  
Area: 39.08 m<sup>2</sup>  
Perimeter: 35.89 m

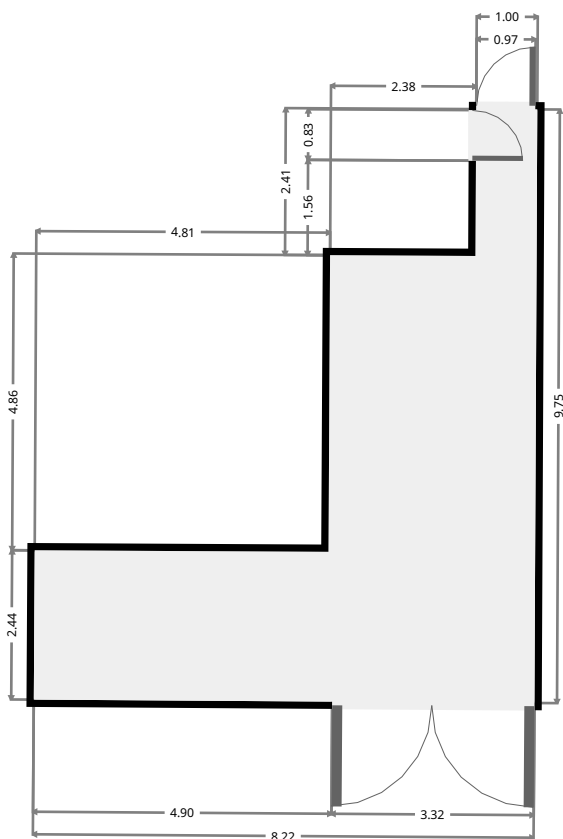
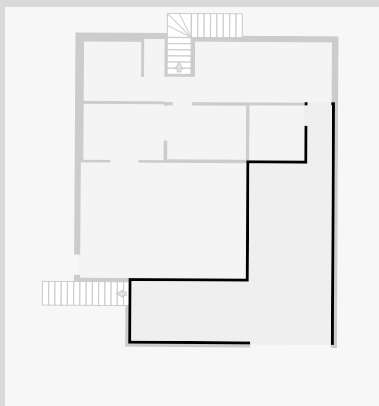

THIS FLOORPLAN IS PROVIDED WITHOUT WARRANTY OF ANY KIND. SENSOPIA DISCLAIMS ANY WARRANTY INCLUDING, WITHOUT LIMITATION, SATISFACTORY QUALITY OR ACCURACY OF DIMENSIONS.

# 17 Cowap Street

## Storage

Width: 2.26 m  
Length: 2.27 m  
Area: 5.15 m<sup>2</sup>  
Perimeter: 9.08 m

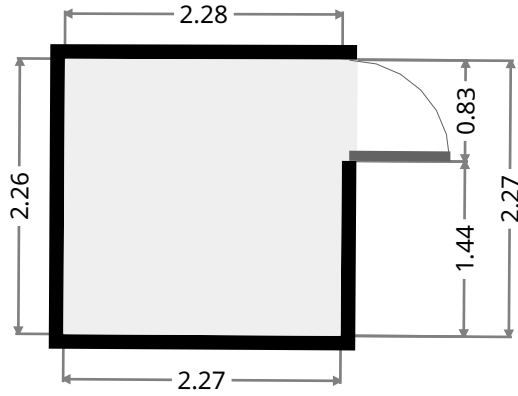
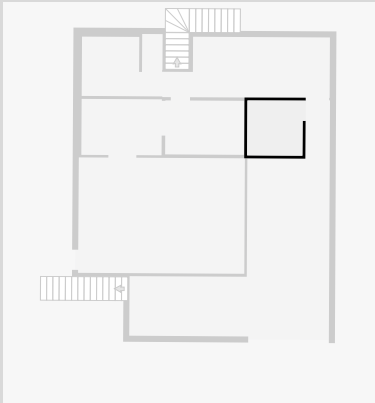

## UnderCover Area

Width: 2.49 m  
Length: 6.77 m  
Area: 15.19 m<sup>2</sup>  
Perimeter: 18.51 m

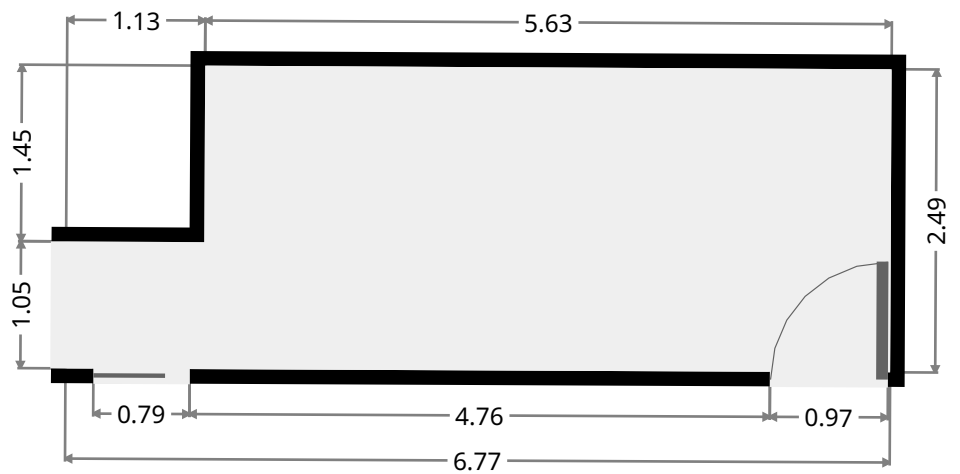
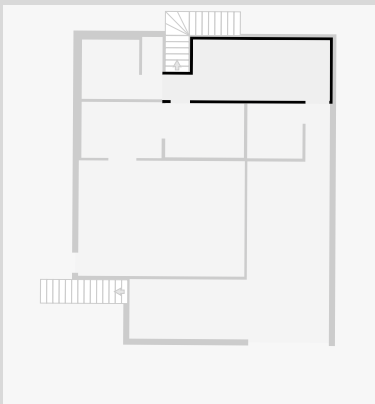

# 17 Cowap Street

## Laundry Room

Width: 2.43 m  
 Length: 3.32 m  
 Area: 6.71 m<sup>2</sup>  
 Perimeter: 11.51 m

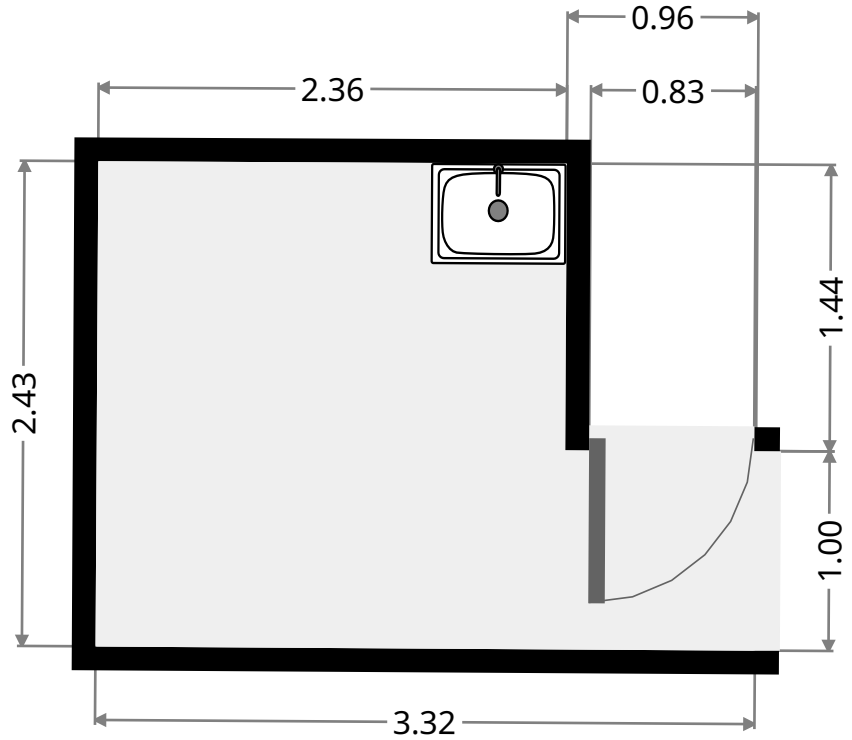
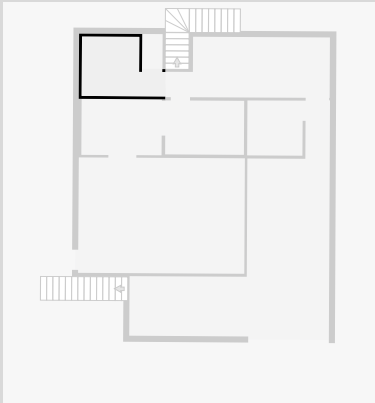

## Toilet

Width: 0.84 m  
 Length: 1.47 m  
 Area: 1.24 m<sup>2</sup>  
 Perimeter: 4.62 m

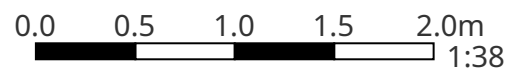
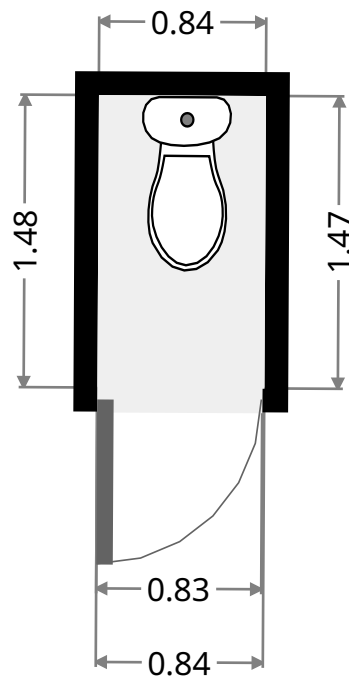
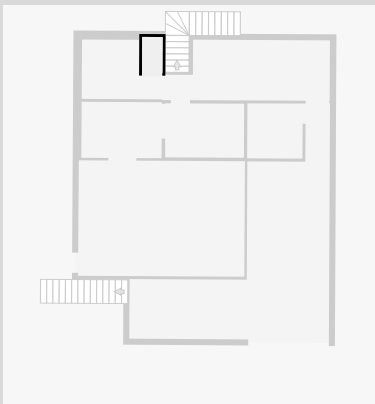

THIS FLOORPLAN IS PROVIDED WITHOUT WARRANTY OF ANY KIND. SENSOPIA DISCLAIMS ANY WARRANTY INCLUDING, WITHOUT LIMITATION, SATISFACTORY QUALITY OR ACCURACY OF DIMENSIONS.

# 17 Cowap Street

## 1st Floor

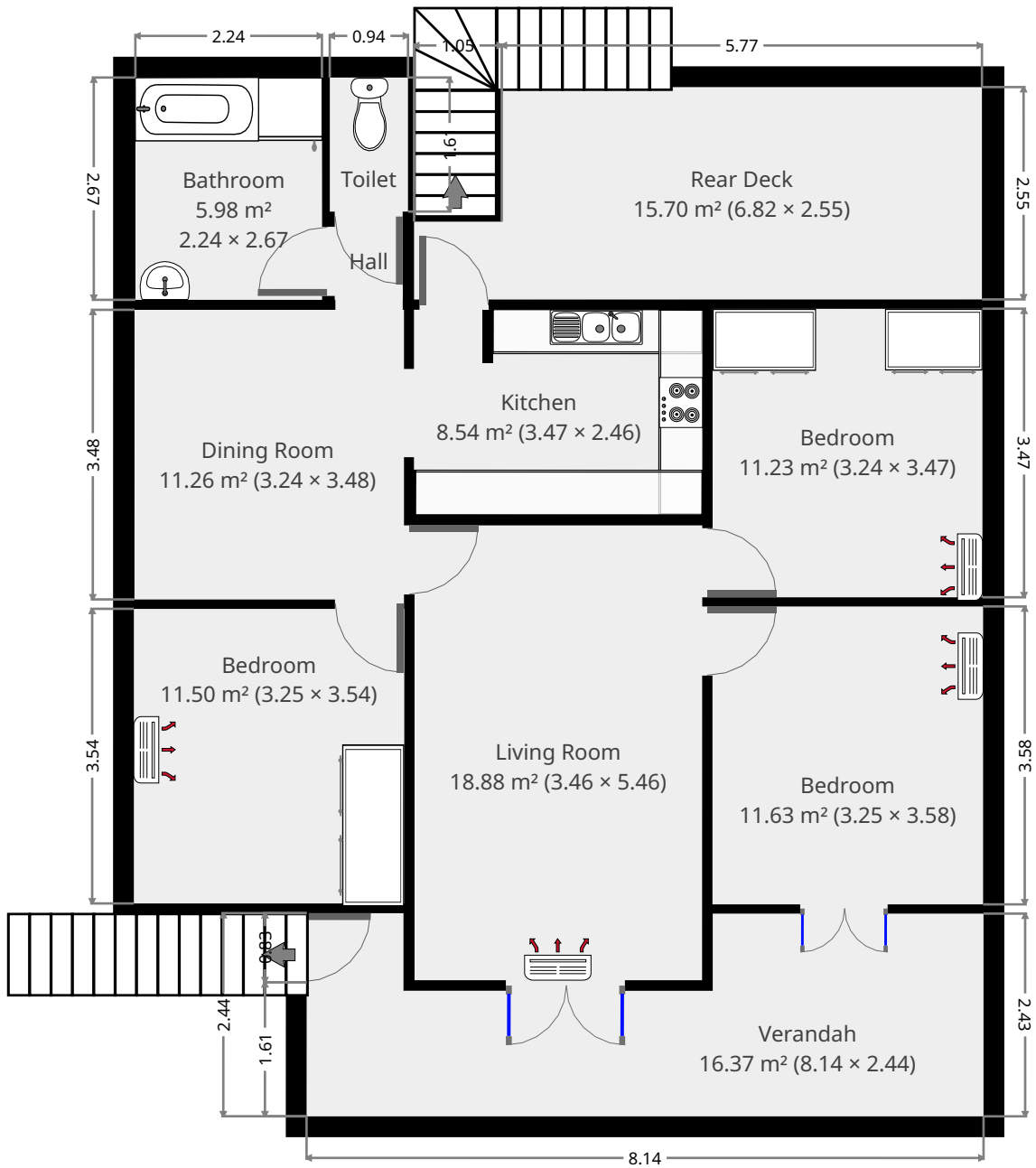

THIS FLOORPLAN IS PROVIDED WITHOUT WARRANTY OF ANY KIND. SENSOPIA DISCLAIMS ANY WARRANTY INCLUDING, WITHOUT LIMITATION, SATISFACTORY QUALITY OR ACCURACY OF DIMENSIONS.



# 17 Cowap Street

## Verandah

Width: 2.44 m  
 Length: 8.14 m  
 Area: 16.37 m<sup>2</sup>  
 Perimeter: 23.00 m

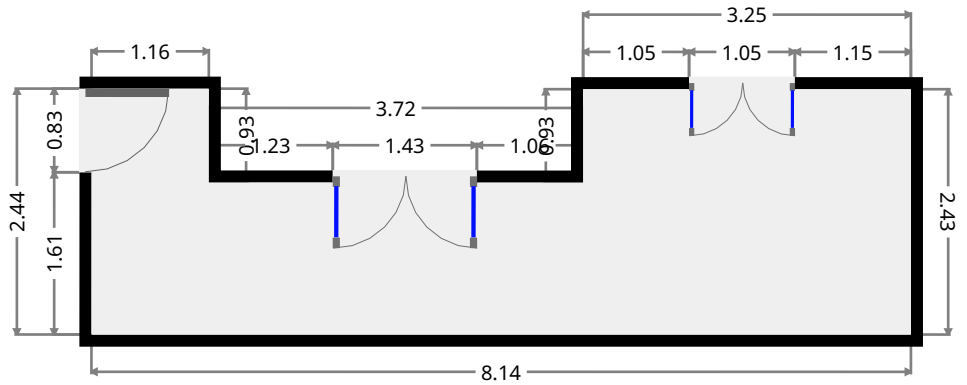
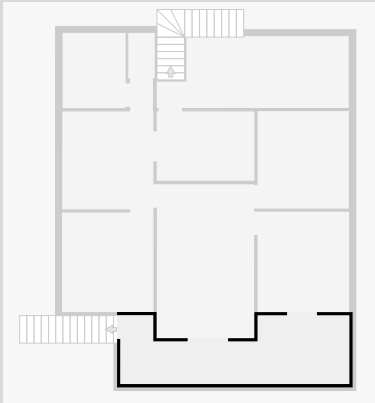

## Living Room

Width: 3.46 m  
 Length: 5.46 m  
 Area: 18.88 m<sup>2</sup>  
 Perimeter: 17.84 m

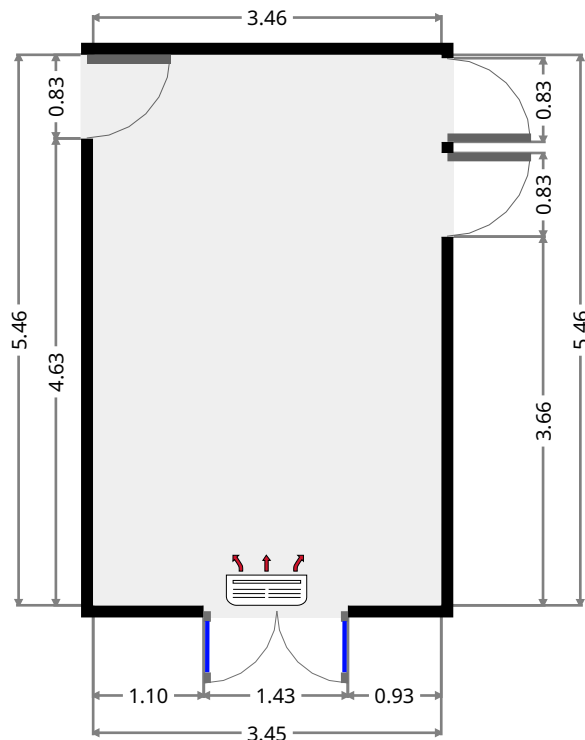
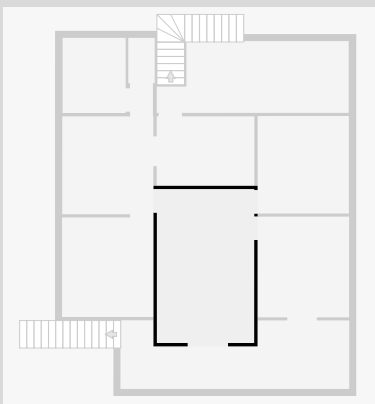

THIS FLOORPLAN IS PROVIDED WITHOUT WARRANTY OF ANY KIND. SENSOPIA DISCLAIMS ANY WARRANTY INCLUDING, WITHOUT LIMITATION, SATISFACTORY QUALITY OR ACCURACY OF DIMENSIONS.

# 17 Cowap Street

## Bedroom

Width: 3.25 m  
 Length: 3.58 m  
 Area: 11.63 m<sup>2</sup>  
 Perimeter: 13.66 m

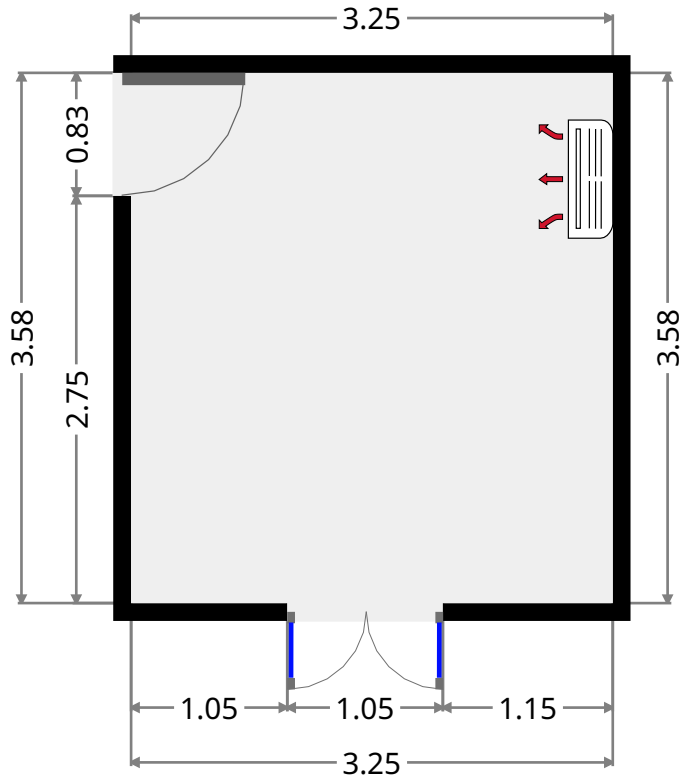
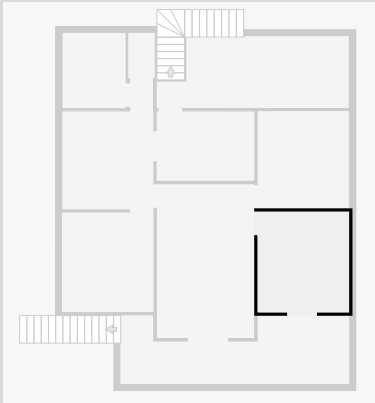

## Bedroom

Width: 3.24 m  
 Length: 3.47 m  
 Area: 11.23 m<sup>2</sup>  
 Perimeter: 13.41 m

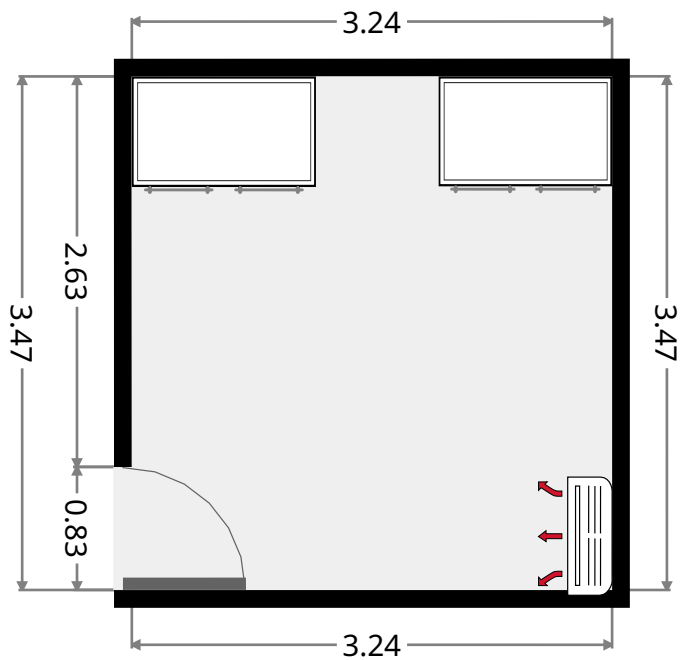
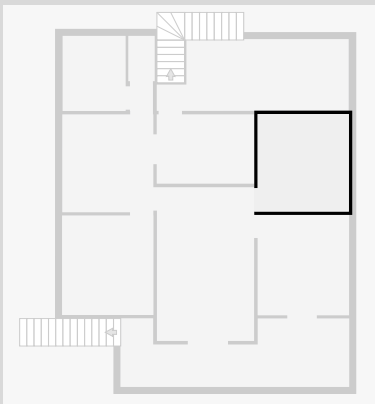



# 17 Cowap Street

## Dining Room

Width: 3.24 m  
 Length: 3.48 m  
 Area: 11.26 m<sup>2</sup>  
 Perimeter: 13.43 m

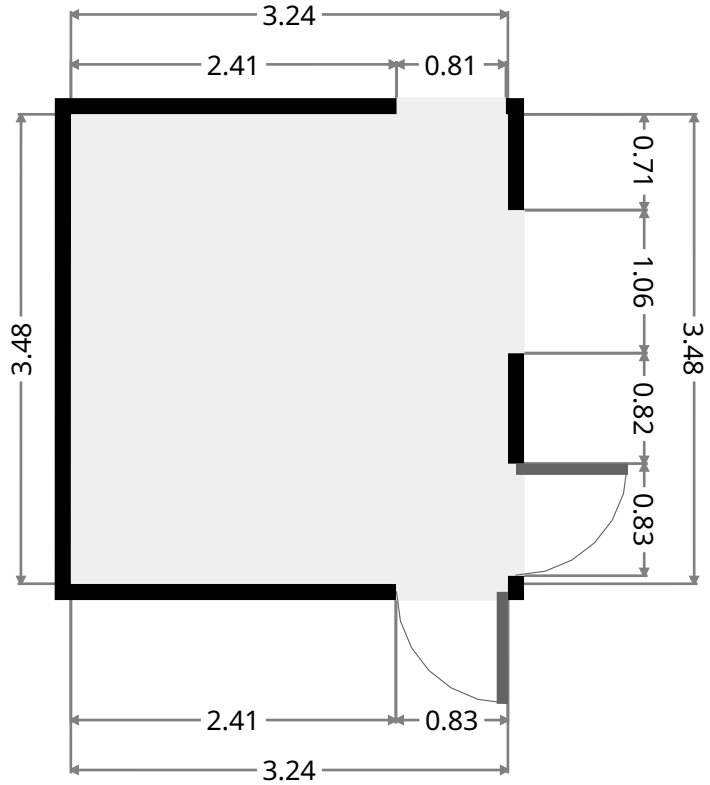
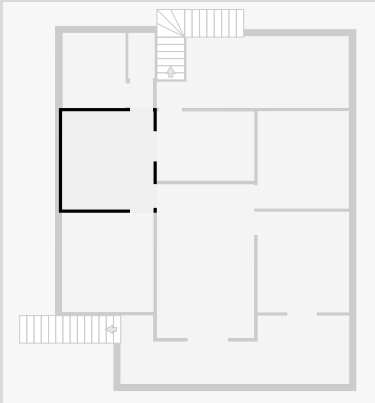

## Bedroom

Width: 3.25 m  
 Length: 3.54 m  
 Area: 11.50 m<sup>2</sup>  
 Perimeter: 13.58 m

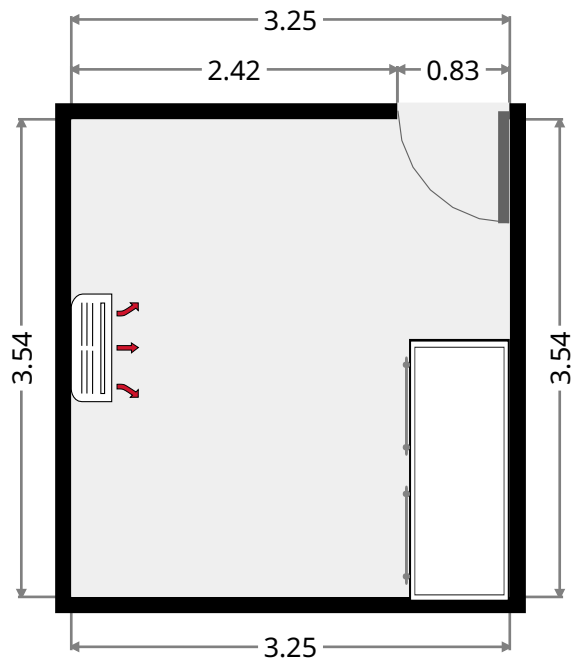
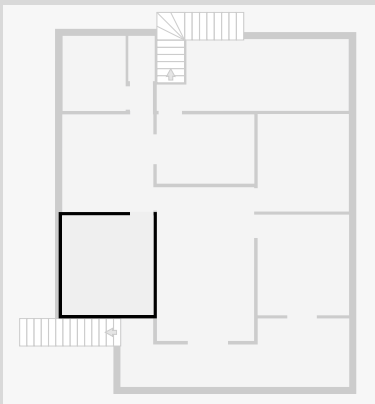

# 17 Cowap Street

## Kitchen

Width: 2.46 m  
 Length: 3.47 m  
 Area: 8.54 m<sup>2</sup>  
 Perimeter: 11.86 m

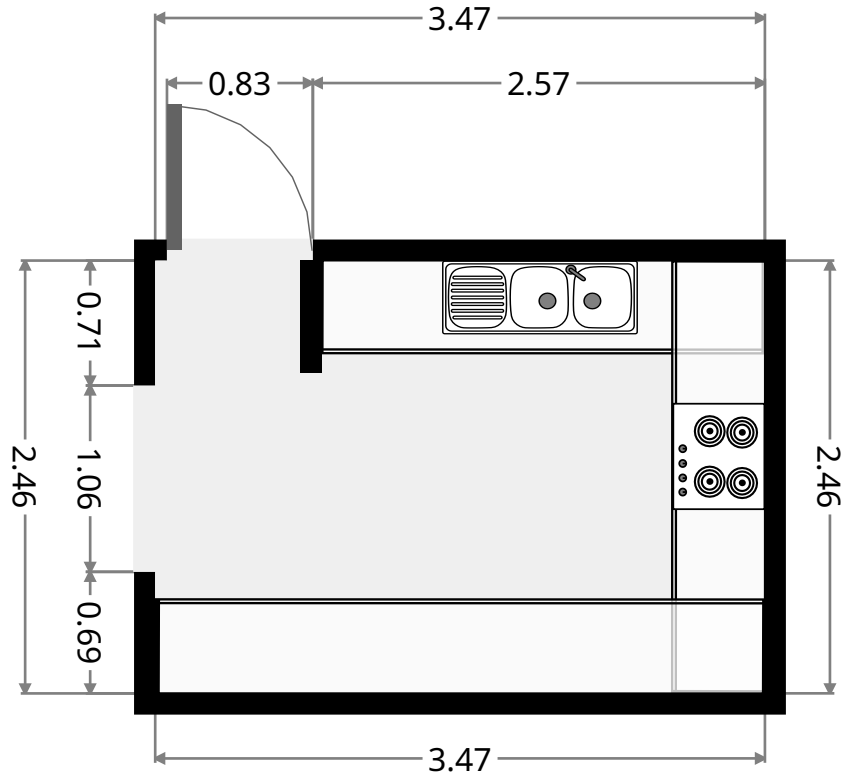
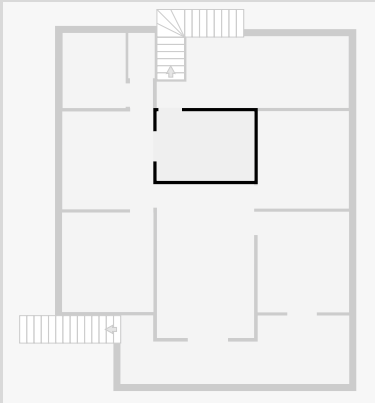

## Hall

Width: 0.82 m  
 Length: 0.94 m  
 Area: 0.77 m<sup>2</sup>  
 Perimeter: 3.52 m

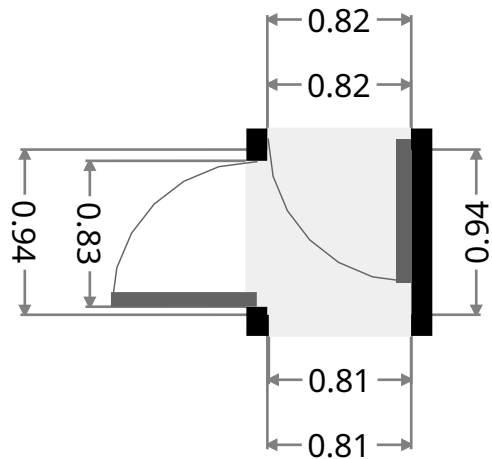
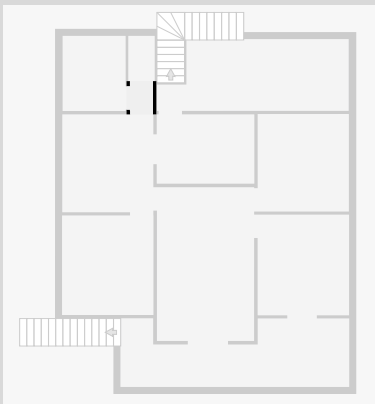

# 17 Cowap Street

## Toilet

Width: 0.94 m  
 Length: 1.61 m  
 Area: 1.51 m<sup>2</sup>  
 Perimeter: 5.10 m

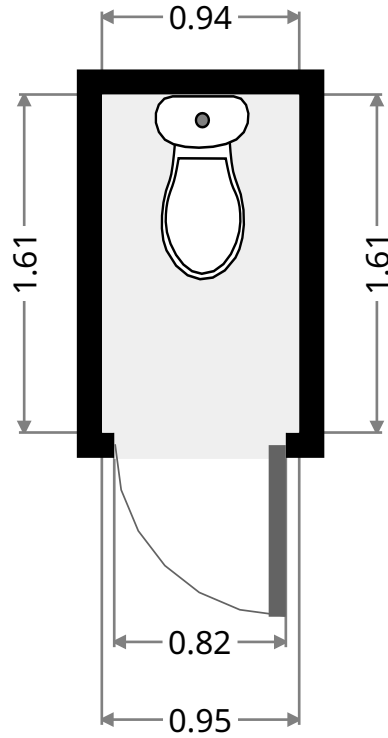
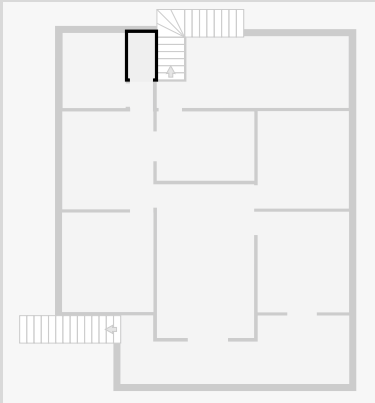

## Bathroom

Width: 2.24 m  
 Length: 2.67 m  
 Area: 5.98 m<sup>2</sup>  
 Perimeter: 9.82 m

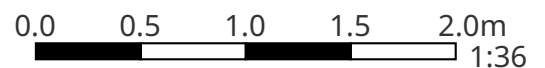
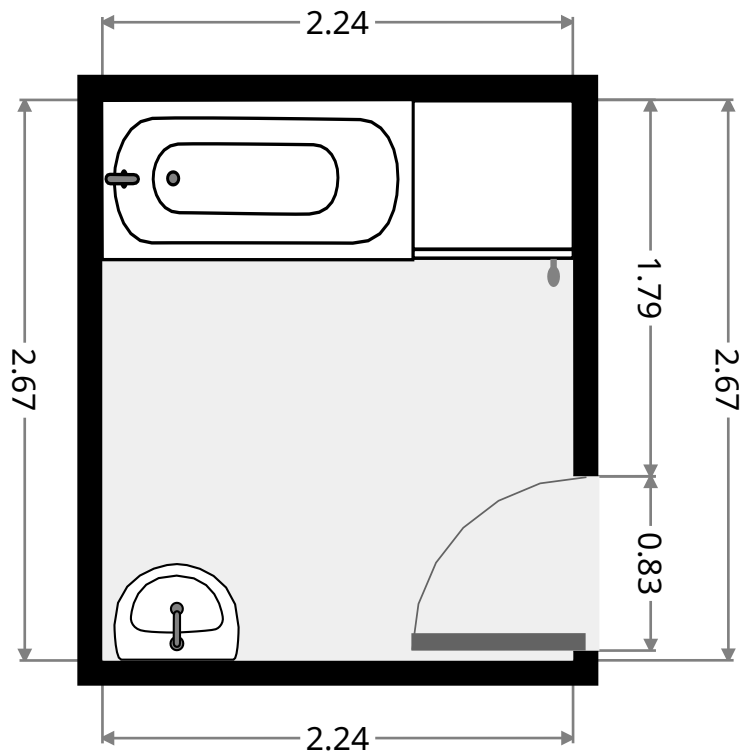
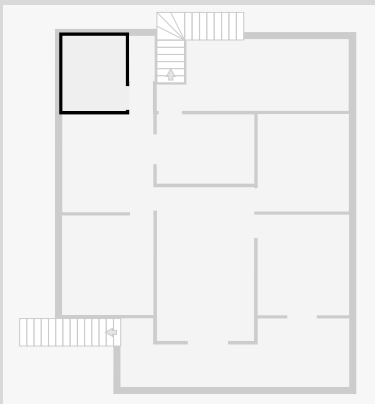

THIS FLOORPLAN IS PROVIDED WITHOUT WARRANTY OF ANY KIND. SENSOPIA DISCLAIMS ANY WARRANTY INCLUDING, WITHOUT LIMITATION, SATISFACTORY QUALITY OR ACCURACY OF DIMENSIONS.

# 17 Cowap Street

## Rear Deck

Width: 2.55 m  
Length: 6.82 m  
Area: 15.70 m<sup>2</sup>  
Perimeter: 18.74 m

