

17 Cascade Close

Ground Floor

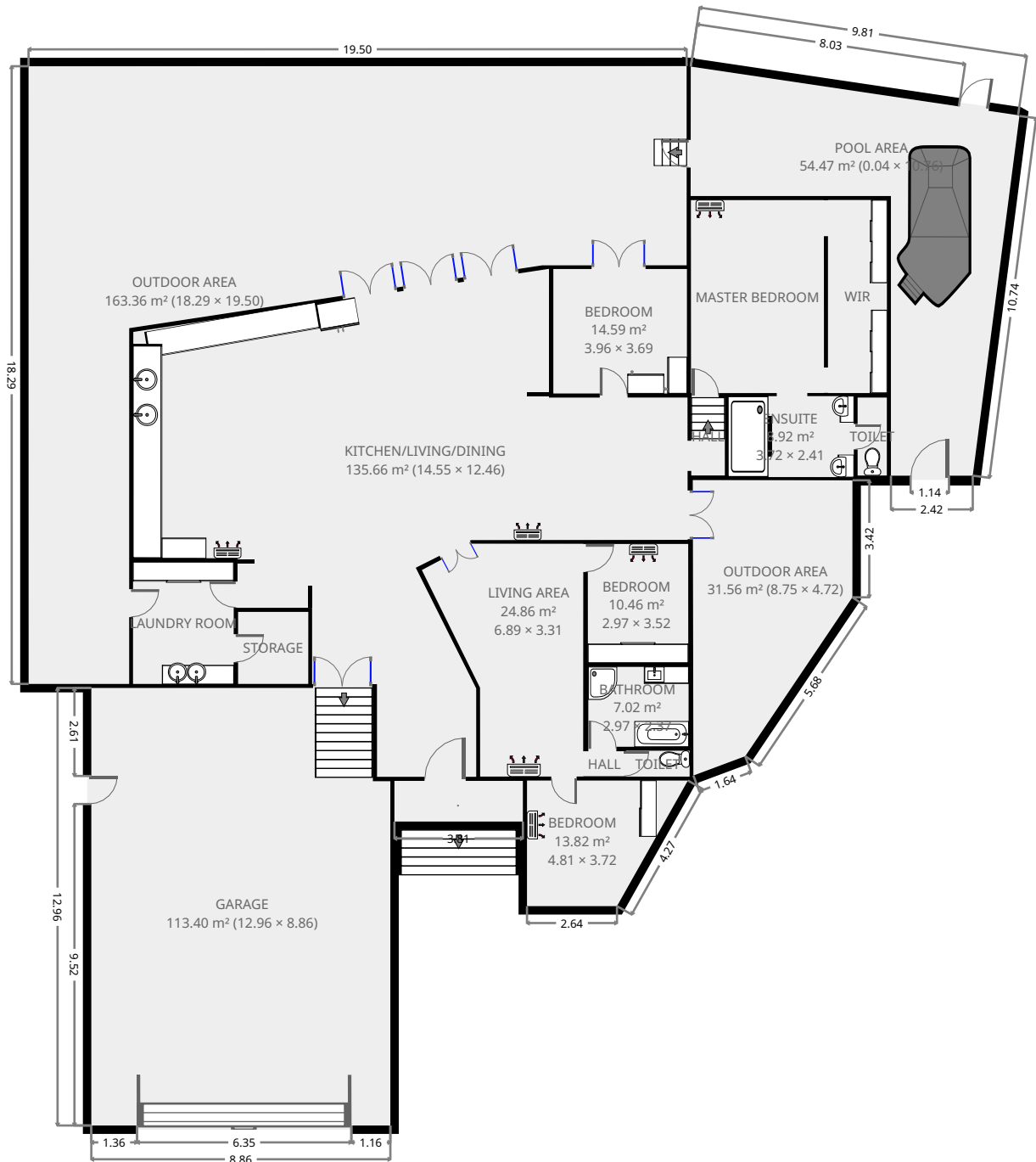

THIS FLOORPLAN IS PROVIDED WITHOUT WARRANTY OF ANY KIND. SENSOPIA DISCLAIMS ANY WARRANTY INCLUDING, WITHOUT LIMITATION, SATISFACTORY QUALITY OR ACCURACY OF DIMENSIONS.

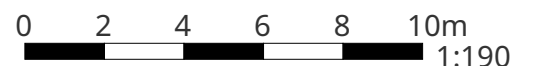

17 Cascade Close

Bedroom

Width: 3.69 m
 Length: 3.96 m
 Area: 14.59 m²
 Perimeter: 15.29 m

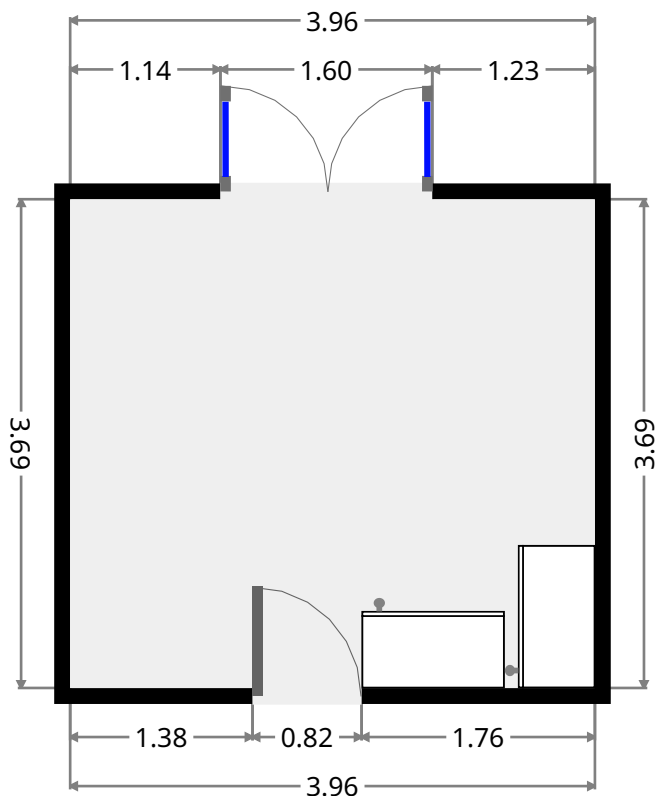
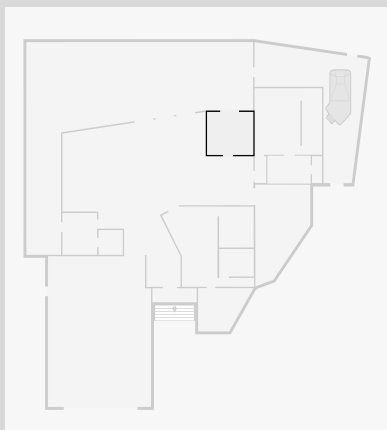

•
 Width: 1.21 m
 Length: 3.81 m
 Area: 4.58 m²
 Perimeter: 10.02 m

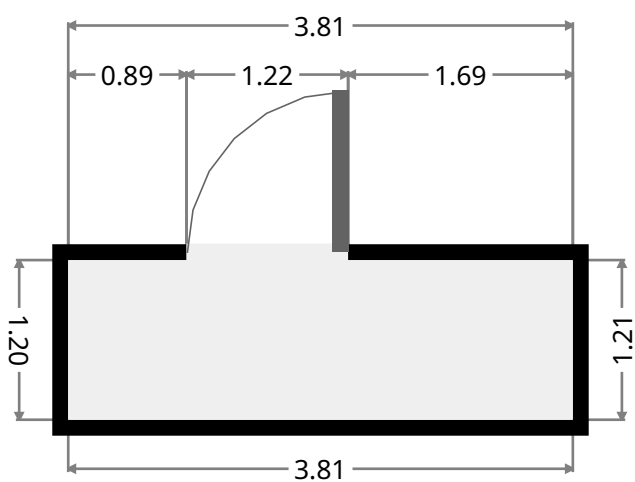
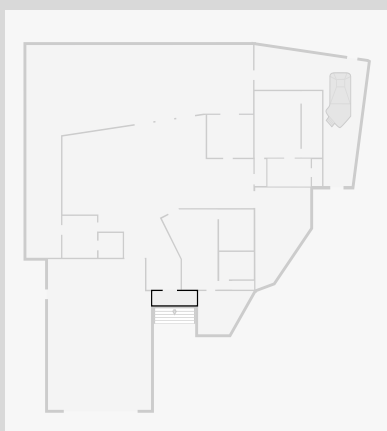

17 Cascade Close

Outdoor Area

Width: 4.72 m
 Length: 8.75 m
 Area: 31.56 m²
 Perimeter: 24.26 m

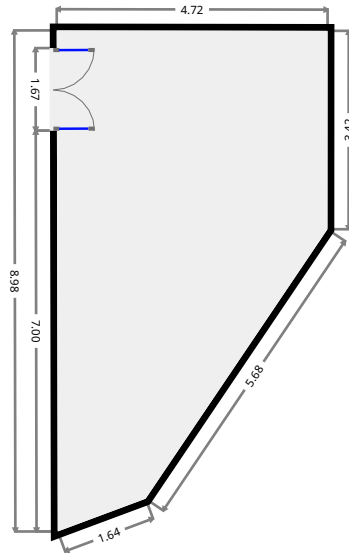
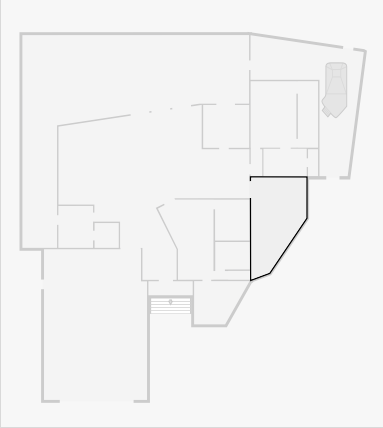

Pool Area

Width: 0.04 m
 Length: 10.76 m
 Area: 54.47 m²
 Perimeter: 41.07 m

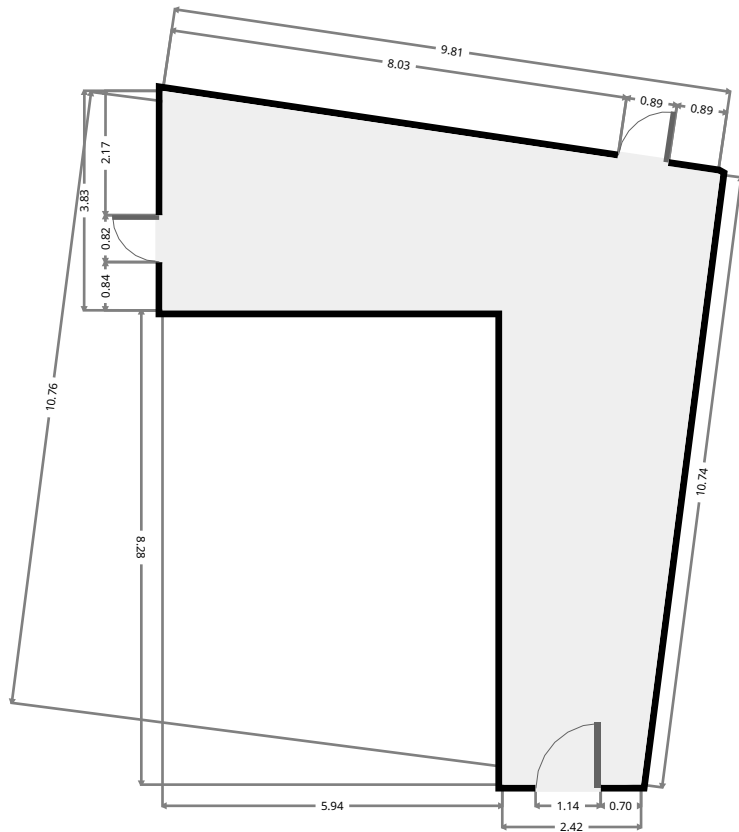
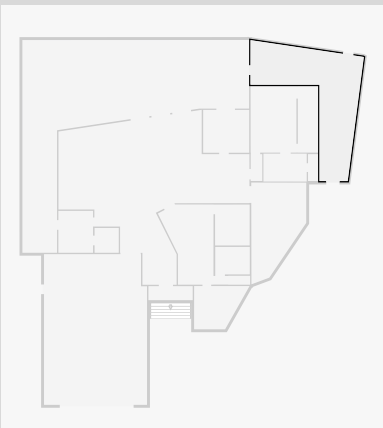

THIS FLOORPLAN IS PROVIDED WITHOUT WARRANTY OF ANY KIND. SENSOPIA DISCLAIMS ANY WARRANTY INCLUDING, WITHOUT LIMITATION, SATISFACTORY QUALITY OR ACCURACY OF DIMENSIONS.

17 Cascade Close

Outdoor Area

Width: 18.29 m
 Length: 19.50 m
 Area: 163.36 m²
 Perimeter: 73.87 m

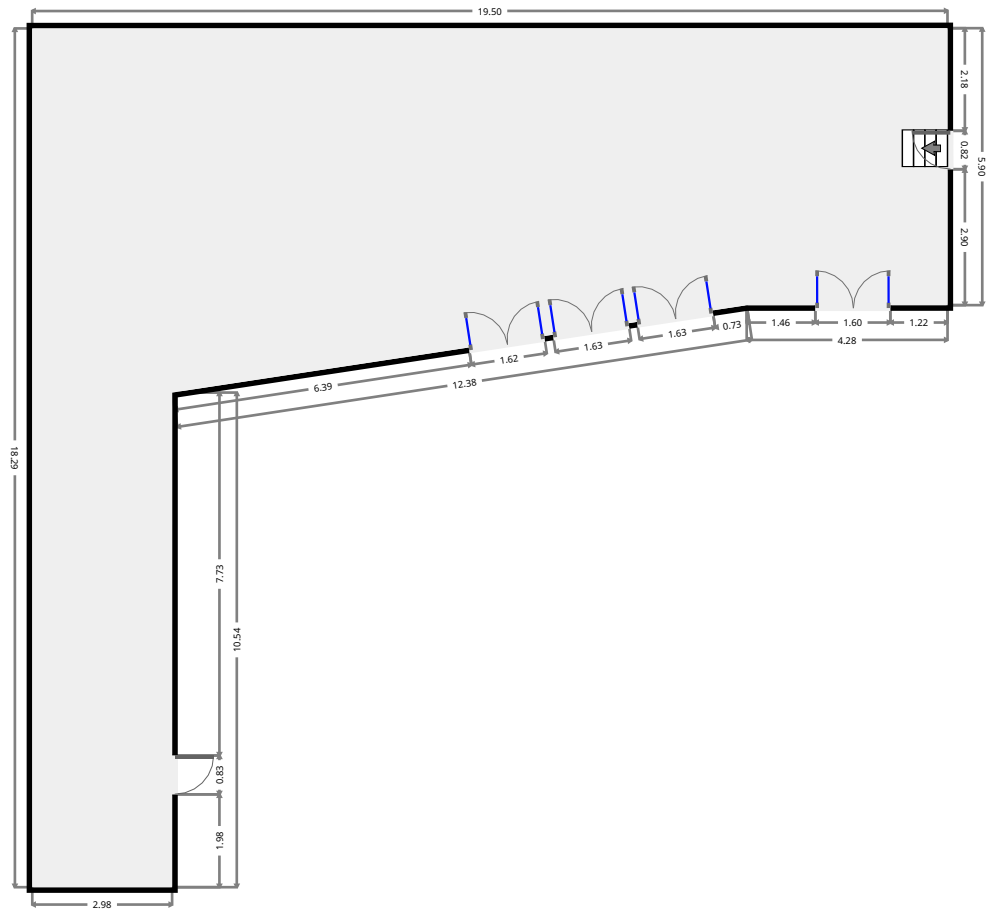
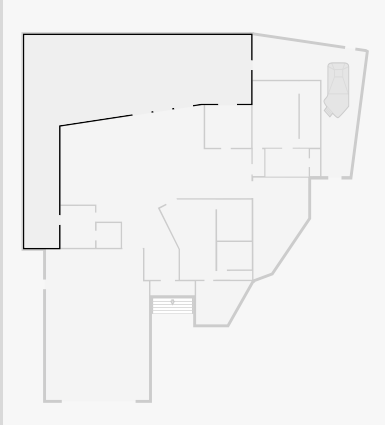

THIS FLOORPLAN IS PROVIDED WITHOUT WARRANTY OF ANY KIND. SENSOPIA DISCLAIMS ANY WARRANTY INCLUDING, WITHOUT LIMITATION, SATISFACTORY QUALITY OR ACCURACY OF DIMENSIONS.



17 Cascade Close

Toilet

Width: 0.87 m
 Length: 2.30 m
 Area: 2.00 m²
 Perimeter: 6.35 m

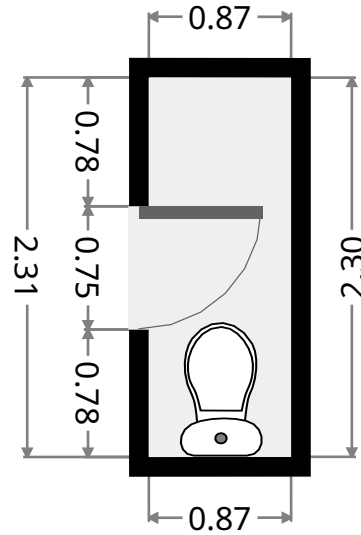
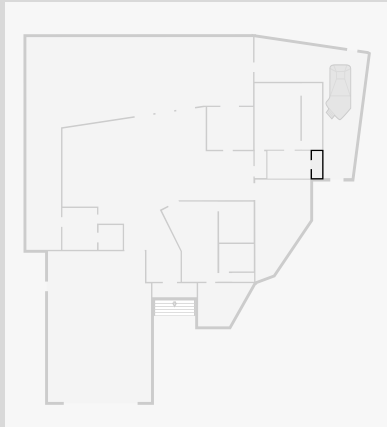

Ensuite

Width: 2.41 m
 Length: 3.72 m
 Area: 8.92 m²
 Perimeter: 12.24 m

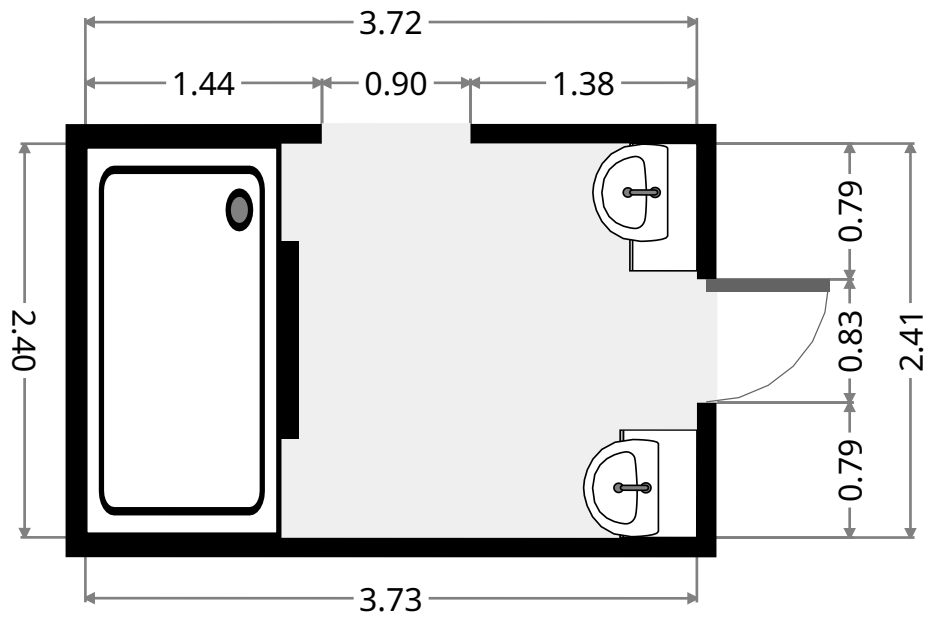
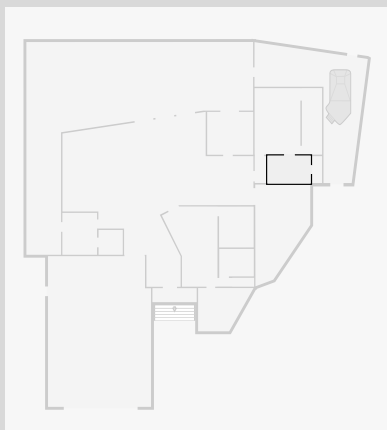

THIS FLOORPLAN IS PROVIDED WITHOUT WARRANTY OF ANY KIND. SENSOPIA DISCLAIMS ANY WARRANTY INCLUDING, WITHOUT LIMITATION, SATISFACTORY QUALITY OR ACCURACY OF DIMENSIONS.

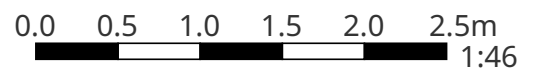

17 Cascade Close

WIR

Width: 1.75 m
 Length: 5.72 m
 Area: 9.98 m²
 Perimeter: 14.93 m

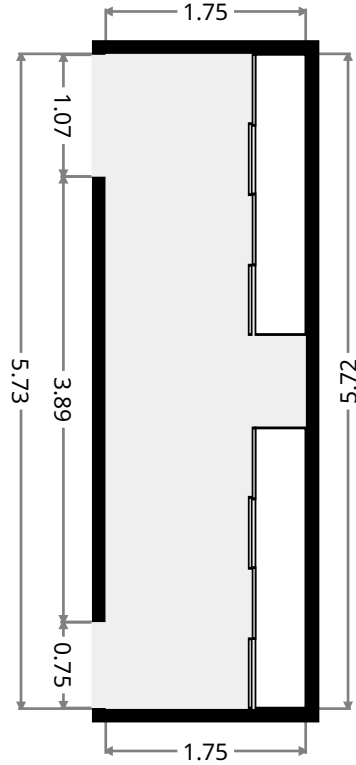
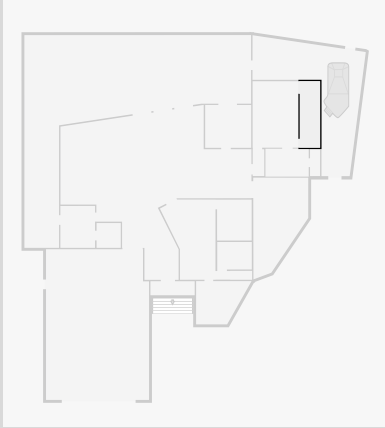

Master Bedroom

Width: 3.94 m
 Length: 5.71 m
 Area: 22.52 m²
 Perimeter: 19.31 m

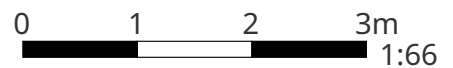
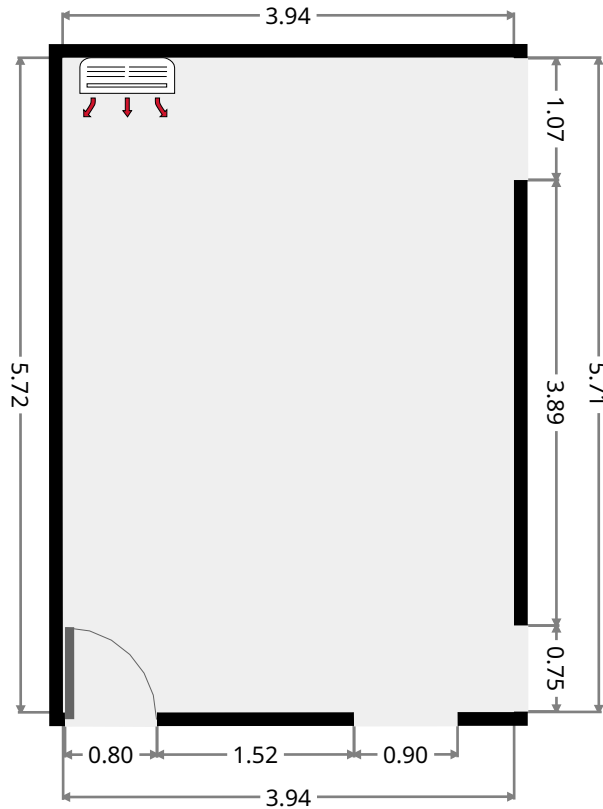
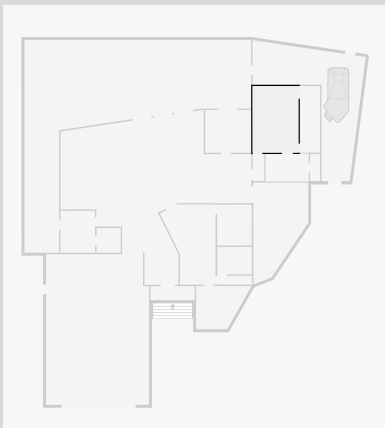

THIS FLOORPLAN IS PROVIDED WITHOUT WARRANTY OF ANY KIND. SENSOPIA DISCLAIMS ANY WARRANTY INCLUDING, WITHOUT LIMITATION, SATISFACTORY QUALITY OR ACCURACY OF DIMENSIONS.

17 Cascade Close

Hall

Width: 0.99 m
 Length: 2.30 m
 Area: 2.29 m²
 Perimeter: 6.60 m

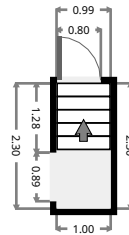
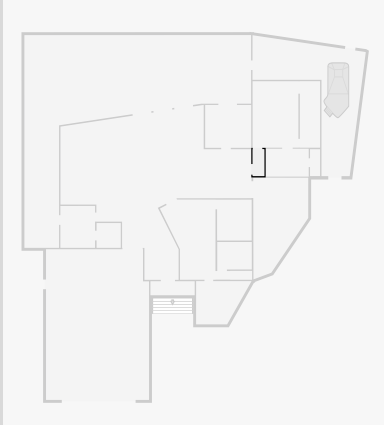

Garage

Width: 8.86 m
 Length: 12.96 m
 Area: 113.40 m²
 Perimeter: 43.64 m

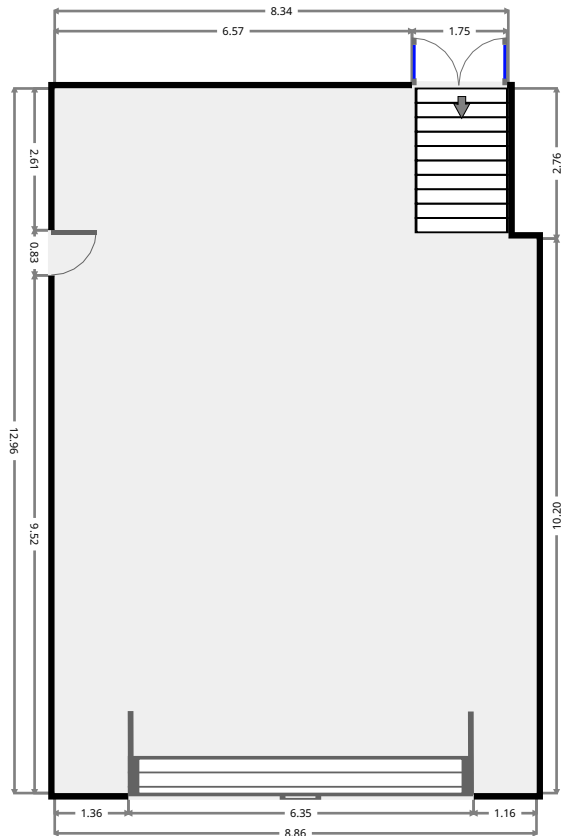
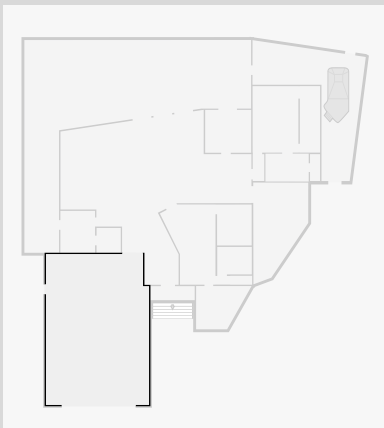

THIS FLOORPLAN IS PROVIDED WITHOUT WARRANTY OF ANY KIND. SENSOPIA DISCLAIMS ANY WARRANTY INCLUDING, WITHOUT LIMITATION, SATISFACTORY QUALITY OR ACCURACY OF DIMENSIONS.

17 Cascade Close

Bedroom

Width: 2.97 m
 Length: 3.52 m
 Area: 10.46 m²
 Perimeter: 12.98 m

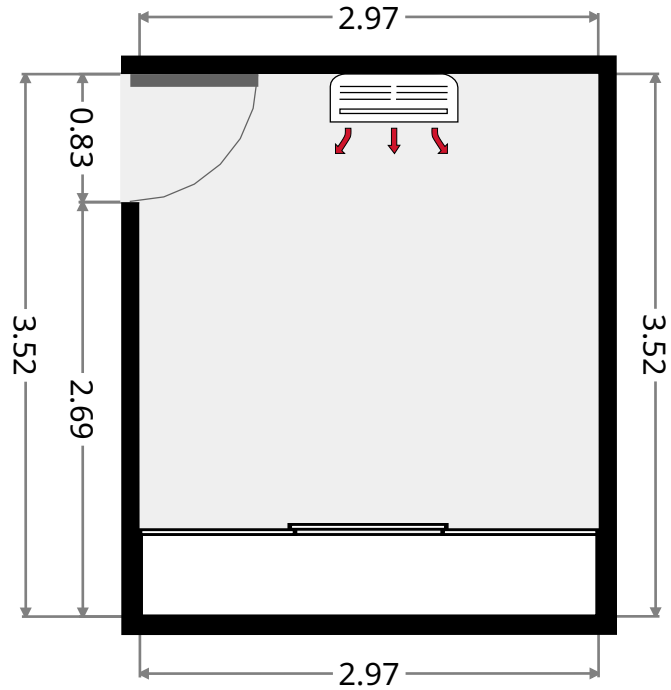
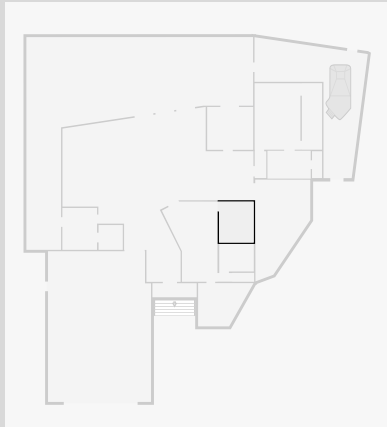

Bedroom

Width: 3.72 m
 Length: 4.81 m
 Area: 13.82 m²
 Perimeter: 15.42 m

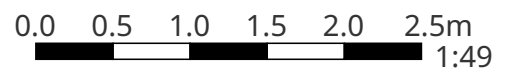
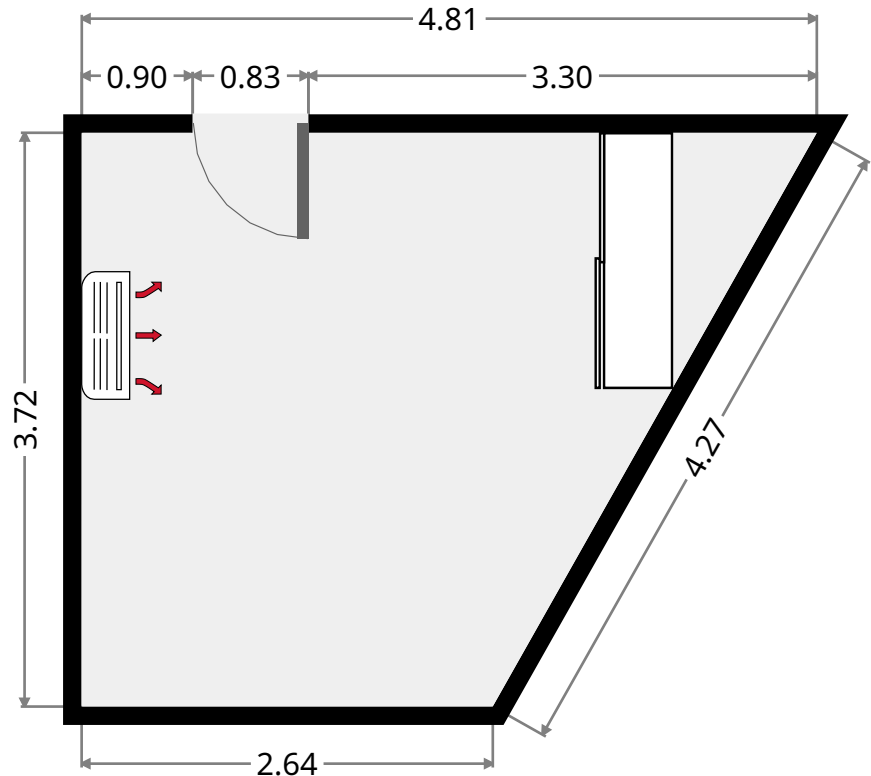
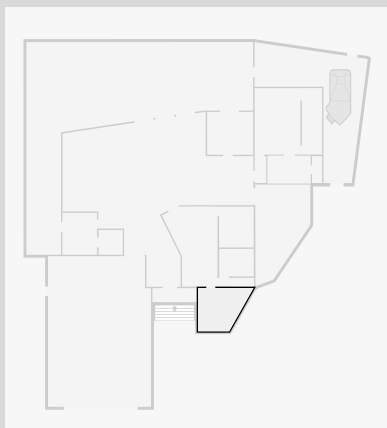

THIS FLOORPLAN IS PROVIDED WITHOUT WARRANTY OF ANY KIND. SENSOPIA DISCLAIMS ANY WARRANTY INCLUDING, WITHOUT LIMITATION, SATISFACTORY QUALITY OR ACCURACY OF DIMENSIONS.

17 Cascade Close

Toilet

Width: 0.77 m
 Length: 1.89 m
 Area: 1.45 m²
 Perimeter: 5.31 m

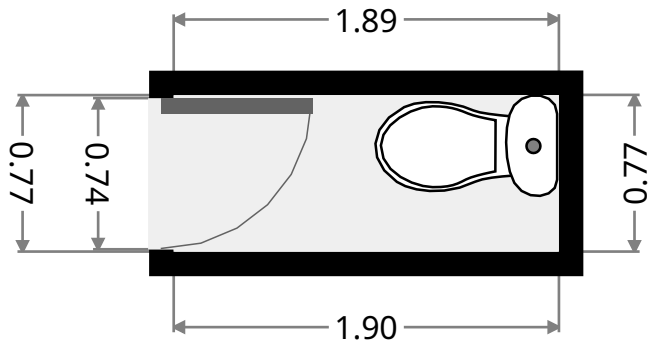
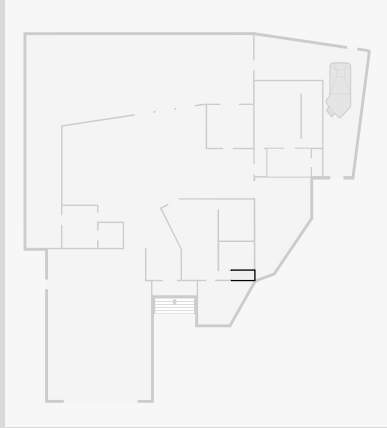

Bathroom

Width: 2.37 m
 Length: 2.97 m
 Area: 7.02 m²
 Perimeter: 10.67 m

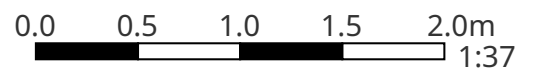
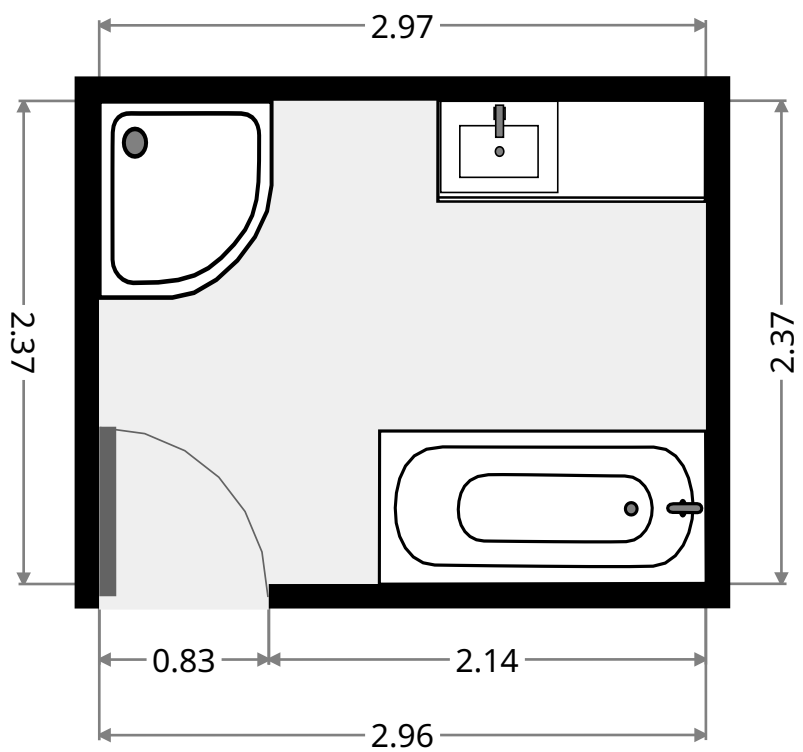
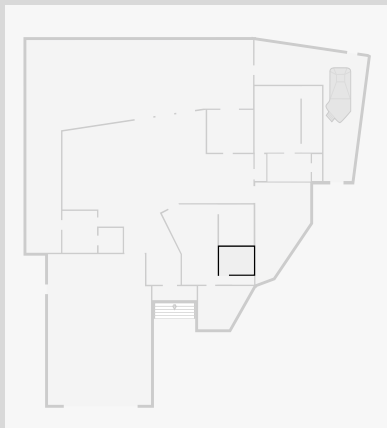

THIS FLOORPLAN IS PROVIDED WITHOUT WARRANTY OF ANY KIND. SENSOPIA DISCLAIMS ANY WARRANTY INCLUDING, WITHOUT LIMITATION, SATISFACTORY QUALITY OR ACCURACY OF DIMENSIONS.

17 Cascade Close

Hall

Width: 0.74 m
 Length: 1.08 m
 Area: 0.80 m²
 Perimeter: 3.64 m

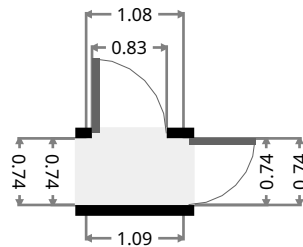
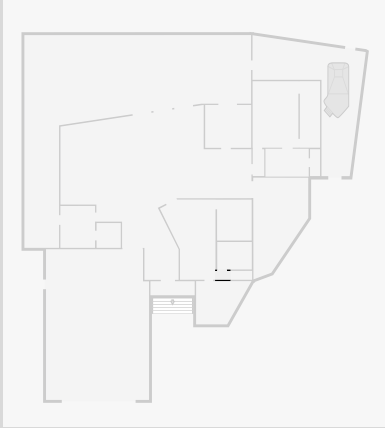

Living Area

Width: 3.31 m
 Length: 6.89 m
 Area: 24.86 m²
 Perimeter: 21.44 m

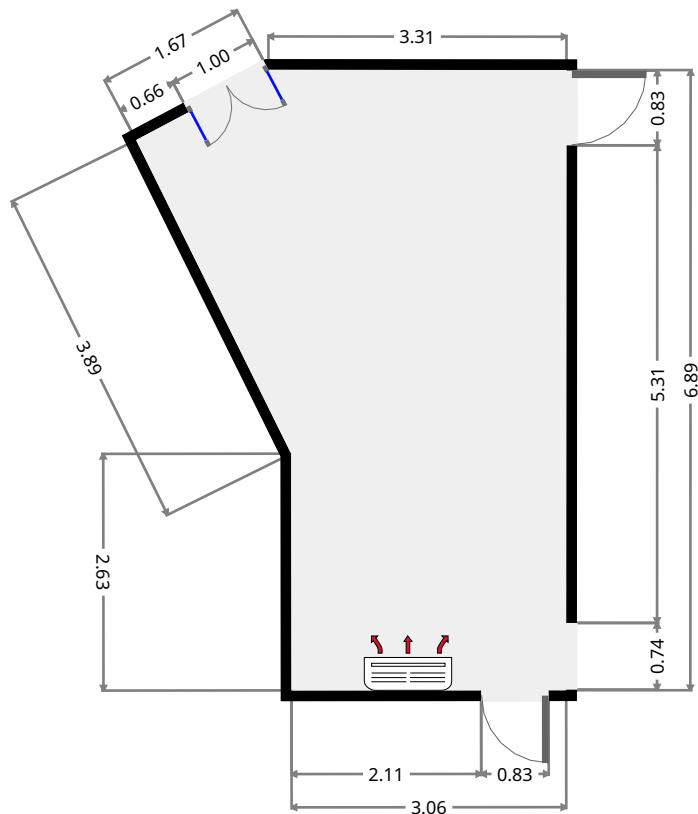
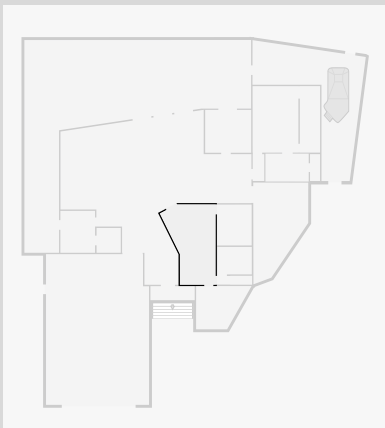

THIS FLOORPLAN IS PROVIDED WITHOUT WARRANTY OF ANY KIND. SENSOPIA DISCLAIMS ANY WARRANTY INCLUDING, WITHOUT LIMITATION, SATISFACTORY QUALITY OR ACCURACY OF DIMENSIONS.

17 Cascade Close

Storage

Width: 2.08 m
 Length: 2.13 m
 Area: 4.44 m²
 Perimeter: 8.43 m

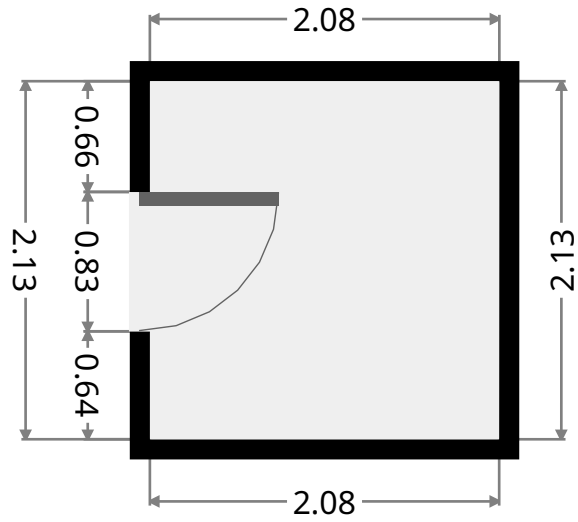
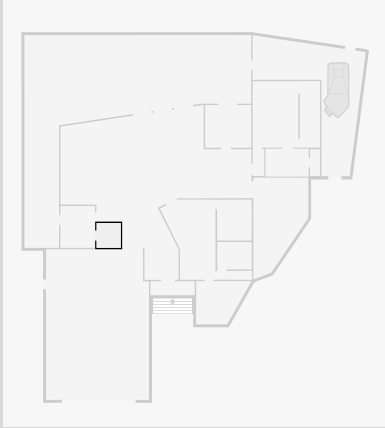

Laundry Room

Width: 2.98 m
 Length: 3.60 m
 Area: 10.75 m²
 Perimeter: 13.17 m

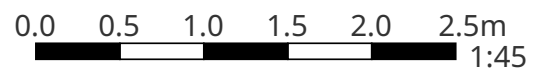
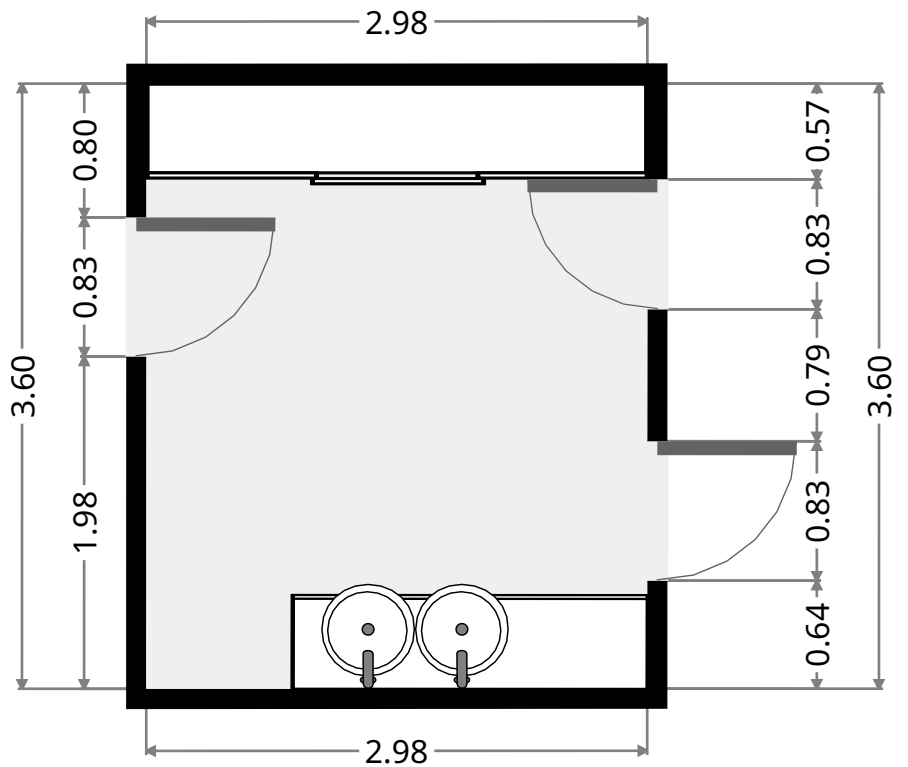
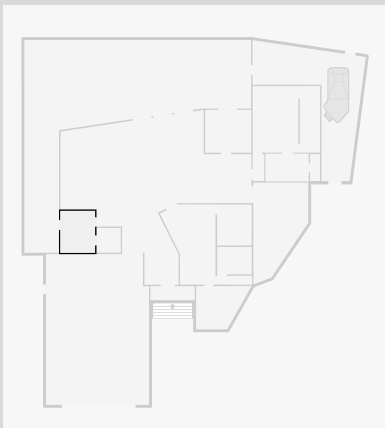

THIS FLOORPLAN IS PROVIDED WITHOUT WARRANTY OF ANY KIND. SENSOPIA DISCLAIMS ANY WARRANTY INCLUDING, WITHOUT LIMITATION, SATISFACTORY QUALITY OR ACCURACY OF DIMENSIONS.

17 Cascade Close

Kitchen/Living/Dining

Width: 12.46 m
 Length: 14.55 m
 Area: 135.66 m²
 Perimeter: 62.79 m

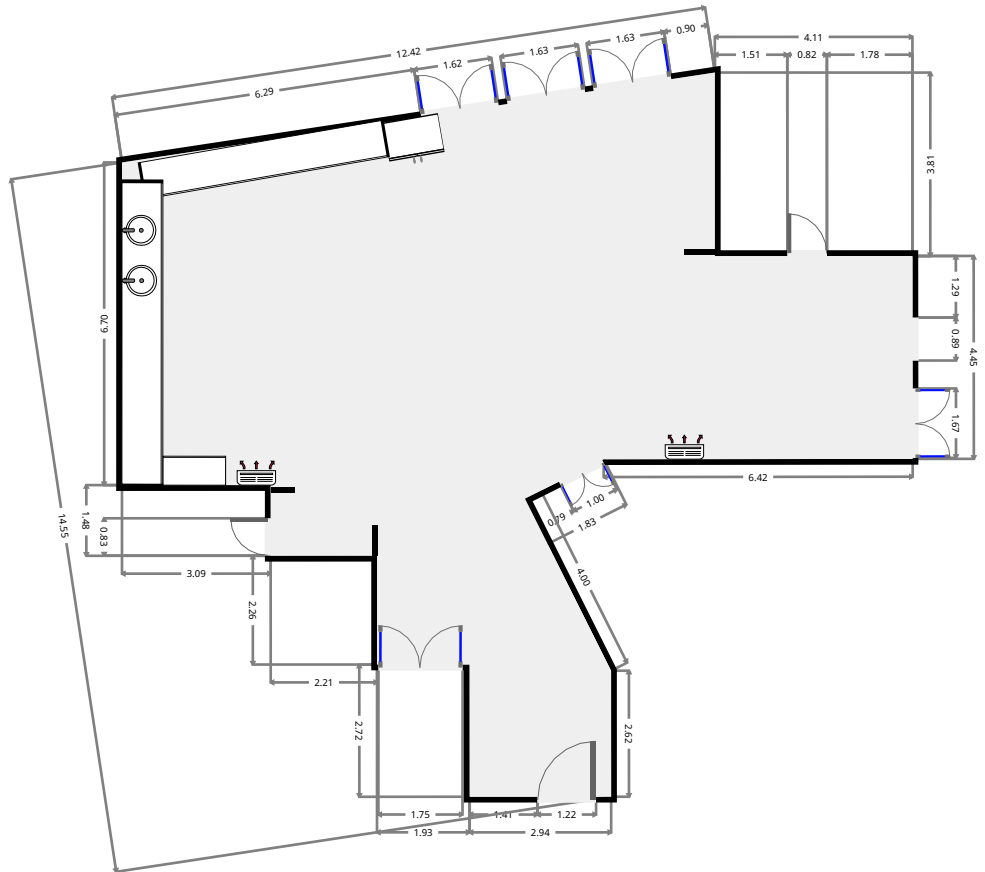
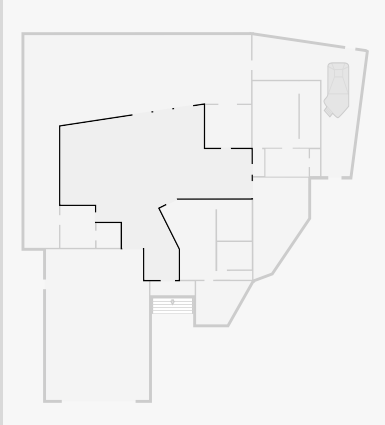

THIS FLOORPLAN IS PROVIDED WITHOUT WARRANTY OF ANY KIND. SENSOPIA DISCLAIMS ANY WARRANTY INCLUDING, WITHOUT LIMITATION, SATISFACTORY QUALITY OR ACCURACY OF DIMENSIONS.

