

17 Belmont Road

Created on
2019-03-26

Floors
2

▼ Ground Floor

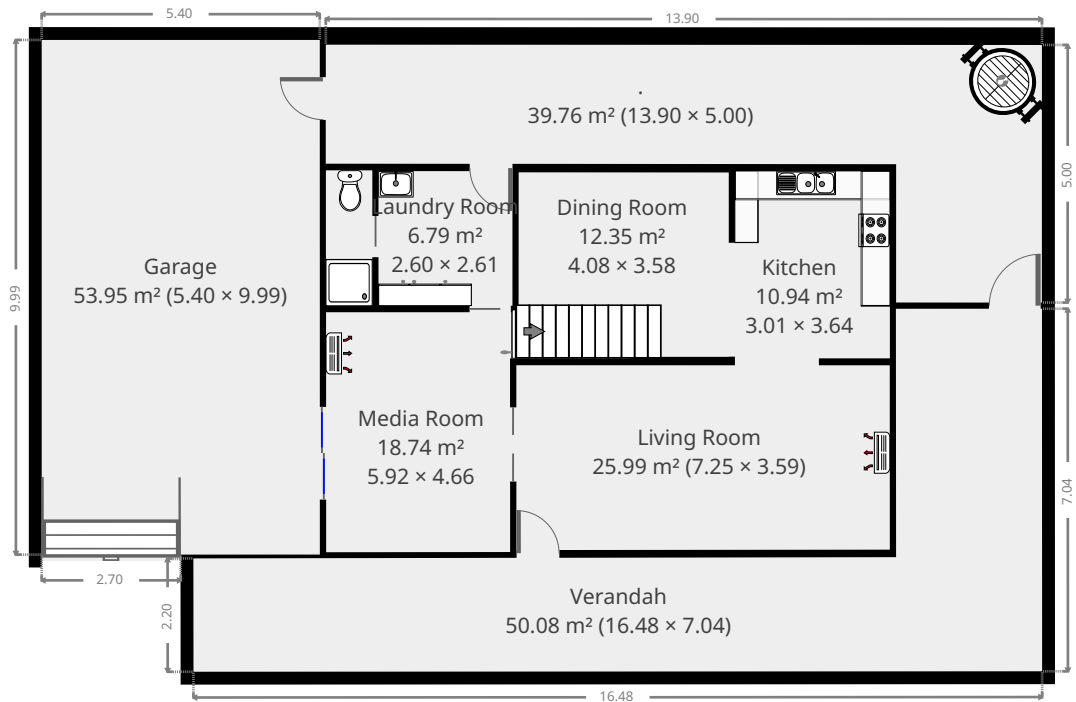
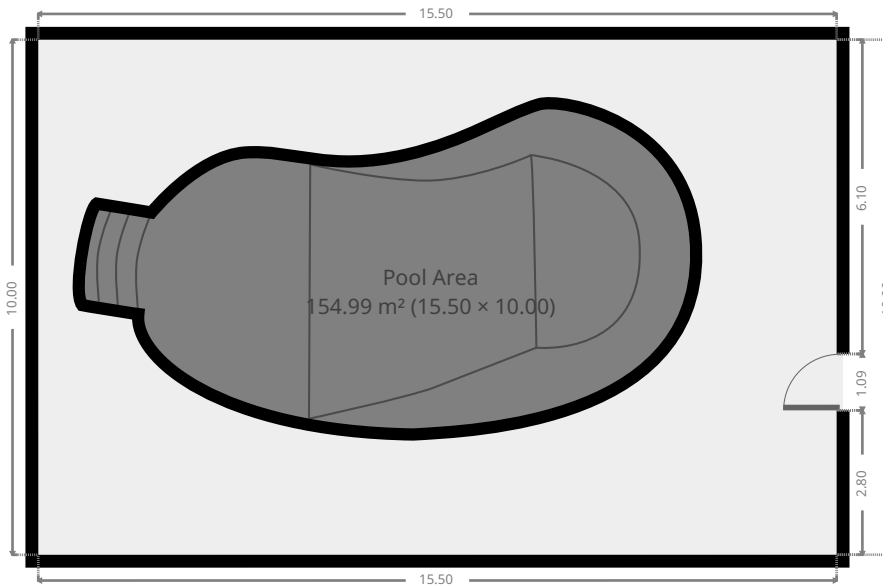

FLOORS: 2

▼ Living Room Ground Floor

WIDTH: 7.25 m • **LENGTH:** 3.59 m
AREA: 25.99 m² • **PERIMETER:** 21.67 m

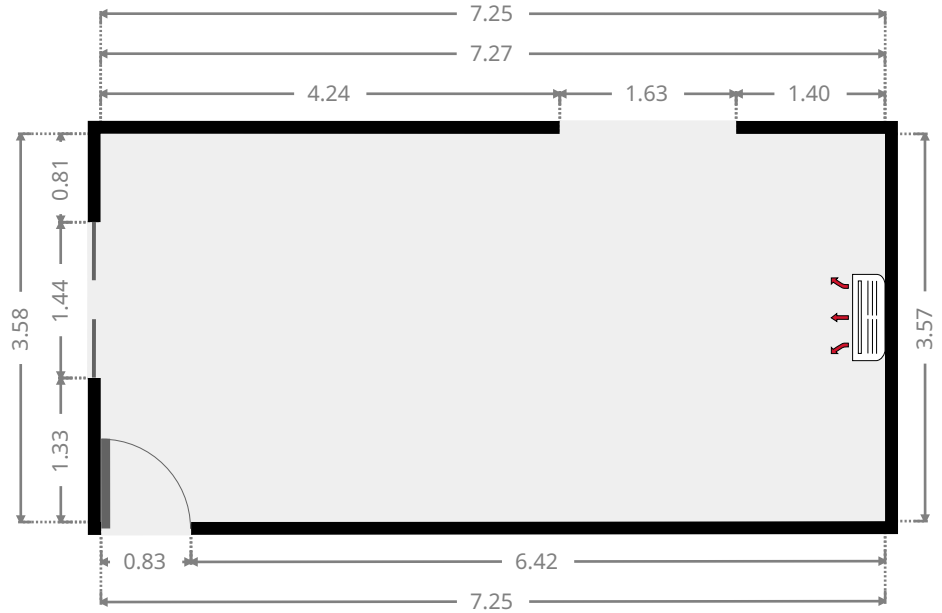
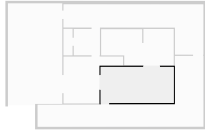

▼ Media Room Ground Floor

WIDTH: 5.92 m • **LENGTH:** 4.66 m
AREA: 18.74 m² • **PERIMETER:** 21.15 m

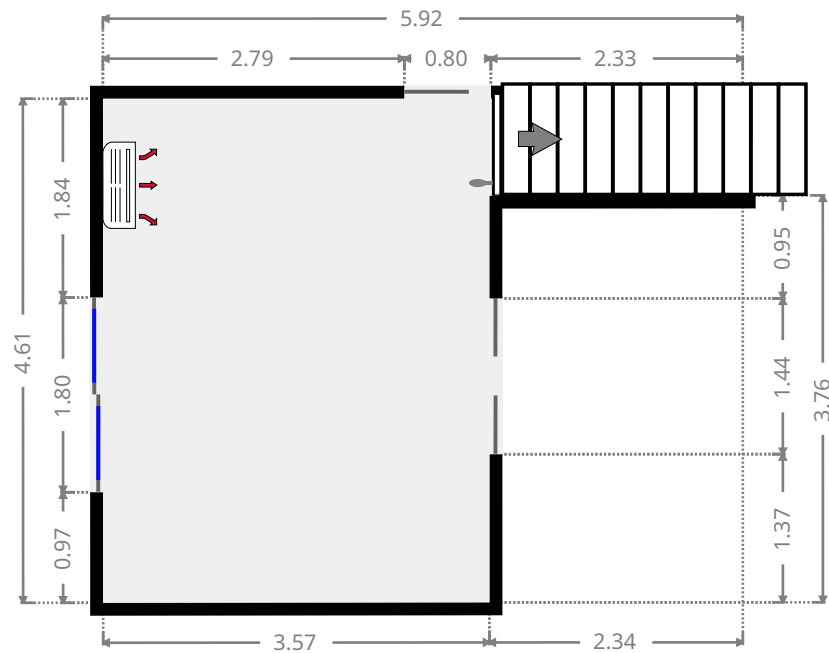
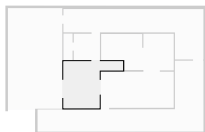

FLOORS:2

▼ **Laundry Room**
Ground Floor

WIDTH: 2.60 m • LENGTH: 2.61 m
AREA: 6.79 m² • PERIMETER: 10.43 m

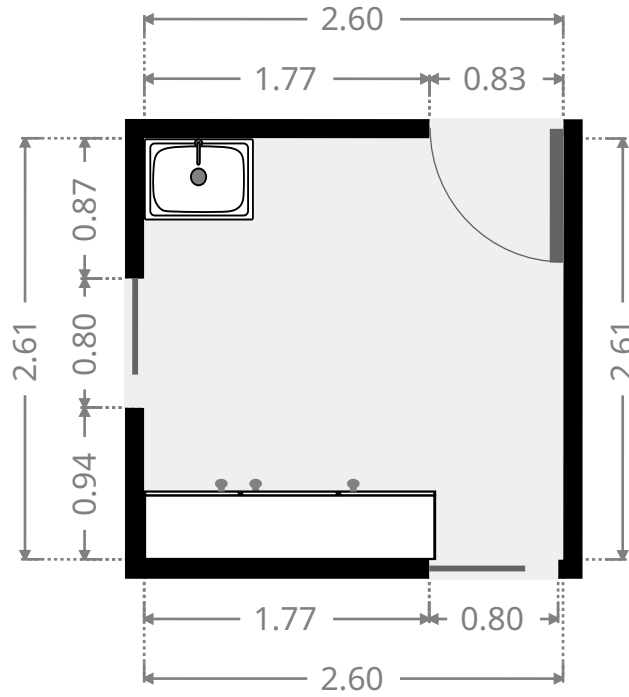
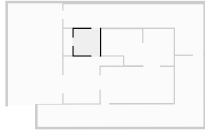

▼ **Bathroom**
Ground Floor

WIDTH: 0.90 m • LENGTH: 2.63 m
AREA: 2.37 m² • PERIMETER: 7.07 m

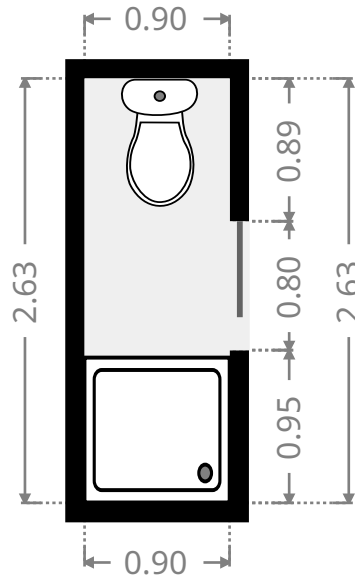
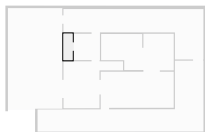

▼ Dining Room Ground Floor

WIDTH: 4.08 m • LENGTH: 3.58 m
AREA: 12.35 m² • PERIMETER: 15.32 m

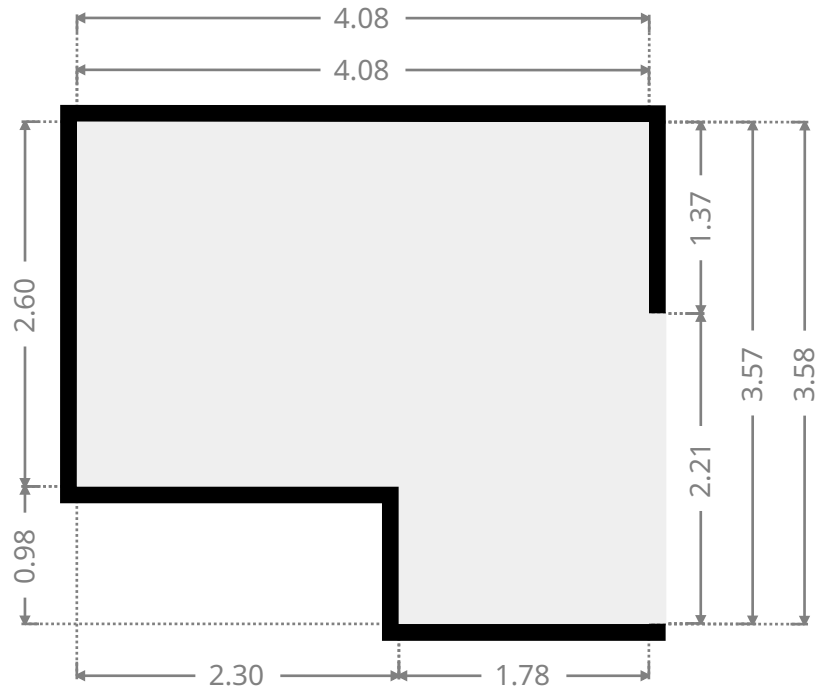
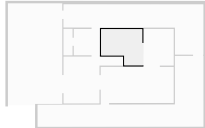

▼ Kitchen Ground Floor

WIDTH: 3.01 m • LENGTH: 3.64 m
AREA: 10.94 m² • PERIMETER: 13.29 m

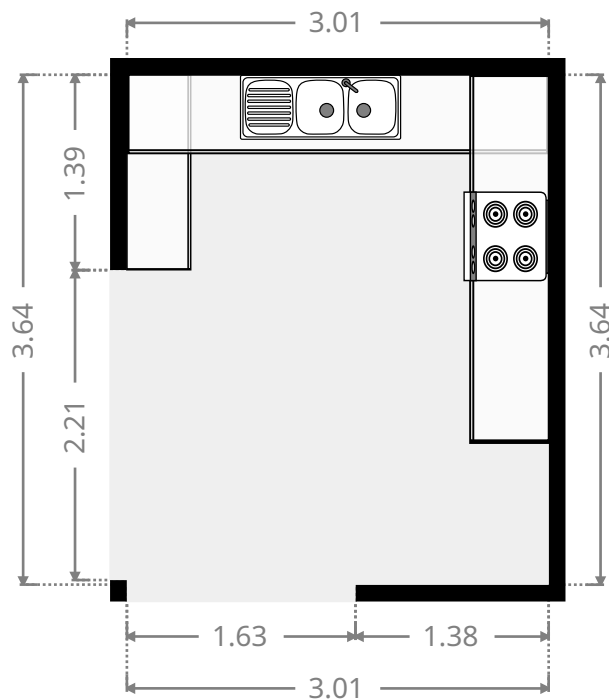
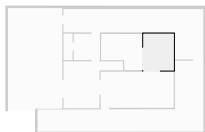

FLOORS: 2

▼ Garage Ground Floor

WIDTH: 5.40 m • LENGTH: 9.99 m
AREA: 53.95 m² • PERIMETER: 30.78 m

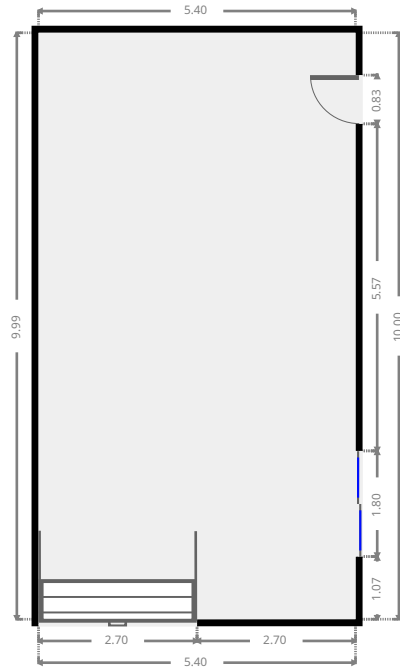
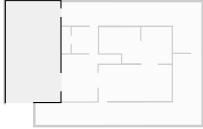

▼ . Ground Floor

WIDTH: 13.90 m • LENGTH: 5.00 m
AREA: 39.76 m² • PERIMETER: 37.80 m

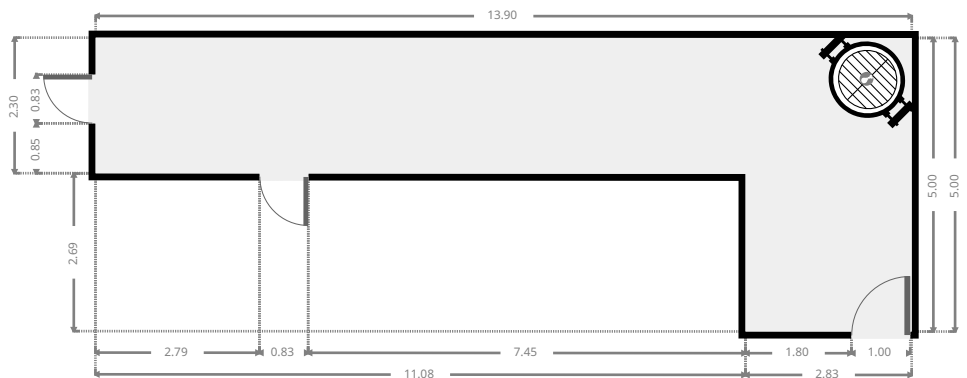
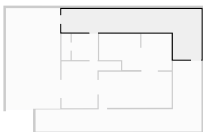

THIS FLOORPLAN IS PROVIDED WITHOUT WARRANTY OF ANY KIND. SENSOPIA DISCLAIMS ANY WARRANTY INCLUDING, WITHOUT LIMITATION, SATISFACTORY QUALITY OR ACCURACY OF DIMENSIONS.

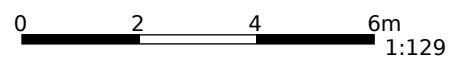

FLOORS: 2

▼ Verandah Ground Floor

WIDTH: 16.48 m • LENGTH: 7.04 m
AREA: 50.08 m² • PERIMETER: 47.02 m

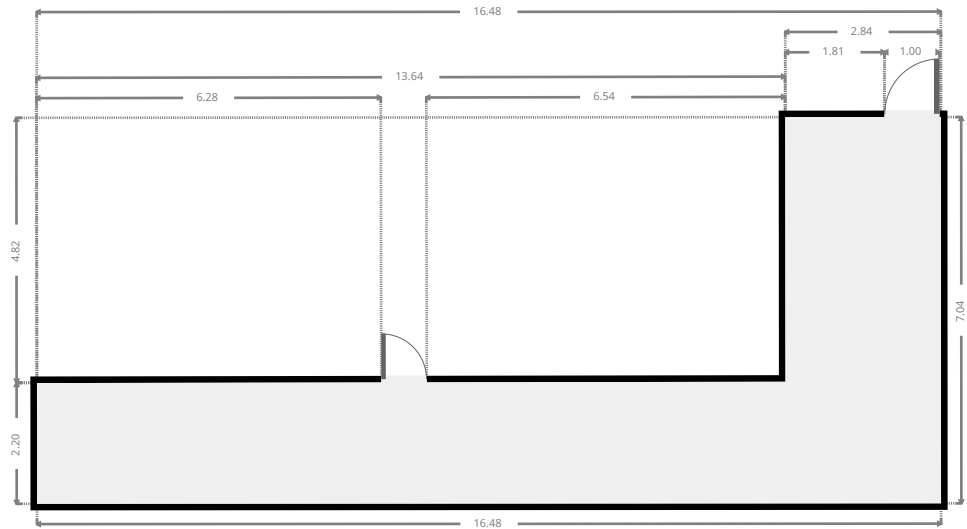
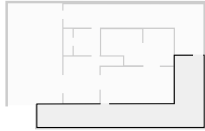

▼ Pool Area Ground Floor

WIDTH: 15.50 m • LENGTH: 10.00 m
AREA: 154.99 m² • PERIMETER: 51.00 m

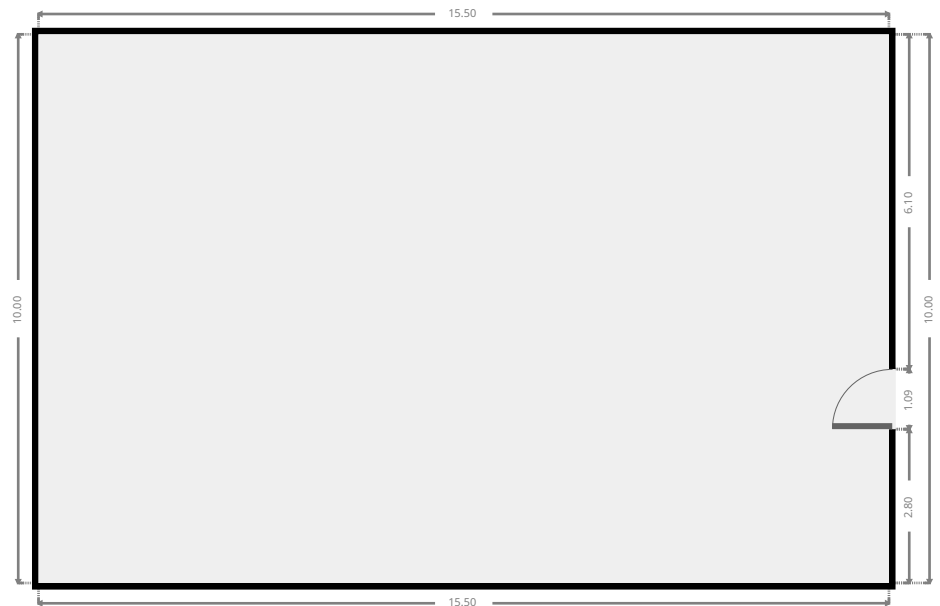
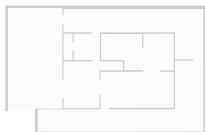

THIS FLOORPLAN IS PROVIDED WITHOUT WARRANTY OF ANY KIND. SENSOPIA DISCLAIMS ANY WARRANTY INCLUDING, WITHOUT LIMITATION, SATISFACTORY QUALITY OR ACCURACY OF DIMENSIONS.

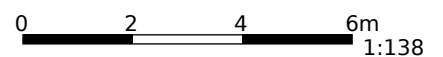

▼ 1st Floor

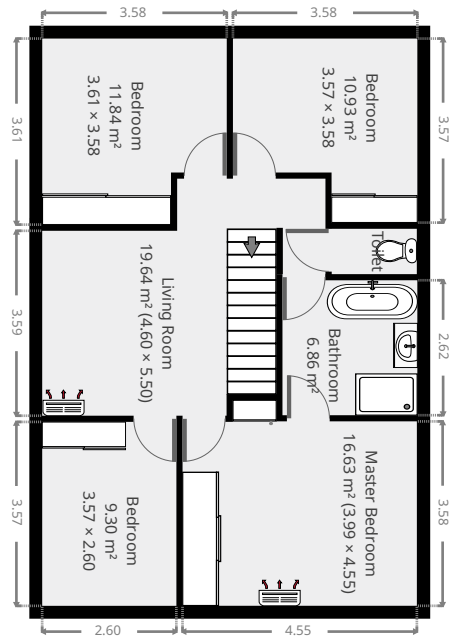

▼ Living Room
1st Floor

WIDTH: 4.60 m • LENGTH: 5.50 m
AREA: 19.64 m² • PERIMETER: 20.20 m

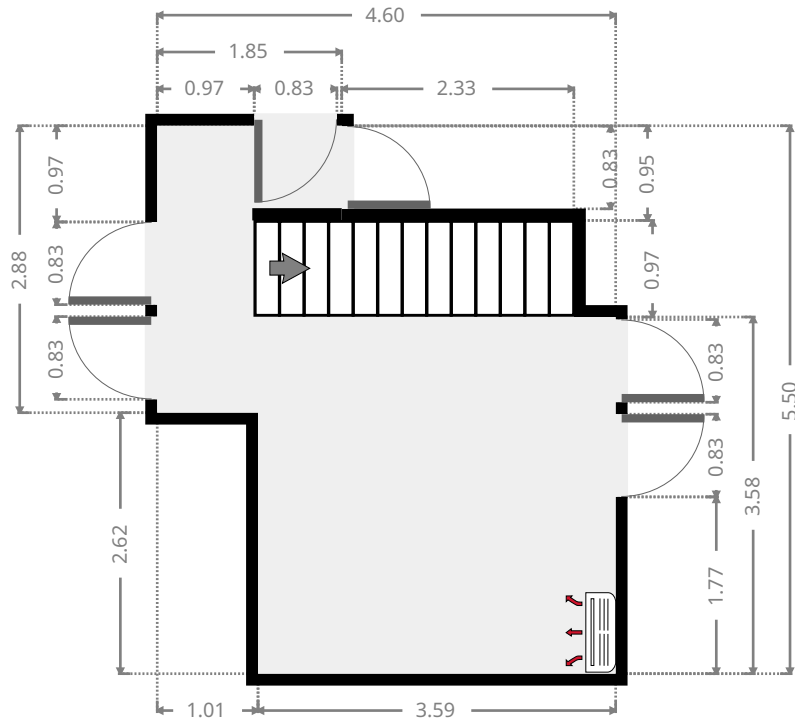
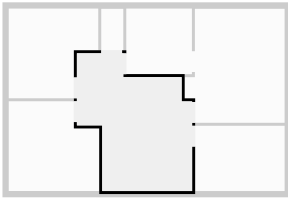

▼ Master Bedroom
1st Floor

WIDTH: 3.99 m • LENGTH: 4.55 m
AREA: 16.63 m² • PERIMETER: 17.08 m

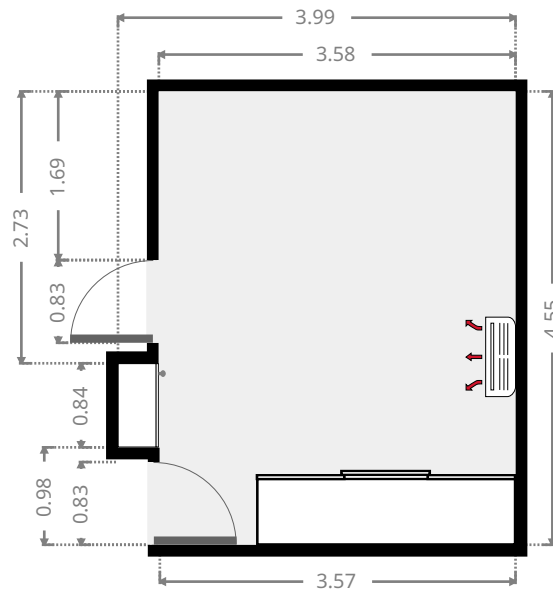
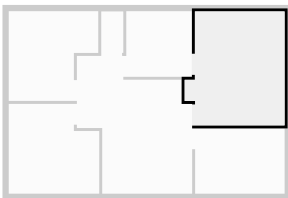

FLOORS: 2

▼ **Bathroom**
1st Floor

WIDTH: 2.62 m • LENGTH: 2.62 m
AREA: 6.86 m² • PERIMETER: 10.48 m

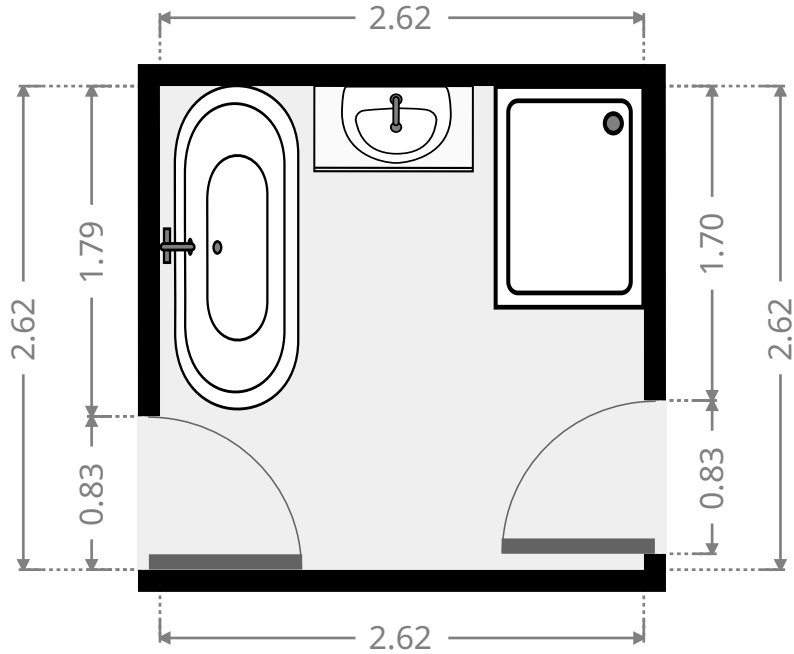
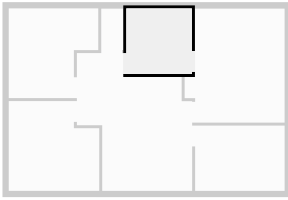

▼ **Toilet**
1st Floor

WIDTH: 0.88 m • LENGTH: 1.65 m
AREA: 1.45 m² • PERIMETER: 5.06 m

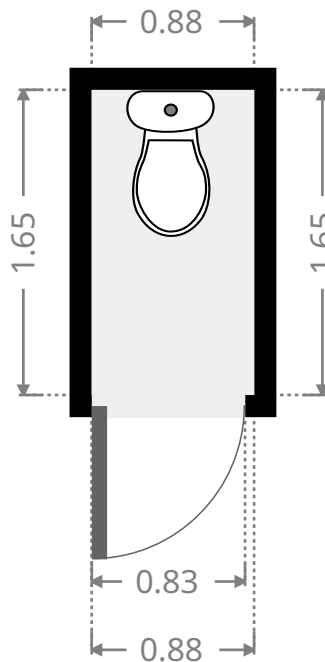
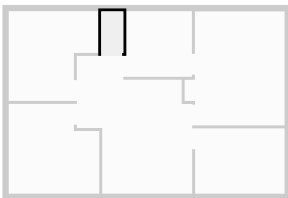

FLOORS: 2

▼ **Bedroom**
1st Floor

WIDTH: 3.57 m • LENGTH: 3.58 m
AREA: 10.93 m² • PERIMETER: 14.31 m

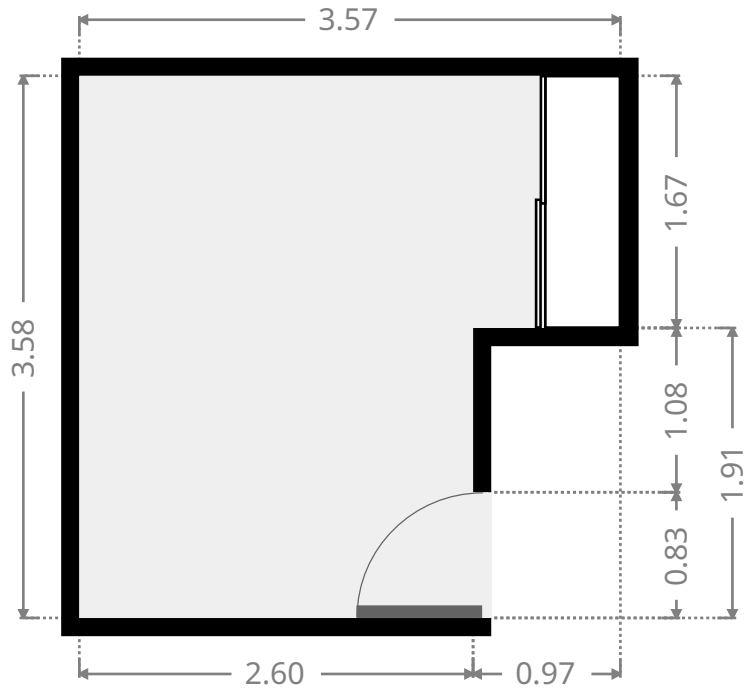
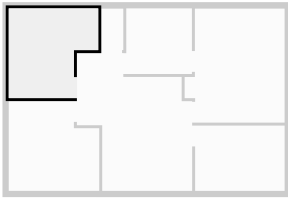

▼ **Bedroom**
1st Floor

WIDTH: 3.61 m • LENGTH: 3.58 m
AREA: 11.84 m² • PERIMETER: 14.39 m

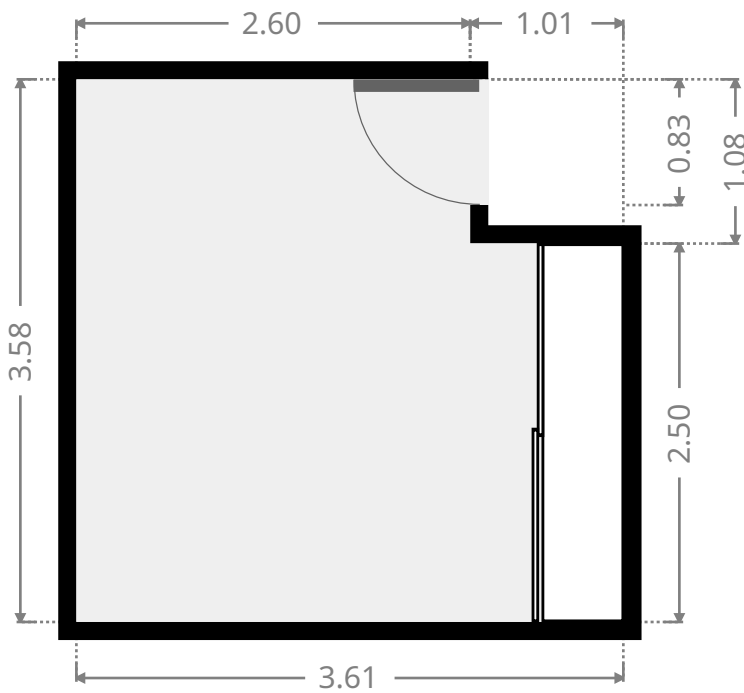
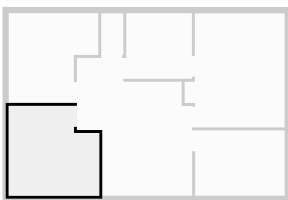

▼ **Bedroom**
1st Floor

WIDTH: 3.57 m • LENGTH: 2.60 m
AREA: 9.30 m² • PERIMETER: 12.35 m

