

164 Gair Street

Created on
2021-05-11

Floors
1

▼ Ground Floor

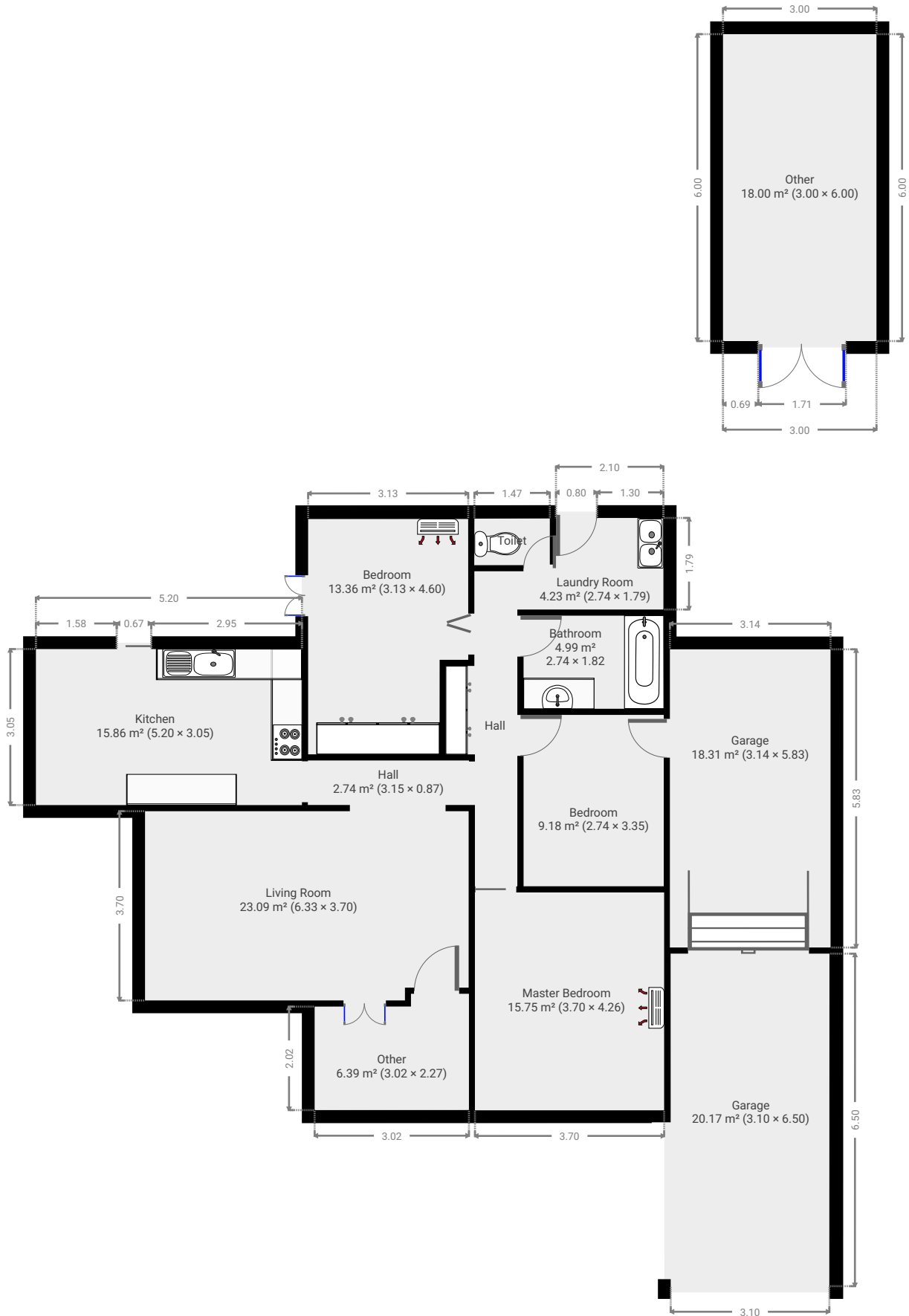

▼ Living Room
Ground Floor

WIDTH: 6.33 m • LENGTH: 3.70 m
AREA: 23.09 m² • PERIMETER: 20.05 m

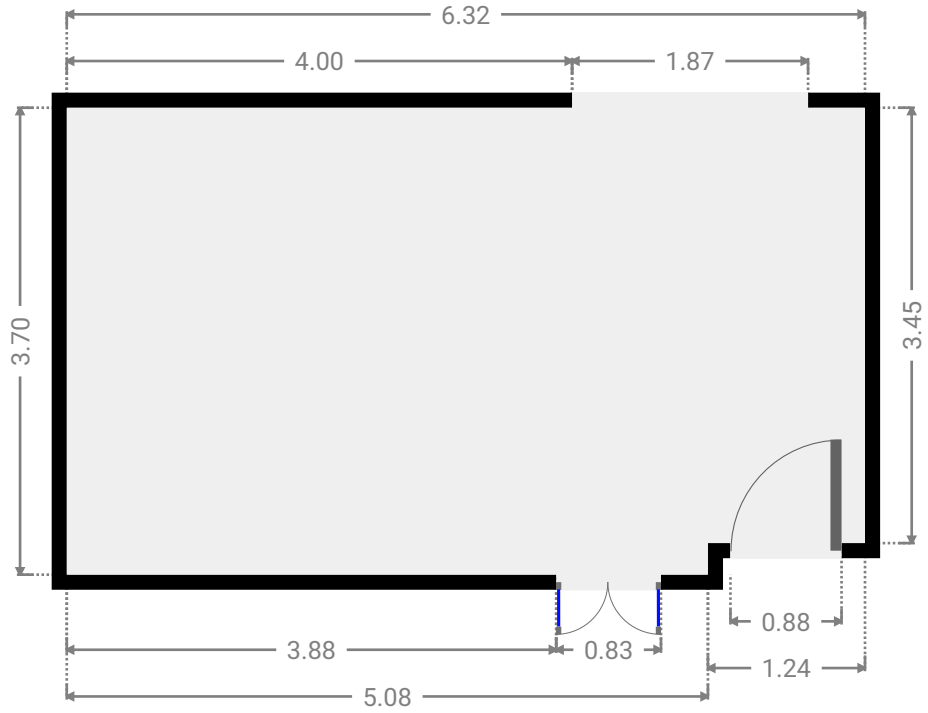
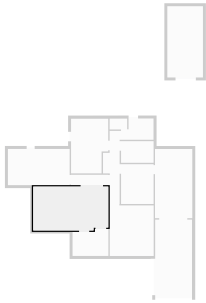

▼ Hall
Ground Floor

WIDTH: 3.15 m • LENGTH: 0.87 m
AREA: 2.74 m² • PERIMETER: 8.04 m

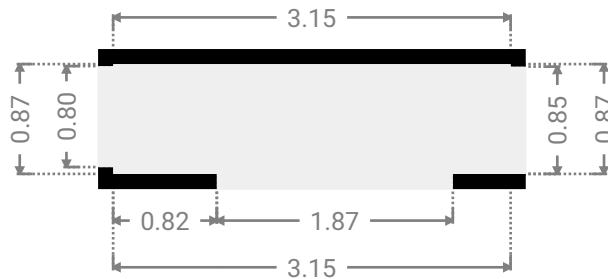
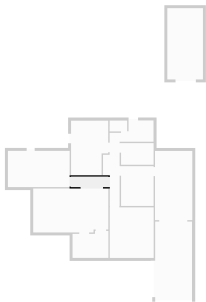

▼ **Kitchen**
Ground Floor

WIDTH: 5.20 m • LENGTH: 3.05 m
AREA: 15.86 m² • PERIMETER: 16.50 m

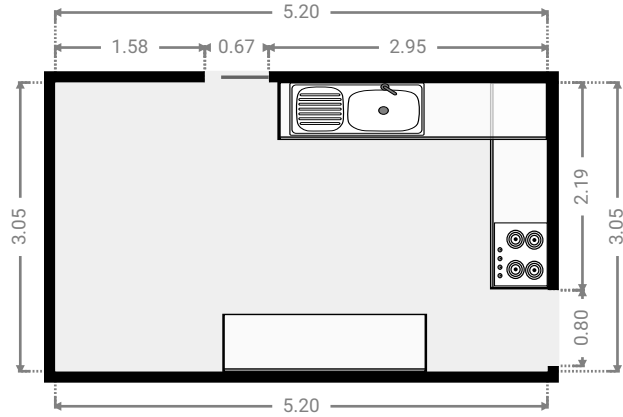
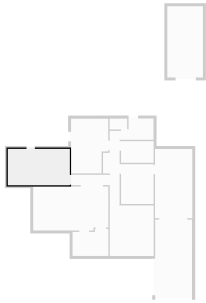

▼ **Hall**
Ground Floor

WIDTH: 1.40 m • LENGTH: 6.16 m
AREA: 6.11 m² • PERIMETER: 15.12 m

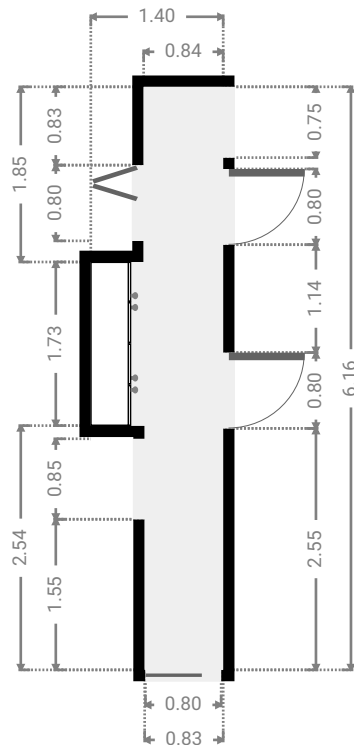
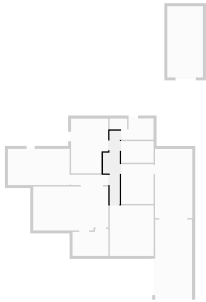

▼ **Master Bedroom**
Ground Floor

WIDTH: 3.70 m • LENGTH: 4.26 m
AREA: 15.75 m² • PERIMETER: 15.92 m

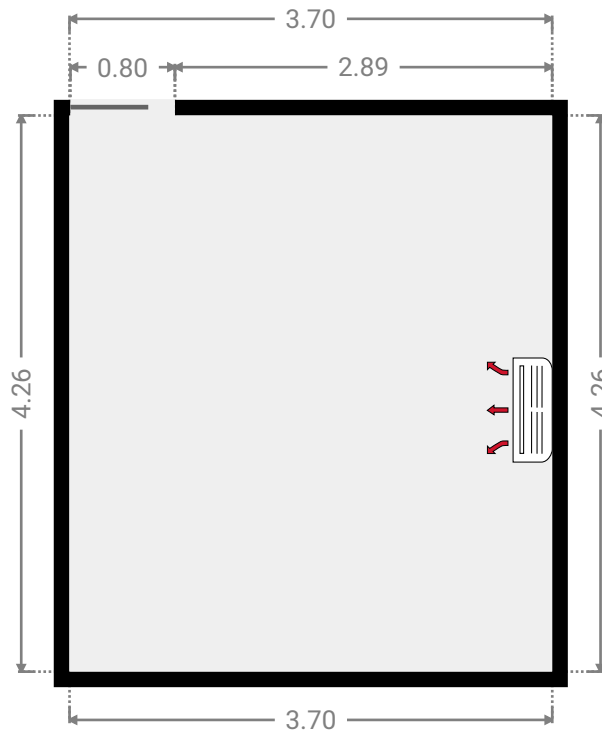
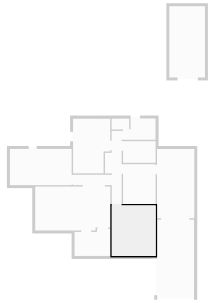

▼ **Bedroom**
Ground Floor

WIDTH: 2.74 m • LENGTH: 3.35 m
AREA: 9.18 m² • PERIMETER: 12.18 m

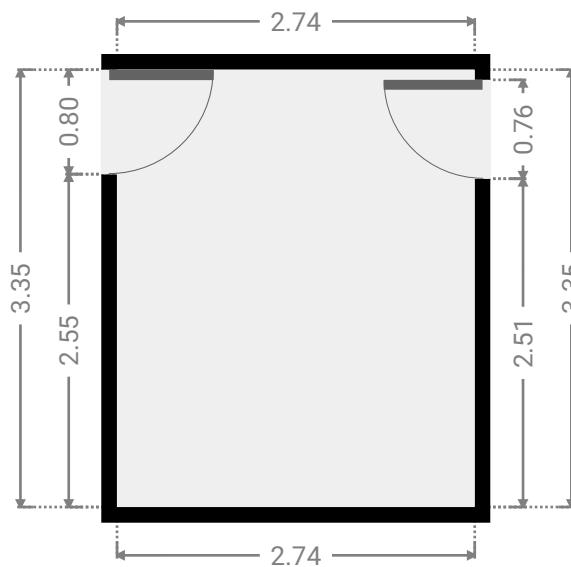
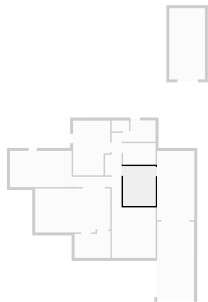

▼ **Garage**
Ground Floor

WIDTH: 3.14 m • LENGTH: 5.83 m
AREA: 18.31 m² • PERIMETER: 17.94 m

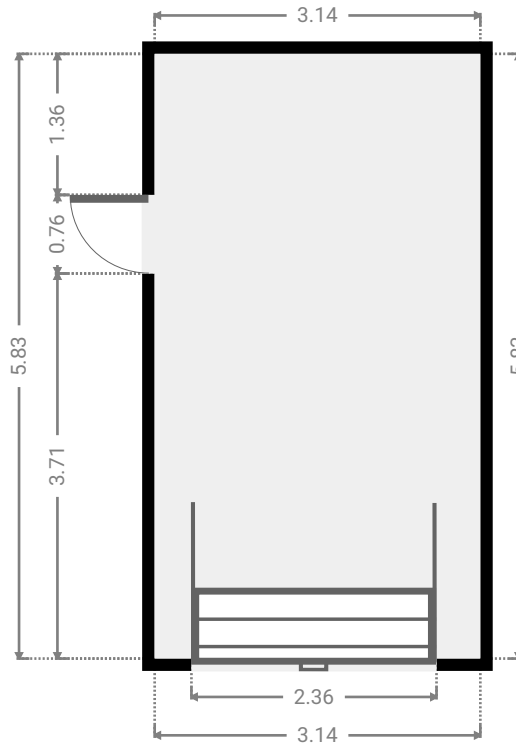
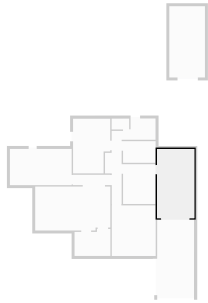

▼ **Bathroom**
Ground Floor

WIDTH: 2.74 m • LENGTH: 1.82 m
AREA: 4.99 m² • PERIMETER: 9.12 m

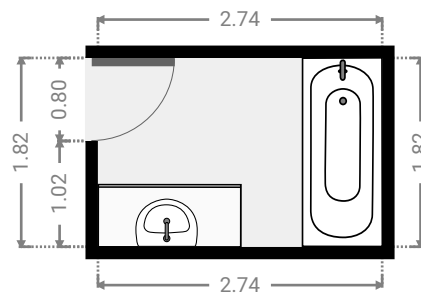
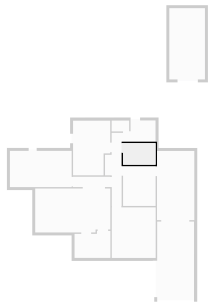

▼ **Laundry Room**
Ground Floor

WIDTH: 2.74 m • LENGTH: 1.79 m
AREA: 4.23 m² • PERIMETER: 9.05 m

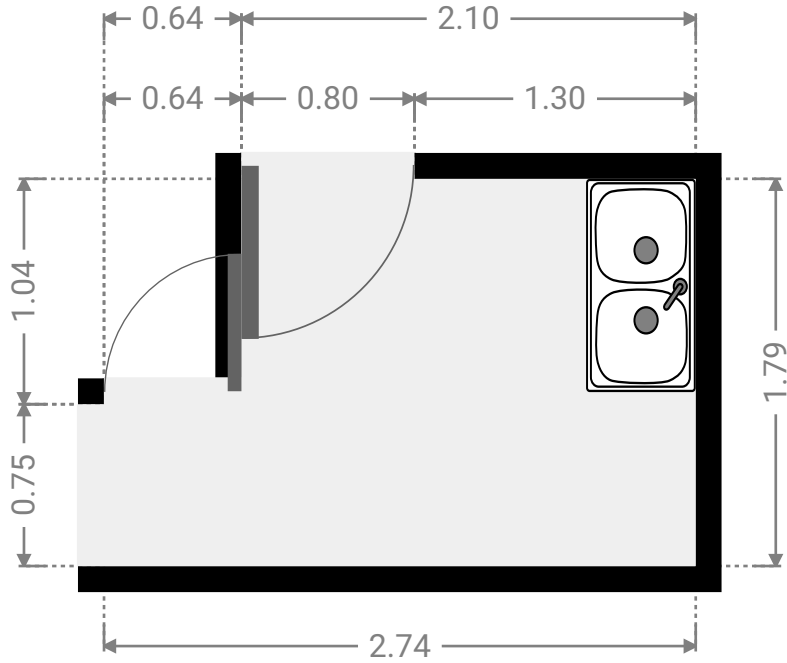
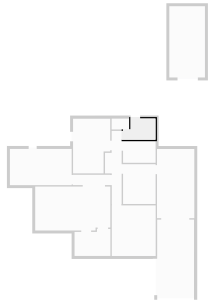

▼ **Toilet**
Ground Floor

WIDTH: 1.48 m • LENGTH: 0.91 m
AREA: 1.34 m² • PERIMETER: 4.77 m

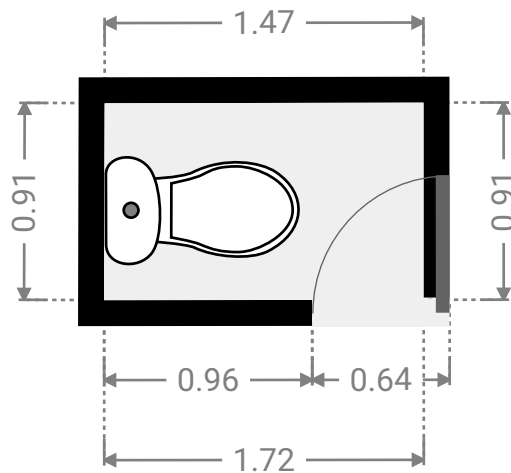
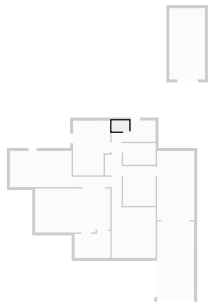

▼ **Bedroom**
Ground Floor

WIDTH: 3.13 m • LENGTH: 4.60 m
AREA: 13.36 m² • PERIMETER: 15.46 m

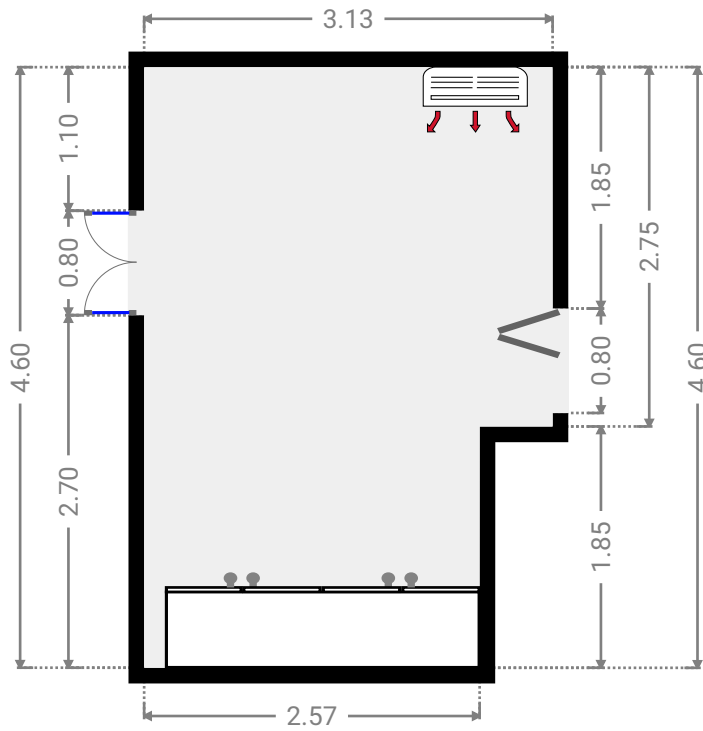
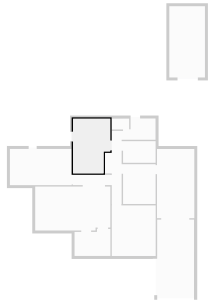

▼ **Other**
Ground Floor

WIDTH: 3.02 m • LENGTH: 2.27 m
AREA: 6.39 m² • PERIMETER: 10.58 m

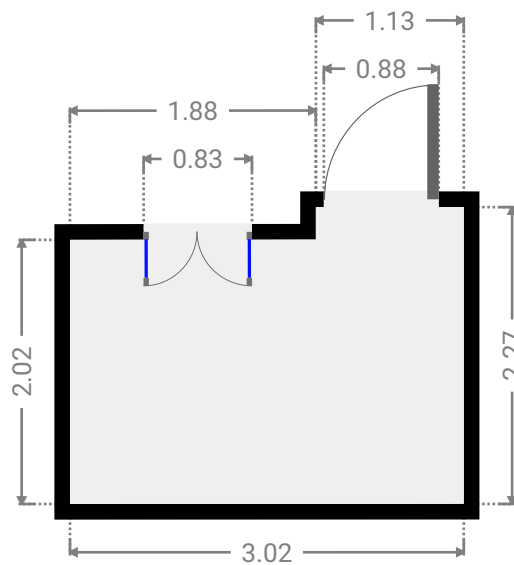
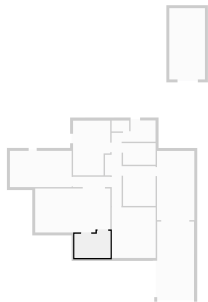

▼ Other
Ground Floor

WIDTH: 3.00 m • LENGTH: 6.00 m
AREA: 18.00 m² • PERIMETER: 18.00 m

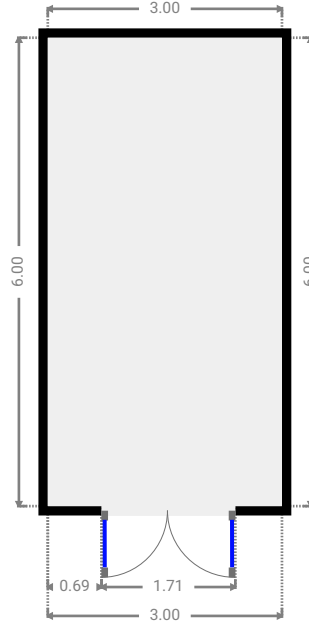
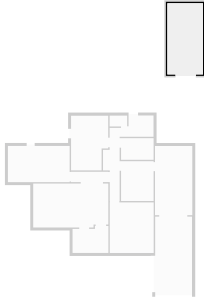

▼ Garage
Ground Floor

WIDTH: 3.10 m • LENGTH: 6.50 m
AREA: 20.17 m² • PERIMETER: 19.20 m

