

162 Talbot Street

Ground Floor

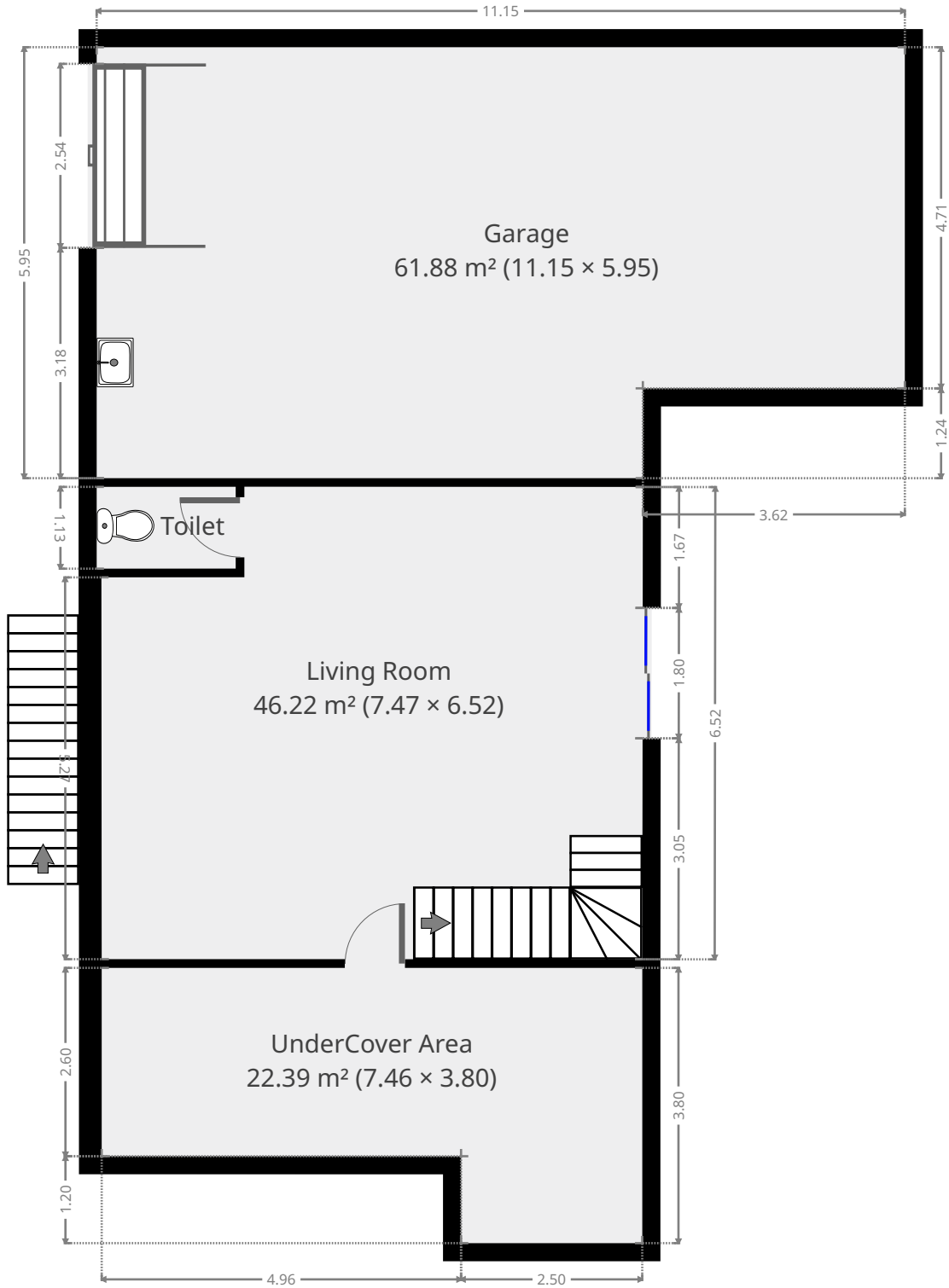

THIS FLOORPLAN IS PROVIDED WITHOUT WARRANTY OF ANY KIND. SENSOPIA DISCLAIMS ANY WARRANTY INCLUDING, WITHOUT LIMITATION, SATISFACTORY QUALITY OR ACCURACY OF DIMENSIONS.



162 Talbot Street

Living Room

Width: 6.52 m
 Length: 7.47 m
 Area: 46.22 m²
 Perimeter: 27.97 m

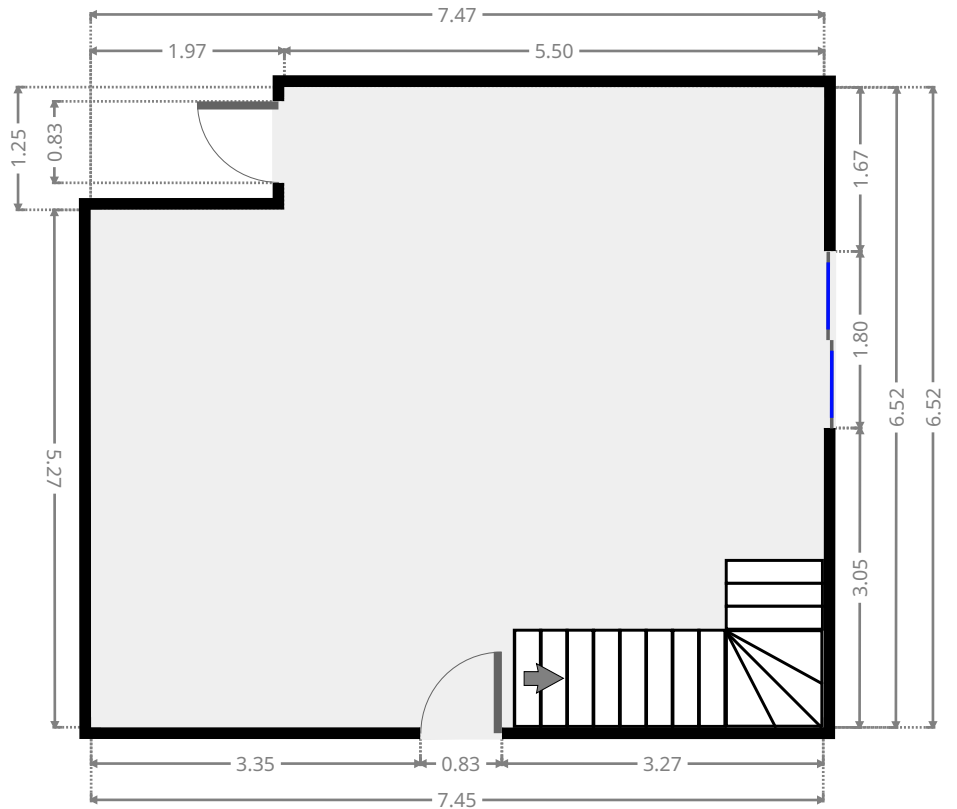
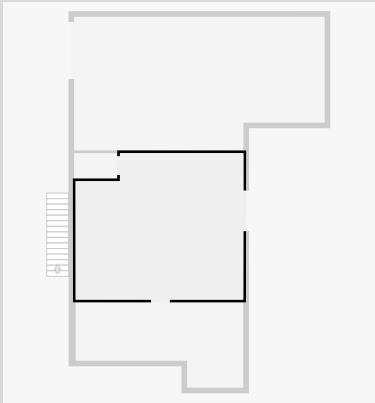

Toilet / Half Bath

Width: 1.13 m
 Length: 1.92 m
 Area: 2.17 m²
 Perimeter: 6.09 m

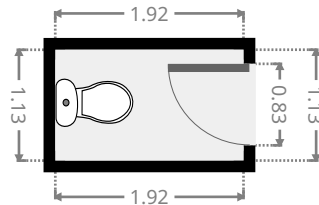
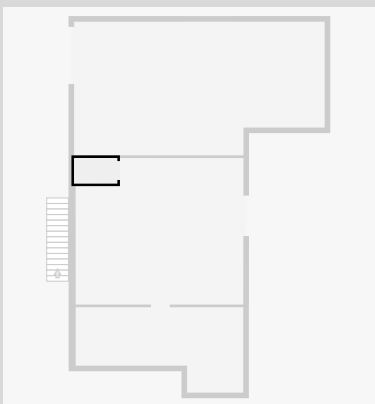

162 Talbot Street

Garage

Width: 5.95 m
Length: 11.15 m
Area: 61.88 m²
Perimeter: 34.21 m

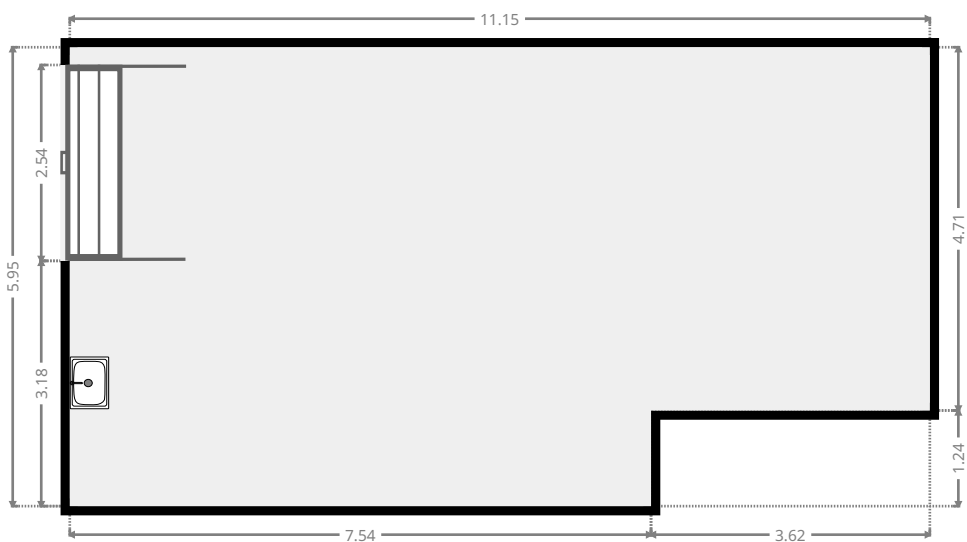
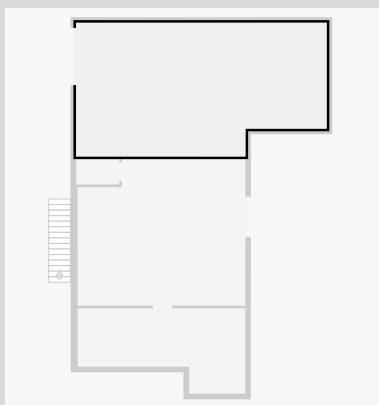

THIS FLOORPLAN IS PROVIDED WITHOUT WARRANTY OF ANY KIND. SENSOPIA DISCLAIMS ANY WARRANTY INCLUDING, WITHOUT LIMITATION, SATISFACTORY QUALITY OR ACCURACY OF DIMENSIONS.



162 Talbot Street

UnderCover Area

Width:	3.80 m
Length:	7.46 m
Area	22.39 m ²
Perimeter	22.52 m

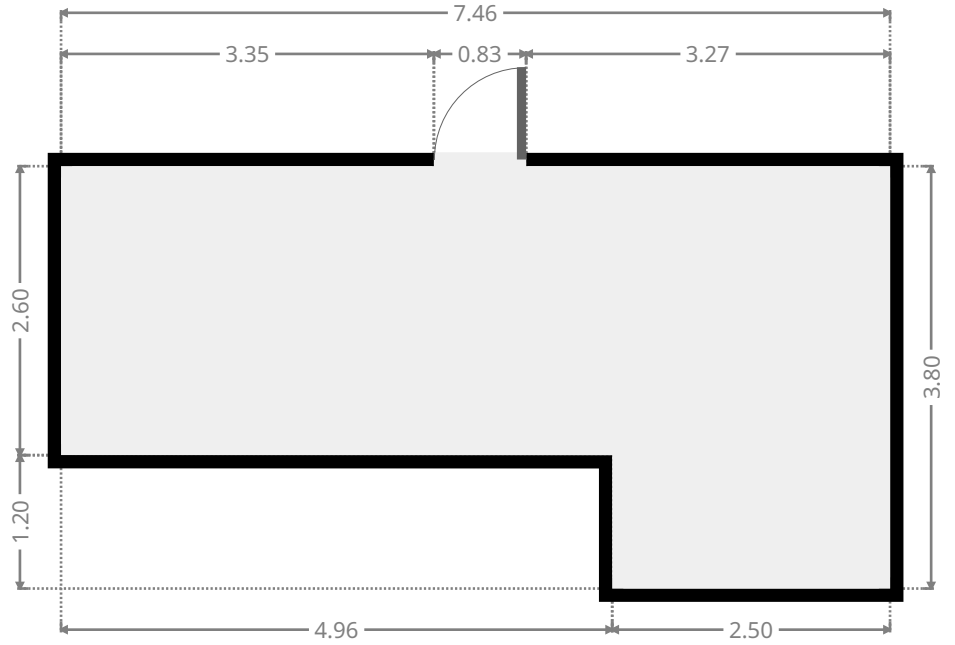
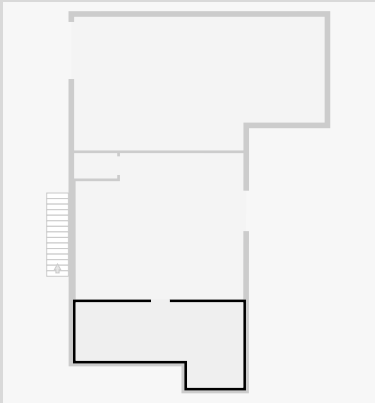

162 Talbot Street

1st Floor

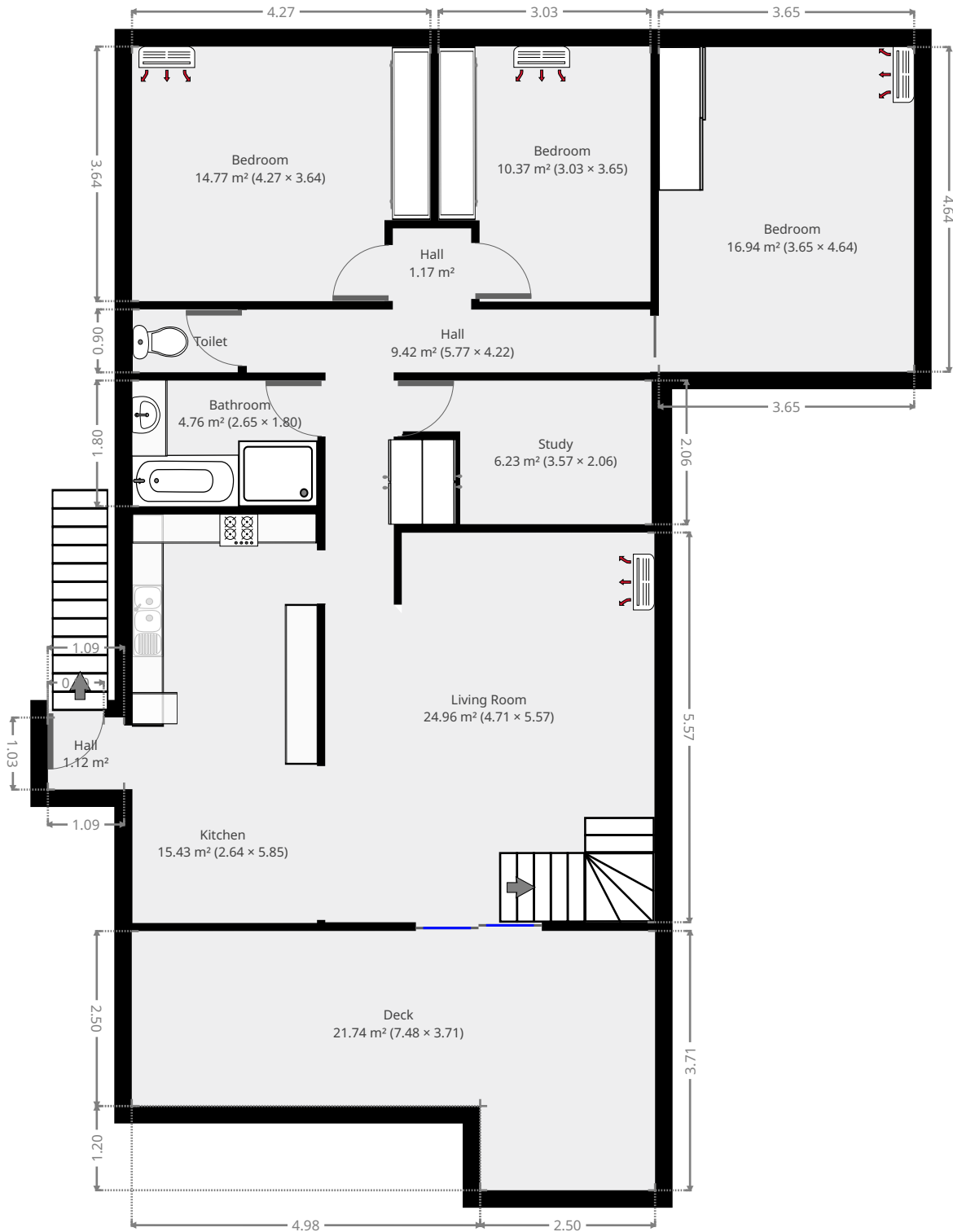

THIS FLOORPLAN IS PROVIDED WITHOUT WARRANTY OF ANY KIND. SENSOPIA DISCLAIMS ANY WARRANTY INCLUDING, WITHOUT LIMITATION, SATISFACTORY QUALITY OR ACCURACY OF DIMENSIONS.

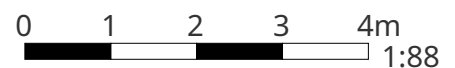

162 Talbot Street

Kitchen

Width: 2.64 m
Length: 5.85 m
Area: 15.43 m²
Perimeter: 16.97 m

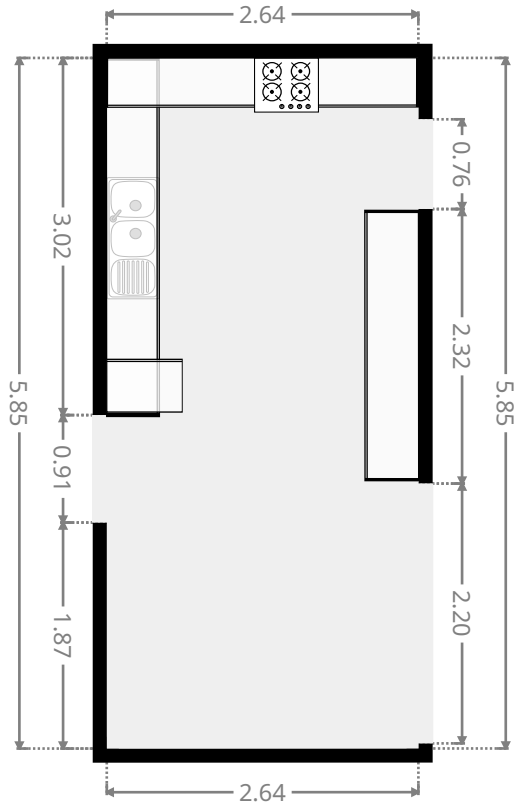
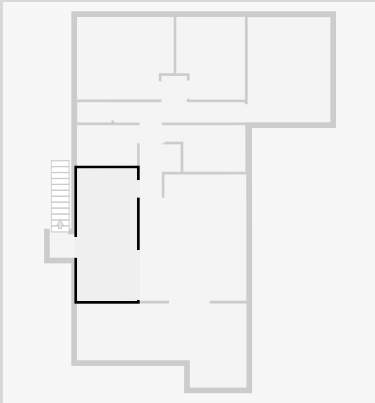

Hall

Width: 1.03 m
Length: 1.09 m
Area: 1.12 m²
Perimeter: 4.24 m

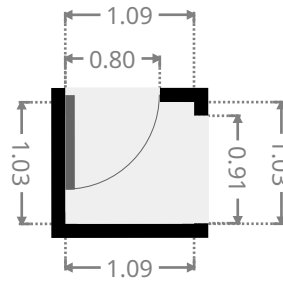
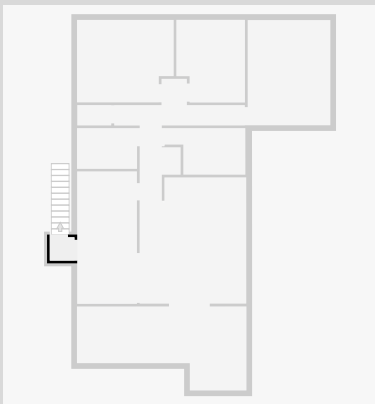

162 Talbot Street

Living Room

Width: 4.71 m
 Length: 5.57 m
 Area: 24.96 m²
 Perimeter: 20.56 m

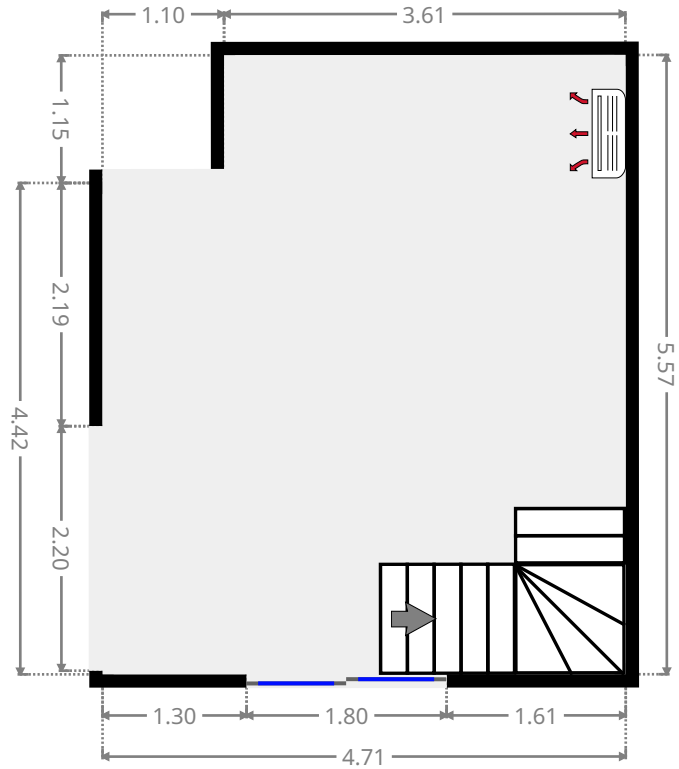
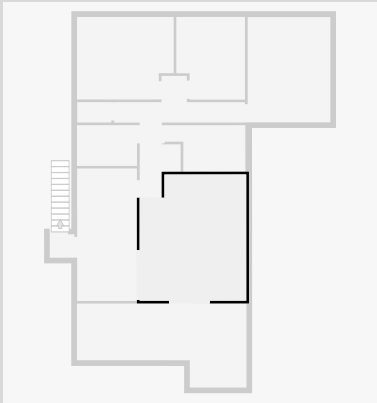

Hall

Width: 4.22 m
 Length: 5.77 m
 Area: 9.42 m²
 Perimeter: 21.63 m

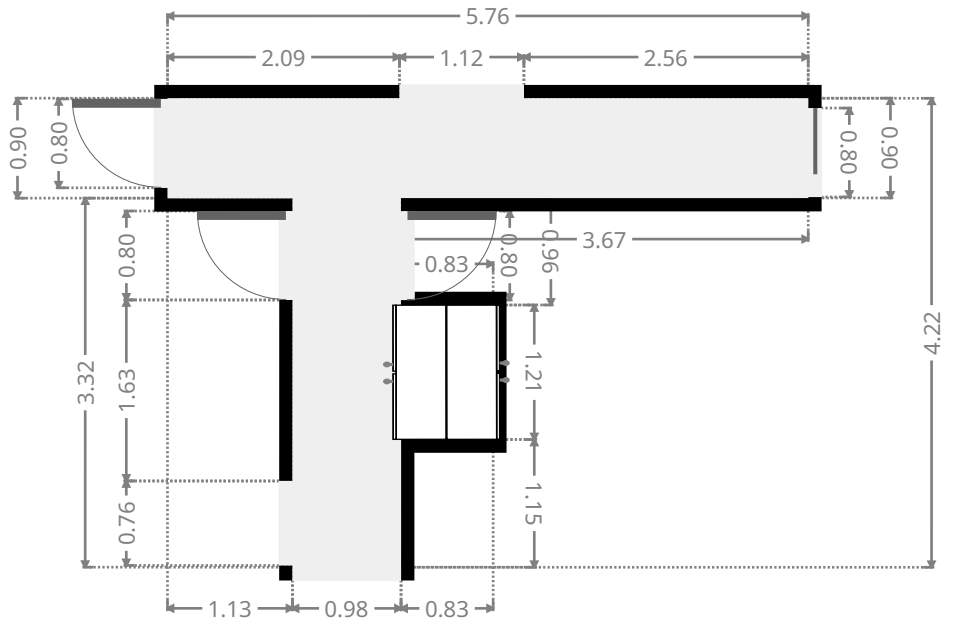
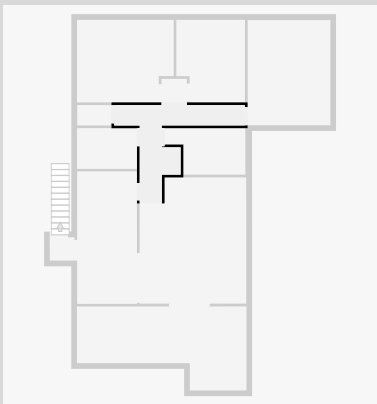

THIS FLOORPLAN IS PROVIDED WITHOUT WARRANTY OF ANY KIND. SENSOPIA DISCLAIMS ANY WARRANTY INCLUDING, WITHOUT LIMITATION, SATISFACTORY QUALITY OR ACCURACY OF DIMENSIONS.

162 Talbot Street

Bathroom

Width: 1.80 m
Length: 2.65 m
Area: 4.76 m²
Perimeter: 8.89 m

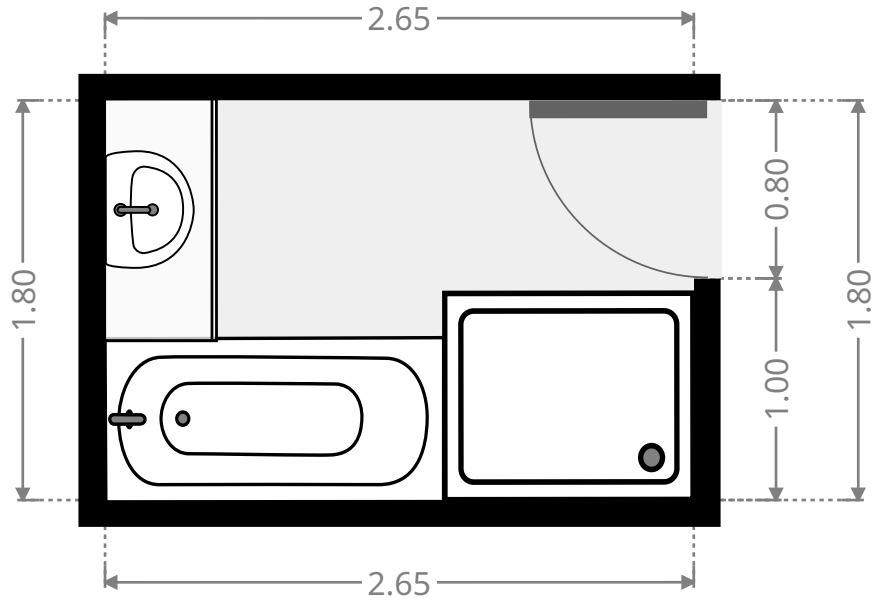
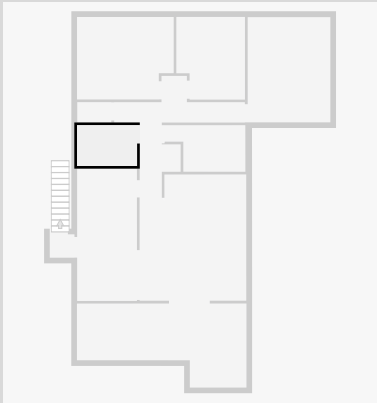

Toilet / Half Bath

Width: 0.90 m
Length: 1.50 m
Area: 1.35 m²
Perimeter: 4.80 m

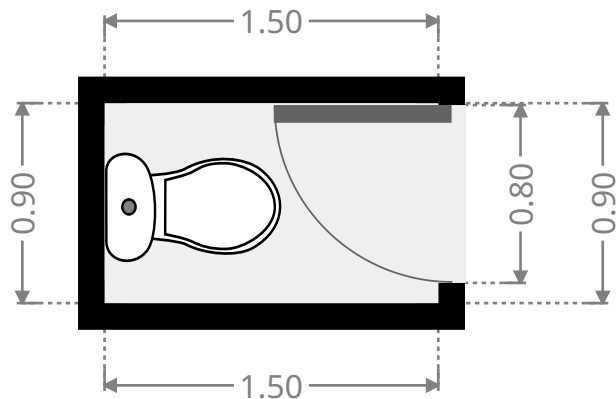
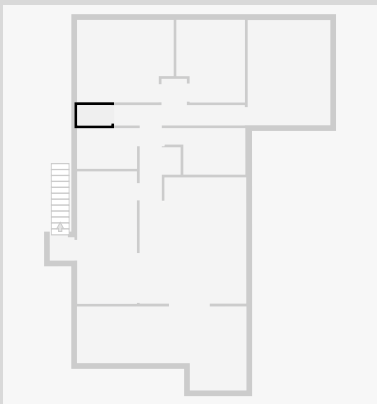

162 Talbot Street

Study

Width: 2.06 m
Length: 3.57 m
Area: 6.23 m²
Perimeter: 11.25 m

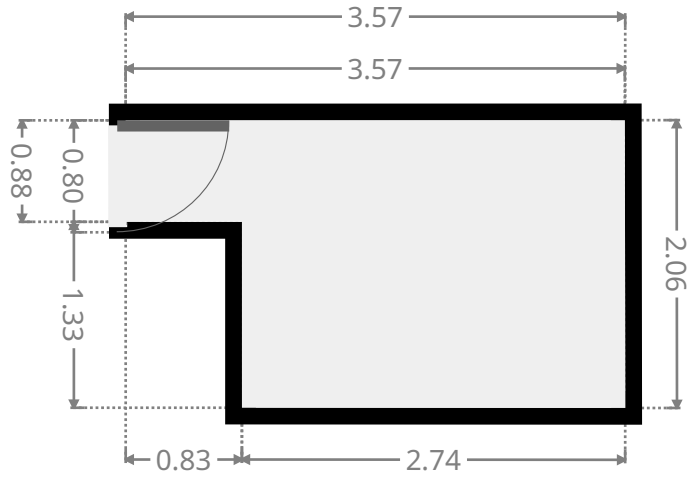
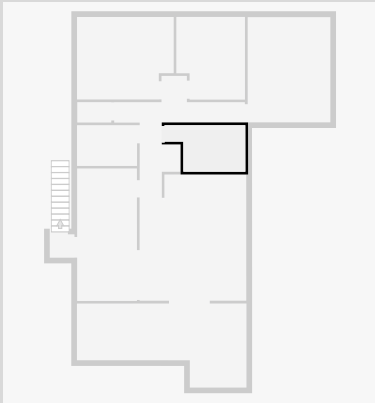

Bedroom

Width: 3.65 m
Length: 4.64 m
Area: 16.94 m²
Perimeter: 16.58 m

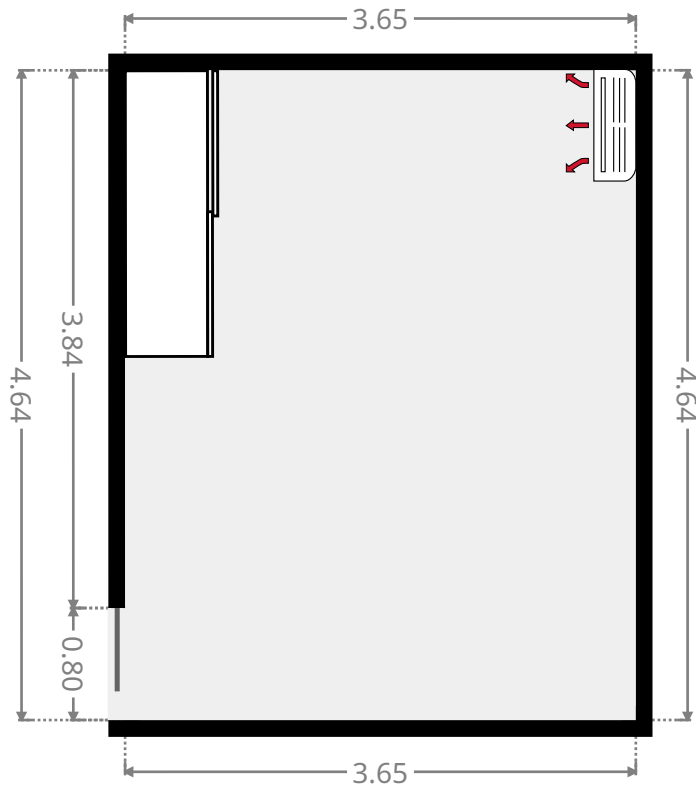
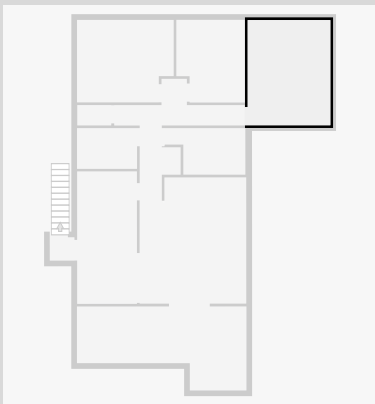

162 Talbot Street

Bedroom

Width: 3.03 m
 Length: 3.65 m
 Area: 10.37 m²
 Perimeter: 13.36 m

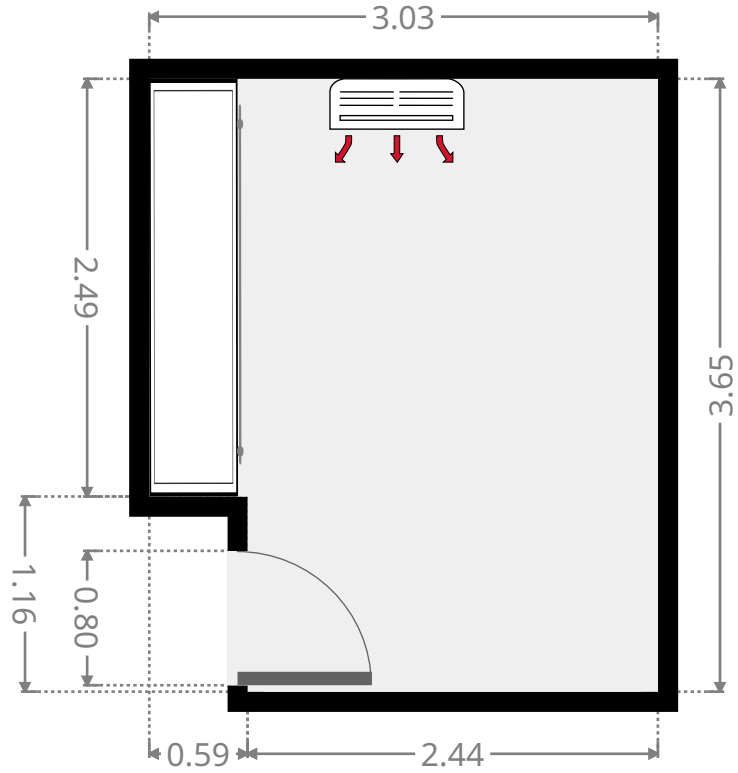
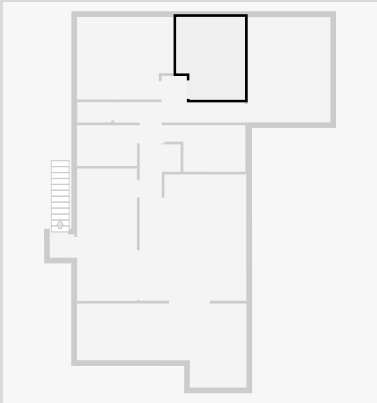

Hall

Width: 1.05 m
 Length: 1.12 m
 Area: 1.17 m²
 Perimeter: 4.34 m

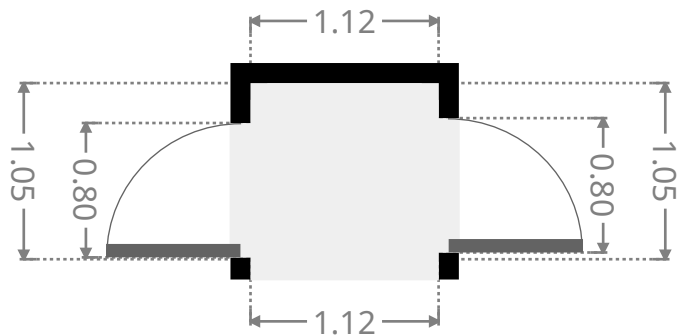
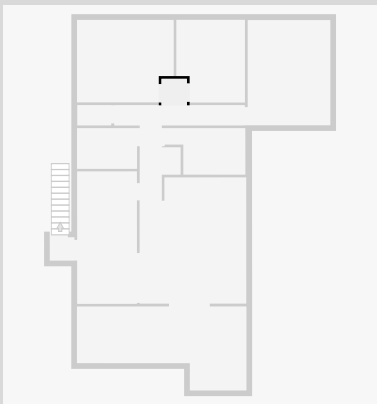

162 Talbot Street

Bedroom

Width: 3.64 m
Length: 4.27 m
Area: 14.77 m²
Perimeter: 15.81 m

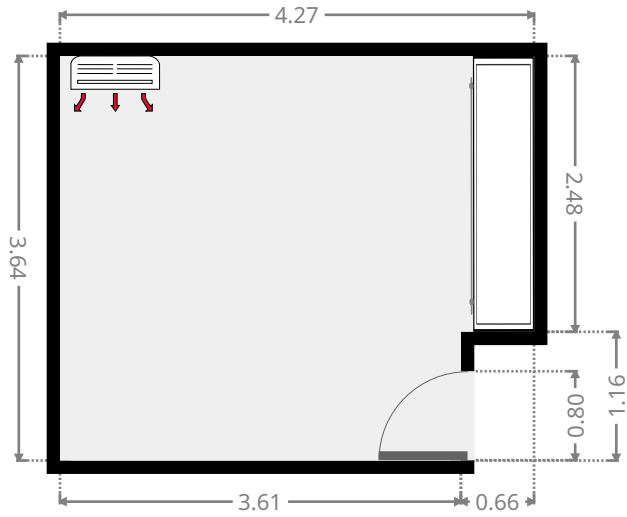
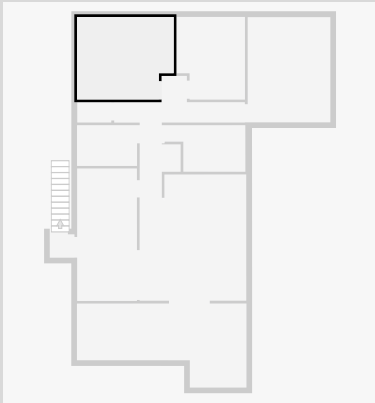

Deck

Width: 3.71 m
Length: 7.48 m
Area: 21.74 m²
Perimeter: 22.38 m

