

160 Newell's Road

Ground Floor

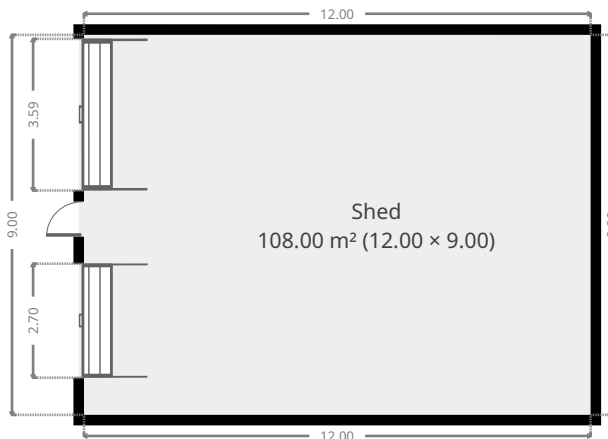

THIS FLOORPLAN IS PROVIDED WITHOUT WARRANTY OF ANY KIND. SENSOPIA DISCLAIMS ANY WARRANTY INCLUDING, WITHOUT LIMITATION, SATISFACTORY QUALITY OR ACCURACY OF DIMENSIONS.

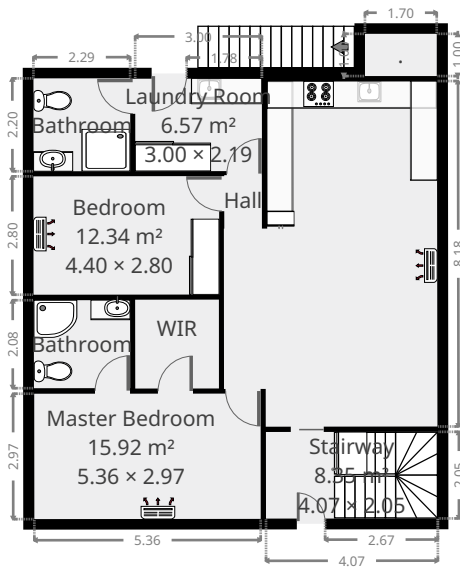
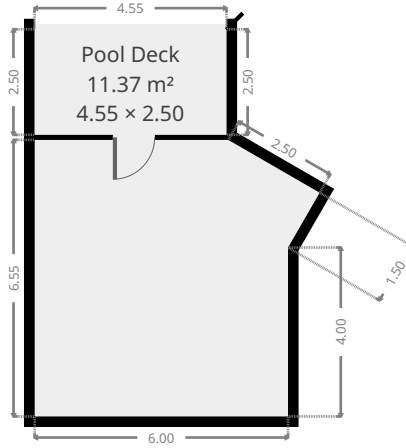

160 Newell's Road

Stairway

Width:	2.05 m
Length:	4.07 m
Area	8.35 m ²
Perimeter	12.24 m

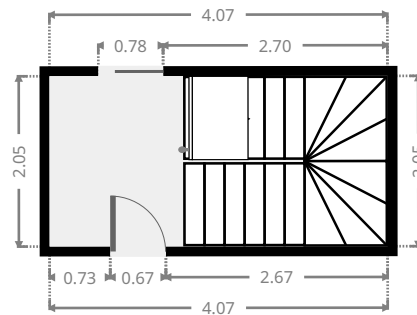
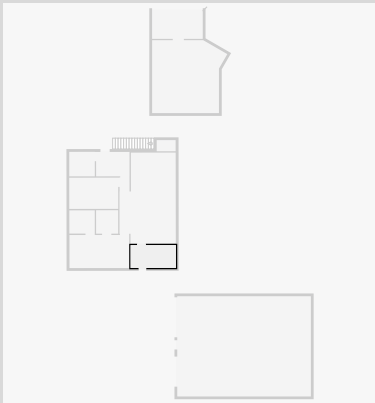

Living/Kitchen/Dining

Width:	5.05 m
Length:	8.18 m
Area	36.87 m ²
Perimeter	26.47 m

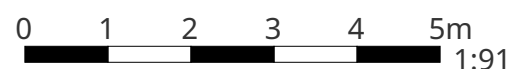
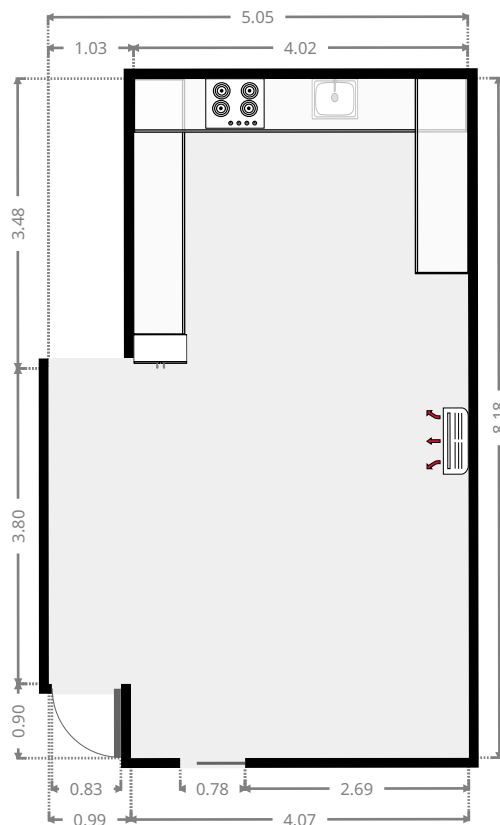
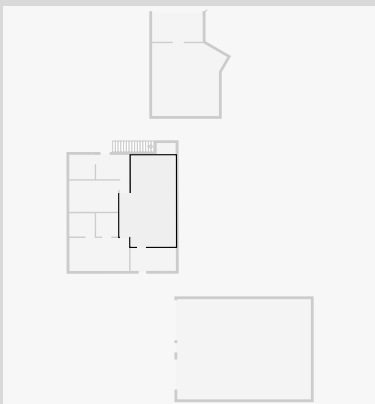

THIS FLOORPLAN IS PROVIDED WITHOUT WARRANTY OF ANY KIND. SENSOPIA DISCLAIMS ANY WARRANTY INCLUDING, WITHOUT LIMITATION, SATISFACTORY QUALITY OR ACCURACY OF DIMENSIONS.

160 Newell's Road

Hall

Width:	0.89 m
Length:	1.17 m
Area	1.04 m ²
Perimeter	4.12 m

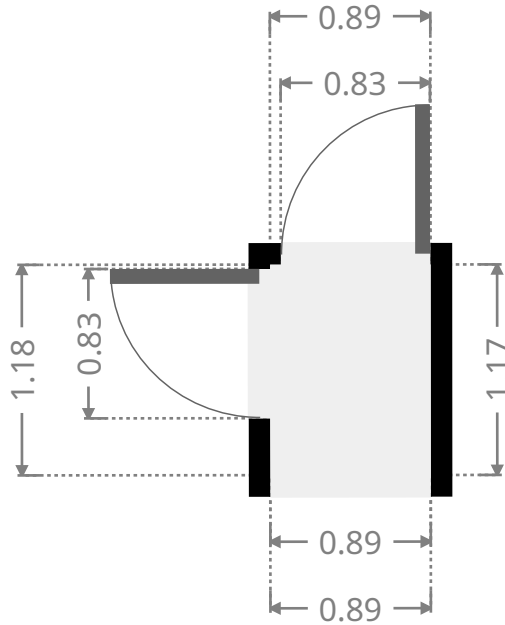
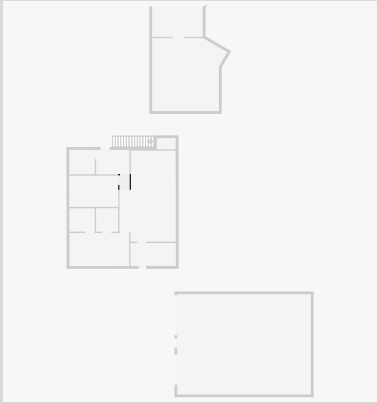

Laundry Room

Width:	2.19 m
Length:	3.00 m
Area	6.57 m ²
Perimeter	10.38 m

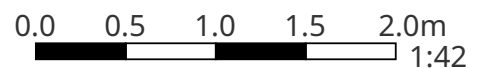
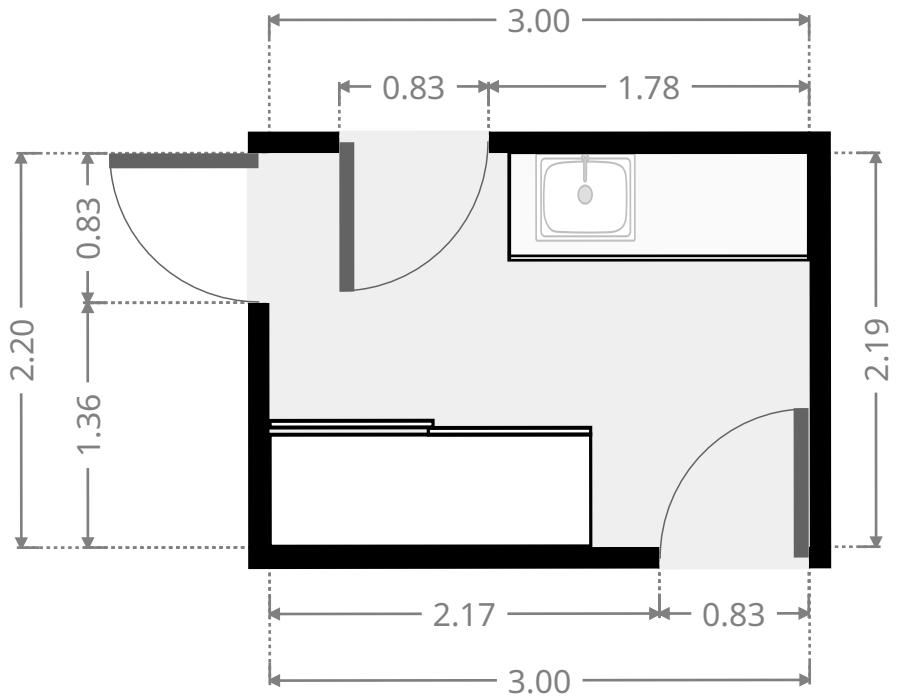
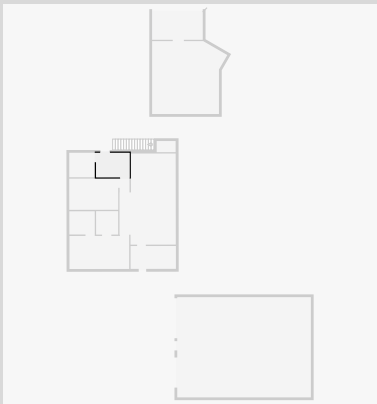

THIS FLOORPLAN IS PROVIDED WITHOUT WARRANTY OF ANY KIND. SENSOPIA DISCLAIMS ANY WARRANTY INCLUDING, WITHOUT LIMITATION, SATISFACTORY QUALITY OR ACCURACY OF DIMENSIONS.

160 Newell's Road

Bathroom

Width: 2.20 m
 Length: 2.29 m
 Area: 5.04 m²
 Perimeter: 8.98 m

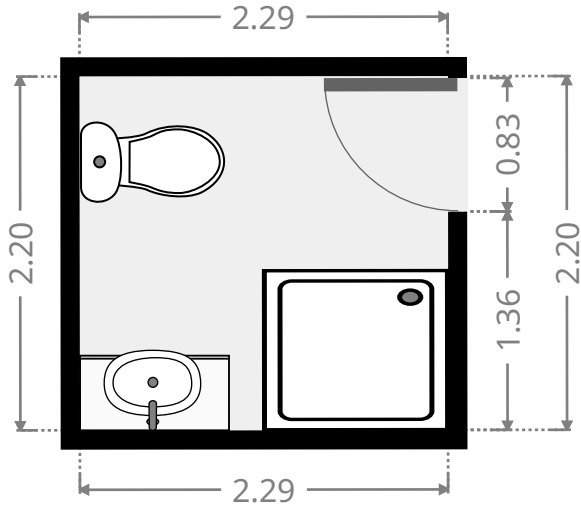
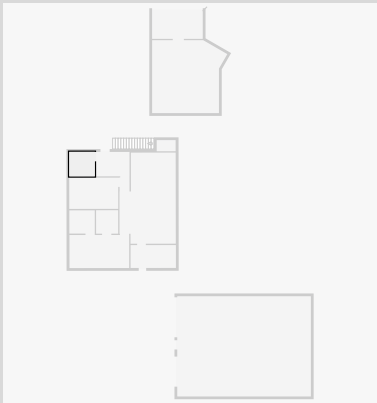

Bedroom

Width: 2.80 m
 Length: 4.40 m
 Area: 12.34 m²
 Perimeter: 14.41 m

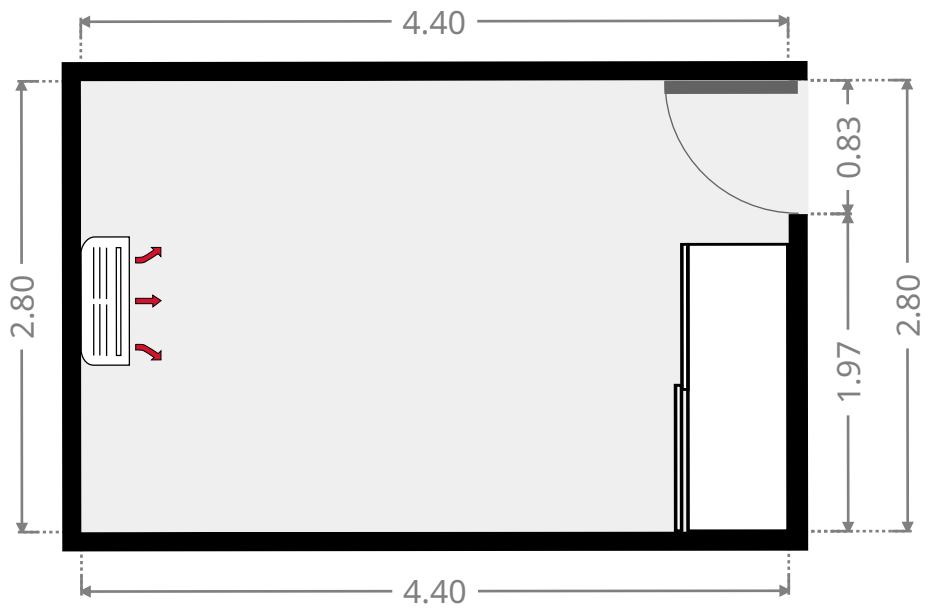
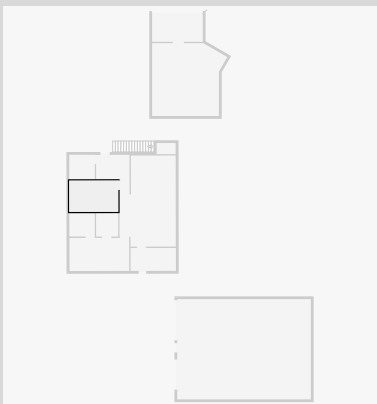

THIS FLOORPLAN IS PROVIDED WITHOUT WARRANTY OF ANY KIND. SENSOPIA DISCLAIMS ANY WARRANTY INCLUDING, WITHOUT LIMITATION, SATISFACTORY QUALITY OR ACCURACY OF DIMENSIONS.

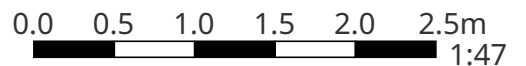

160 Newell's Road

Master Bedroom

Width: 2.97 m
 Length: 5.36 m
 Area: 15.92 m²
 Perimeter: 16.66 m

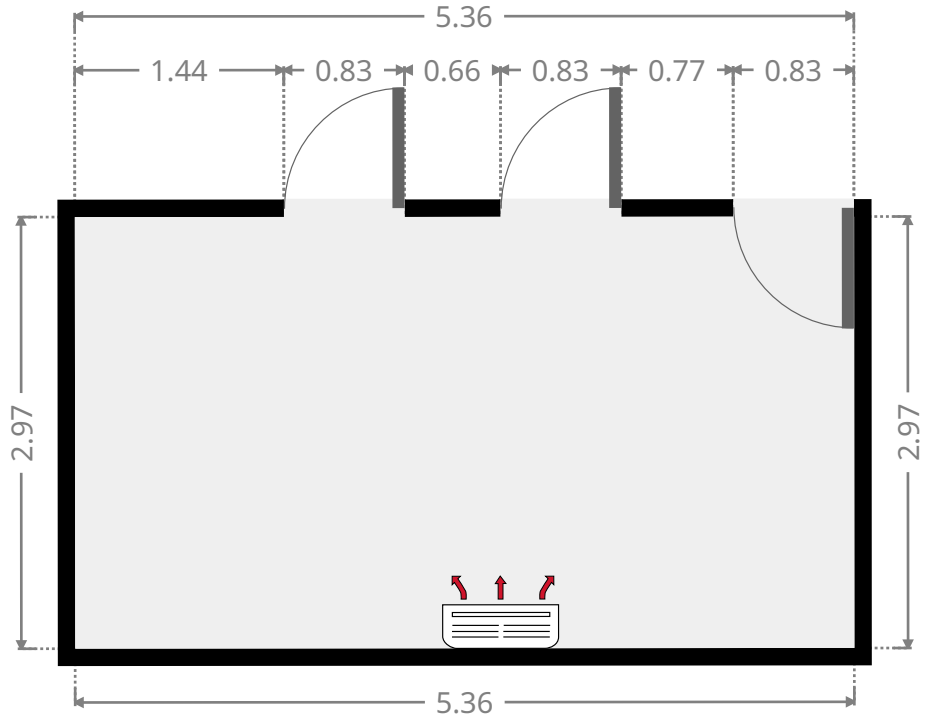
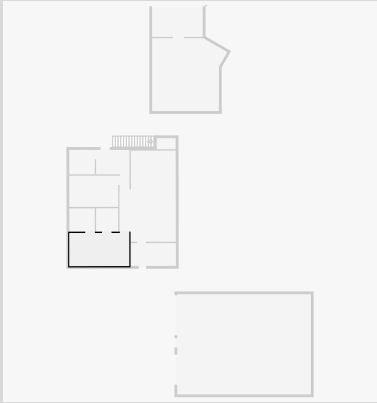

Bathroom

Width: 2.08 m
 Length: 2.28 m
 Area: 4.75 m²
 Perimeter: 8.73 m

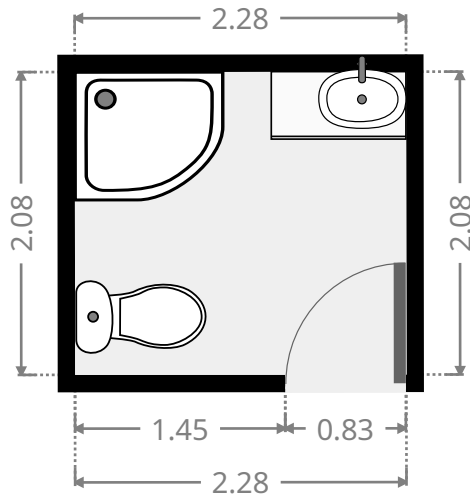
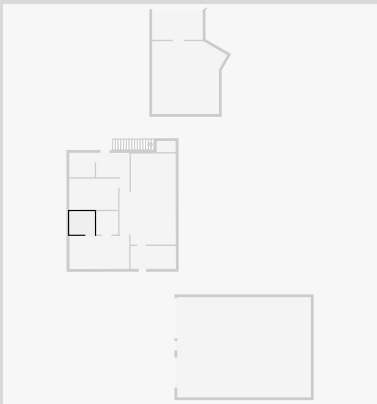

THIS FLOORPLAN IS PROVIDED WITHOUT WARRANTY OF ANY KIND. SENSOPIA DISCLAIMS ANY WARRANTY INCLUDING, WITHOUT LIMITATION, SATISFACTORY QUALITY OR ACCURACY OF DIMENSIONS.

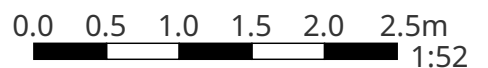

160 Newell's Road

WIR

Width: 1.98 m
 Length: 2.10 m
 Area: 4.17 m²
 Perimeter: 8.17 m

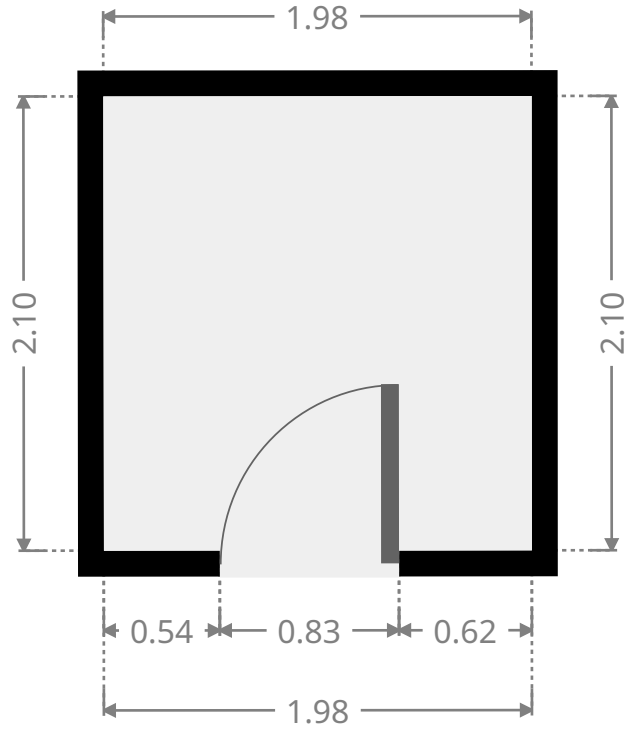
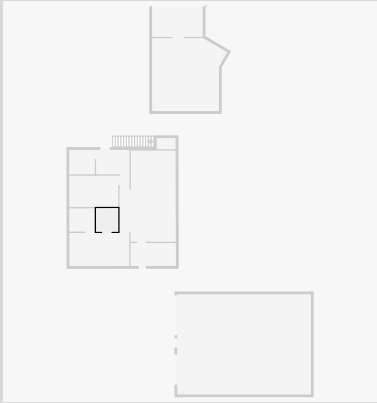

•
 Width: 1.00 m
 Length: 1.70 m
 Area: 1.70 m²
 Perimeter: 5.40 m

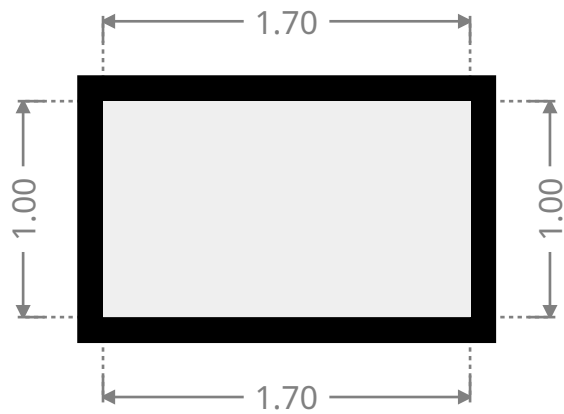
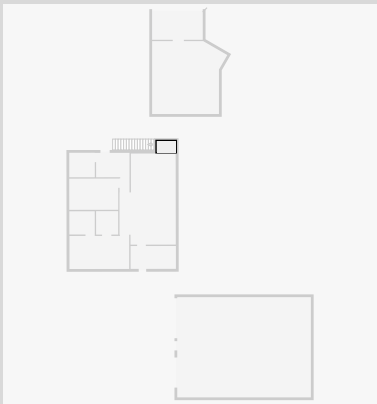

160 Newell's Road

Outdoor Entertainment Area

Width: 6.55 m
 Length: 6.75 m
 Area: 39.37 m²
 Perimeter: 25.14 m

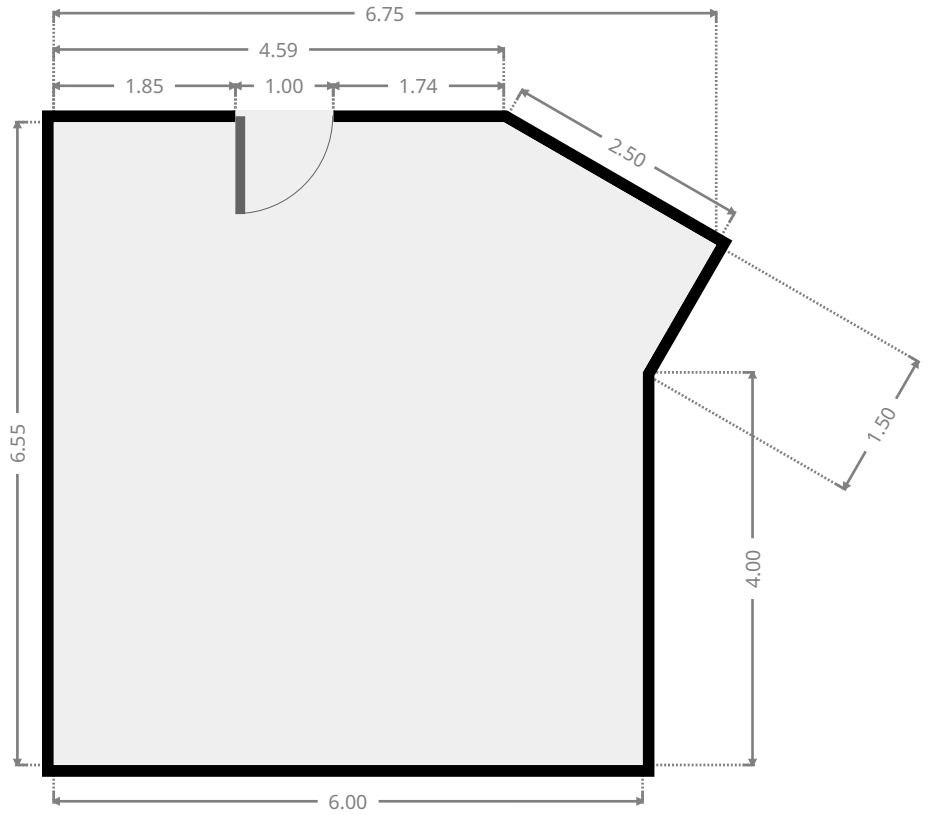
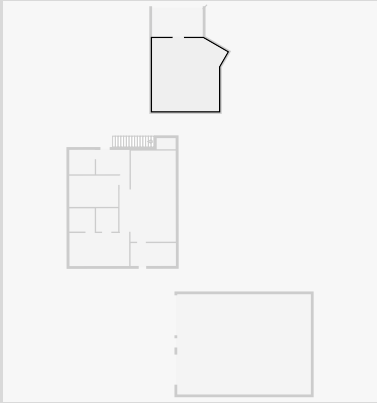

Pool Deck

Width: 2.50 m
 Length: 4.55 m
 Area: 11.37 m²
 Perimeter: 14.09 m

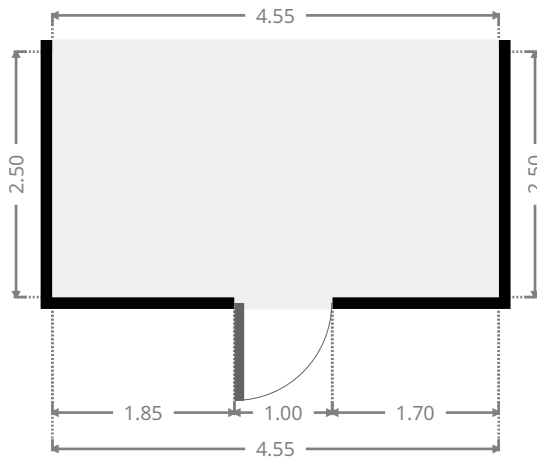
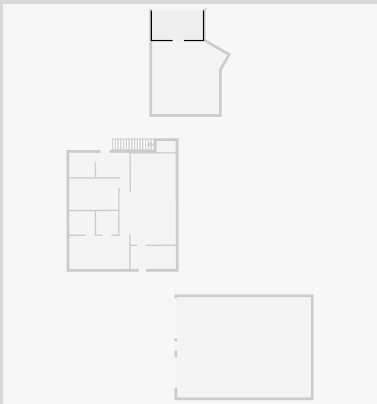

160 Newell's Road

Shed

Width: 9.00 m
Length: 12.00 m
Area: 108.00 m²
Perimeter: 42.00 m

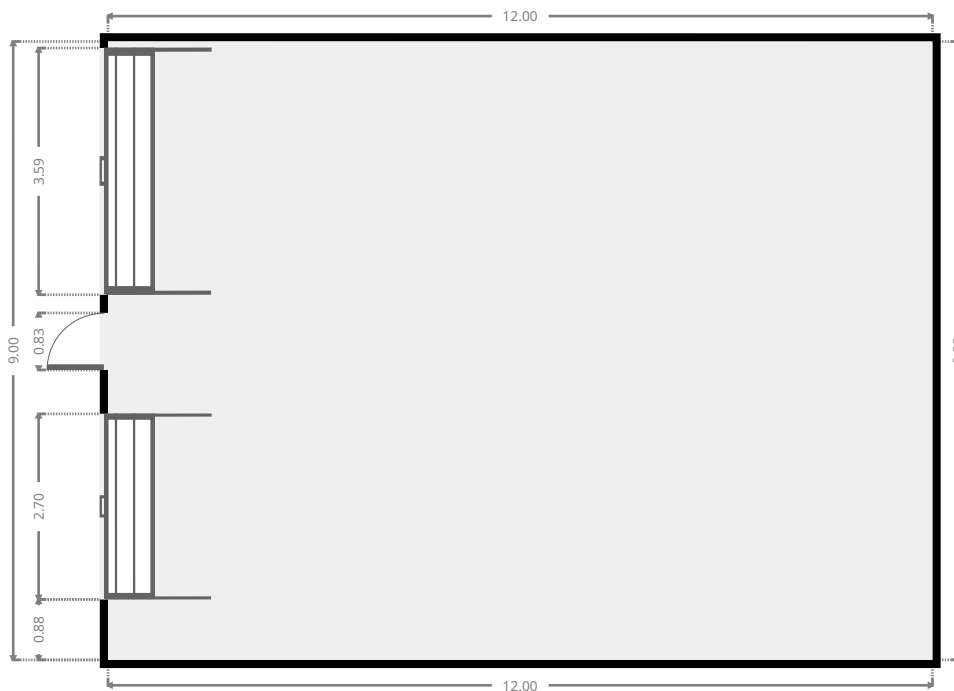
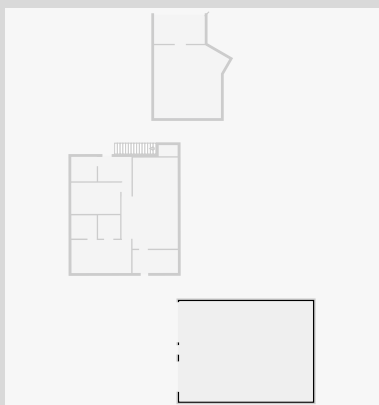

160 Newell's Road

1st Floor

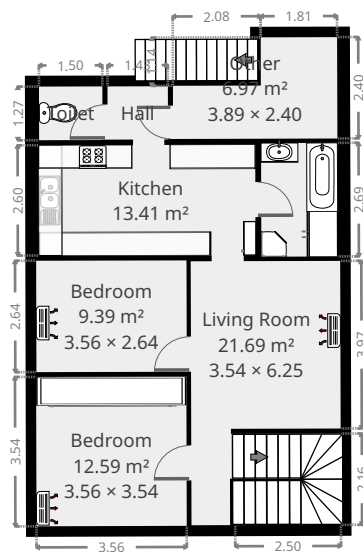

THIS FLOORPLAN IS PROVIDED WITHOUT WARRANTY OF ANY KIND. SENSOPIA DISCLAIMS ANY WARRANTY INCLUDING, WITHOUT LIMITATION, SATISFACTORY QUALITY OR ACCURACY OF DIMENSIONS.



160 Newell's Road

Hall

Width: 1.26 m
 Length: 1.43 m
 Area: 1.80 m²
 Perimeter: 5.38 m

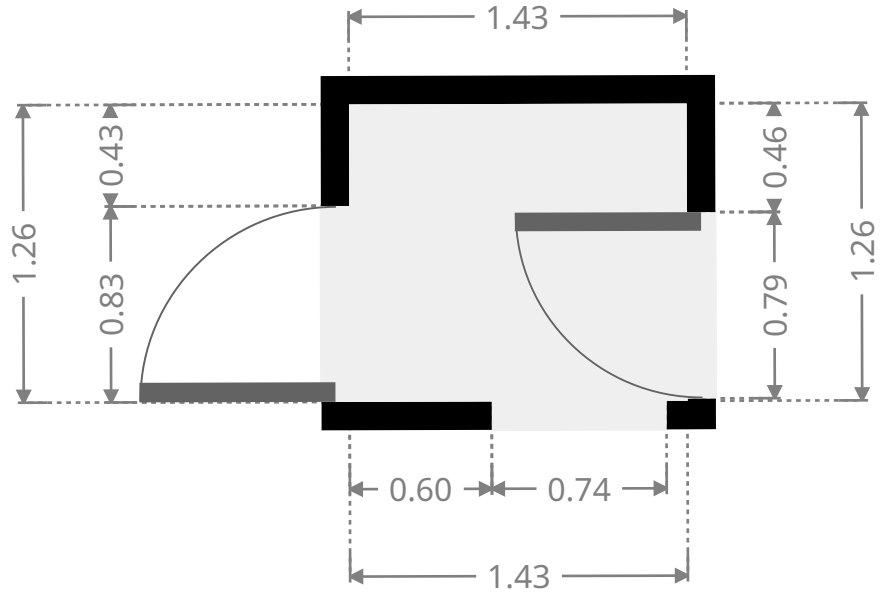
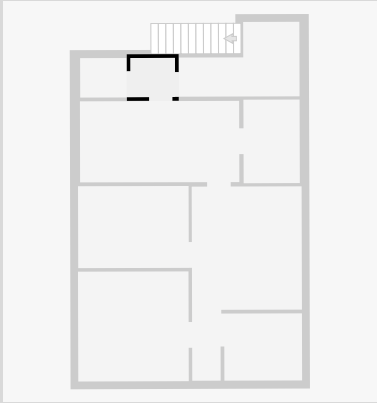

Toilet / Half Bath

Width: 1.27 m
 Length: 1.50 m
 Area: 1.91 m²
 Perimeter: 5.54 m

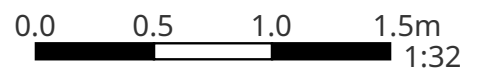
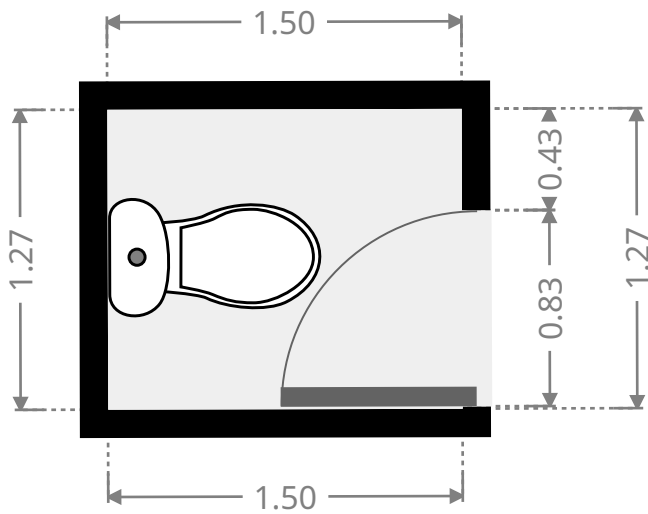
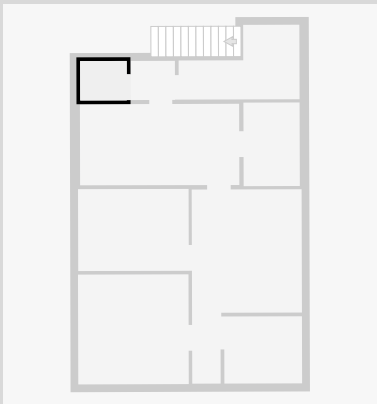

160 Newell's Road

Kitchen

Width: 2.62 m
 Length: 5.13 m
 Area: 13.41 m²
 Perimeter: 15.49 m

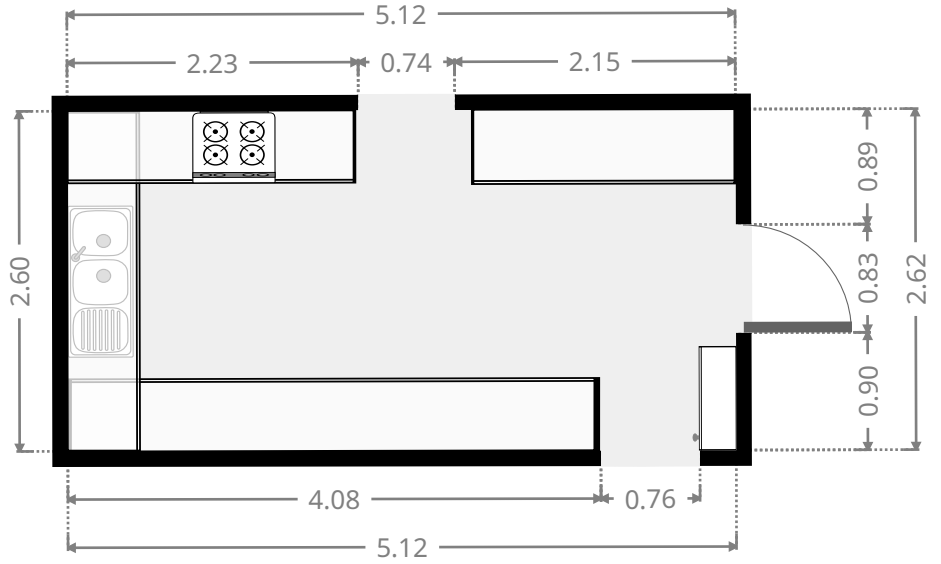
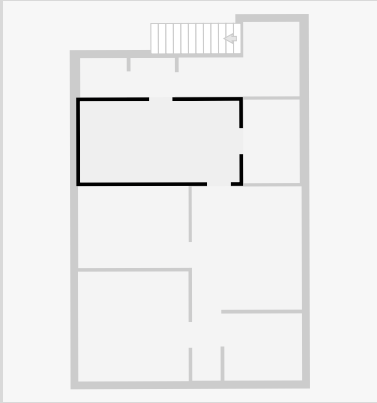

Bathroom

Width: 1.81 m
 Length: 2.69 m
 Area: 4.87 m²
 Perimeter: 9.00 m

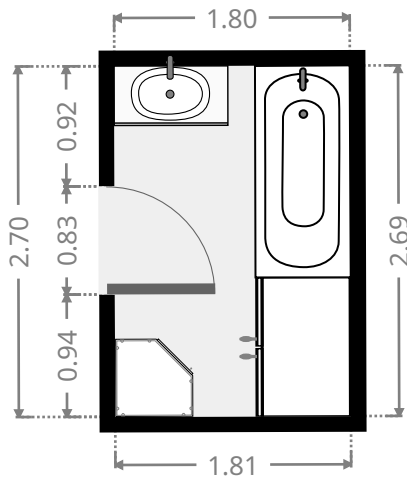
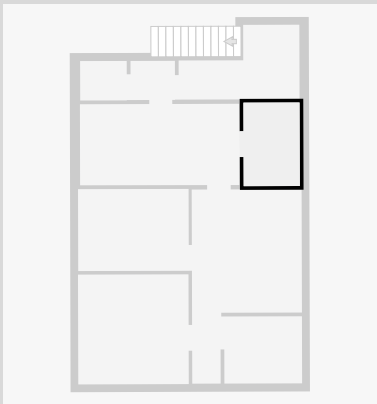

THIS FLOORPLAN IS PROVIDED WITHOUT WARRANTY OF ANY KIND. SENSOPIA DISCLAIMS ANY WARRANTY INCLUDING, WITHOUT LIMITATION, SATISFACTORY QUALITY OR ACCURACY OF DIMENSIONS.

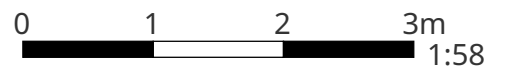

160 Newell's Road

Living Room

Width: 3.54 m
 Length: 6.25 m
 Area: 21.69 m²
 Perimeter: 26.98 m

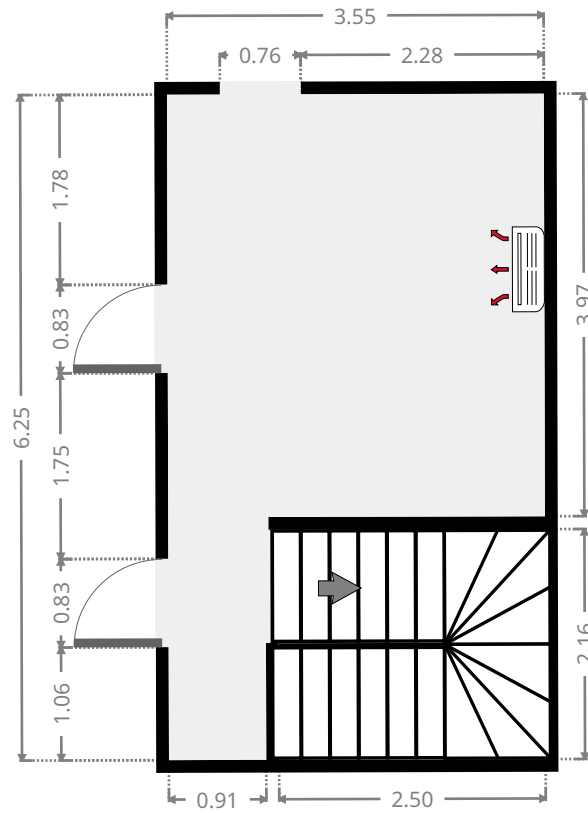
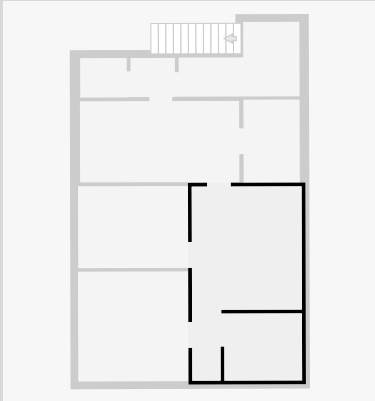

Bedroom

Width: 2.64 m
 Length: 3.56 m
 Area: 9.39 m²
 Perimeter: 12.40 m

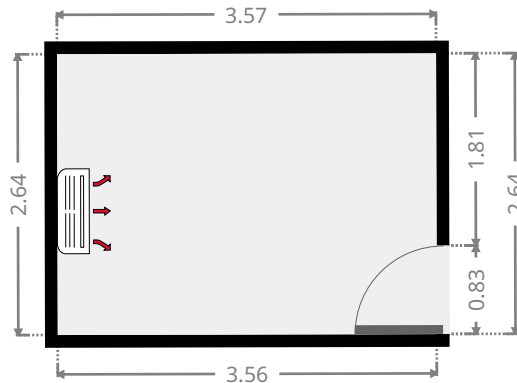
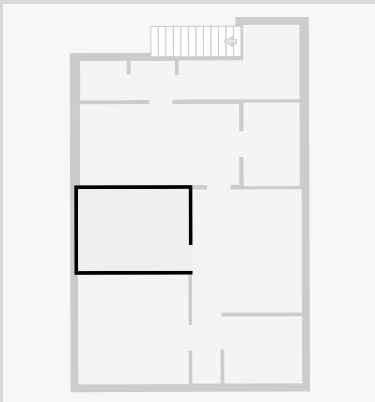

160 Newell's Road

Bedroom

Width: 3.54 m
 Length: 3.56 m
 Area: 12.59 m²
 Perimeter: 14.19 m

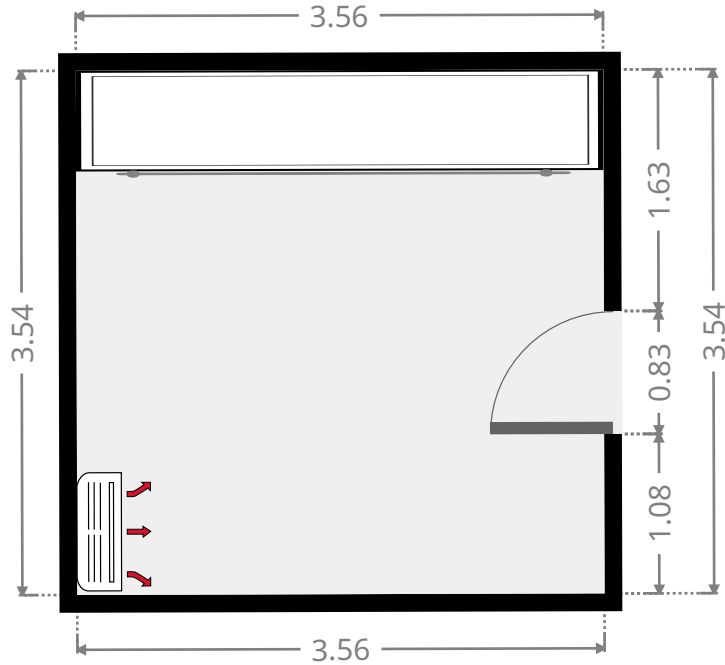
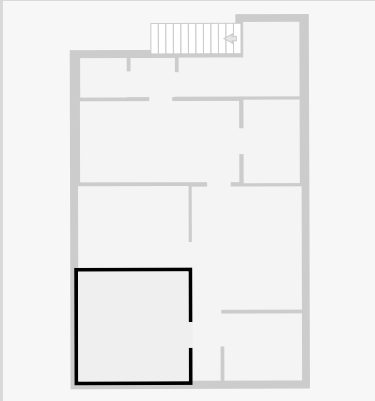

Other

Width: 2.40 m
 Length: 3.89 m
 Area: 6.97 m²
 Perimeter: 12.59 m

