

16 Tung Yeen Street

Ground Floor

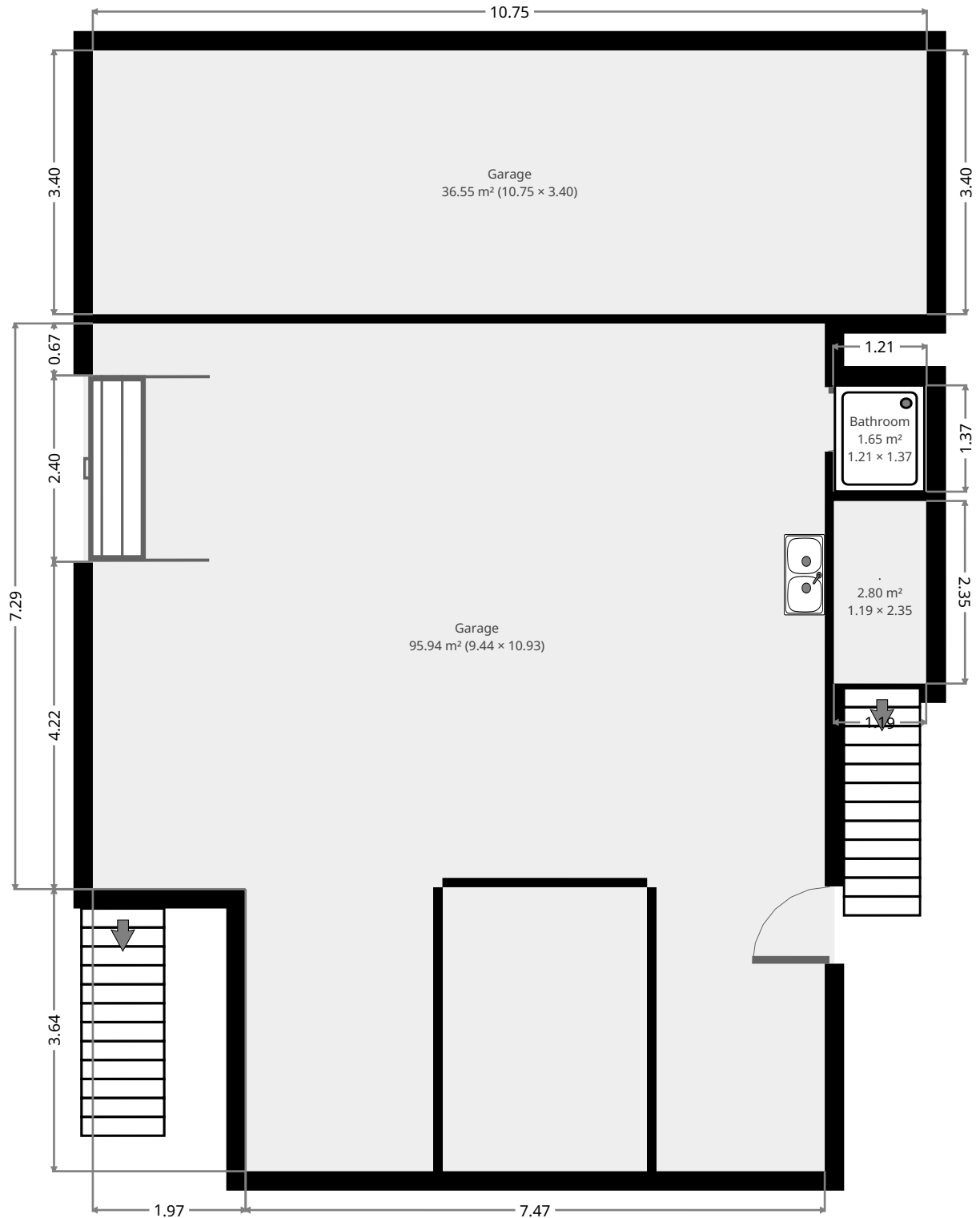

THIS FLOORPLAN IS PROVIDED WITHOUT WARRANTY OF ANY KIND. SENSOPIA DISCLAIMS ANY WARRANTY INCLUDING, WITHOUT LIMITATION, SATISFACTORY QUALITY OR ACCURACY OF DIMENSIONS.



16 Tung Yeen Street

Garage

Width: 9.44 m
Length: 10.93 m
Area: 95.94 m²
Perimeter: 40.72 m

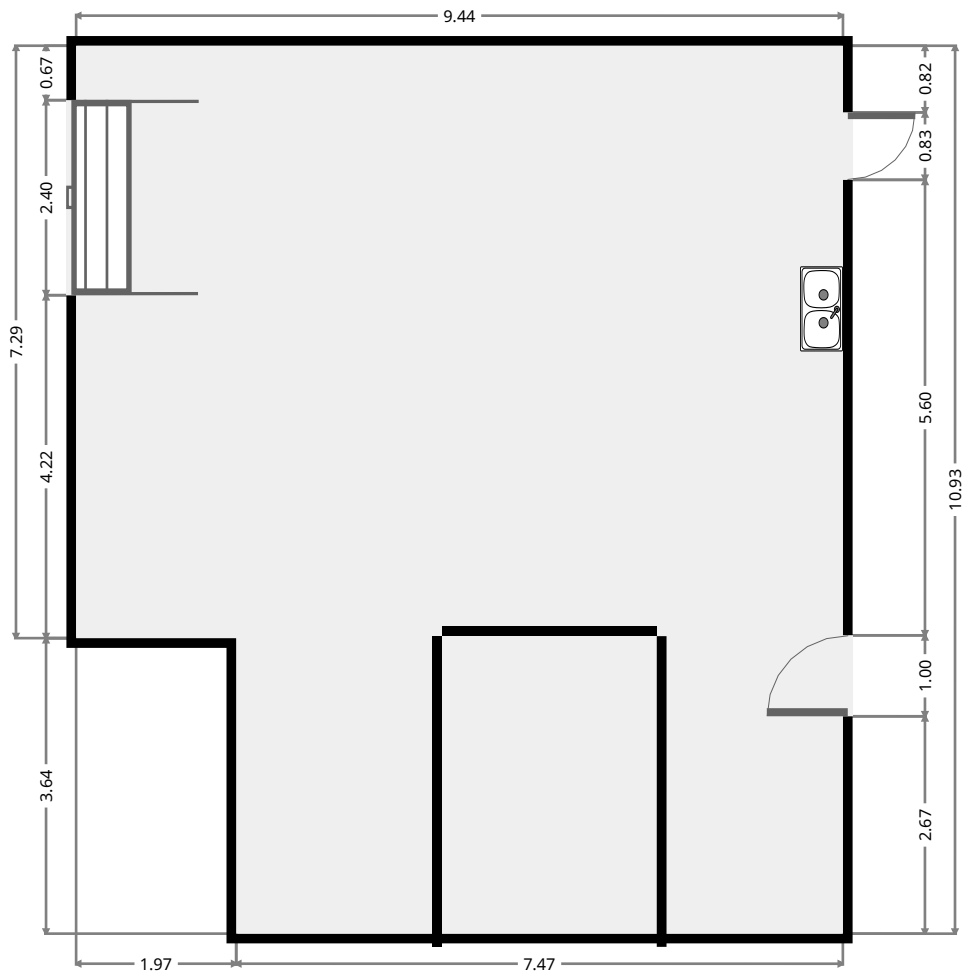
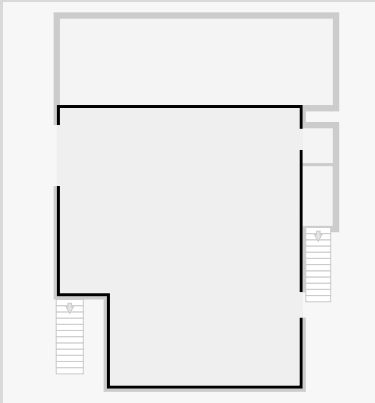

THIS FLOORPLAN IS PROVIDED WITHOUT WARRANTY OF ANY KIND. SENSOPIA DISCLAIMS ANY WARRANTY INCLUDING, WITHOUT LIMITATION, SATISFACTORY QUALITY OR ACCURACY OF DIMENSIONS.



16 Tung Yeen Street

Garage

Width: 3.40 m
Length: 10.75 m
Area: 36.55 m²
Perimeter: 28.30 m

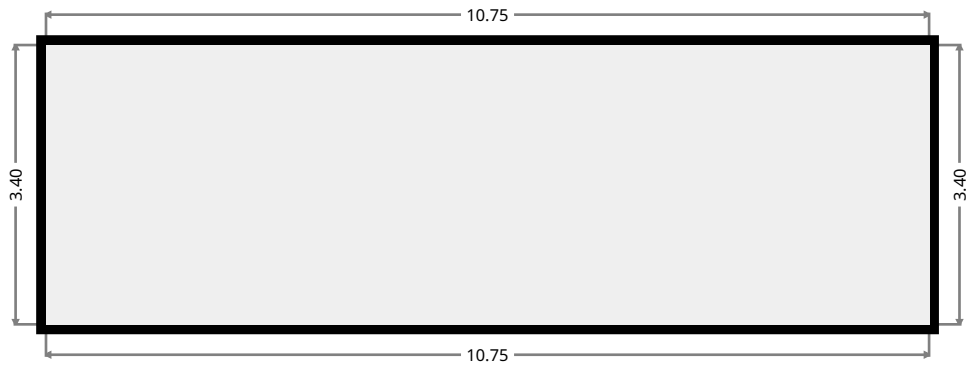
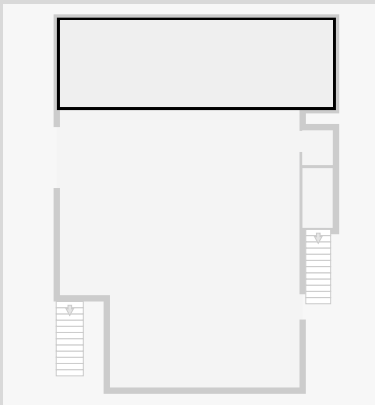

16 Tung Yeen Street

Bathroom

Width: 1.21 m
Length: 1.37 m
Area: 1.65 m²
Perimeter: 5.15 m

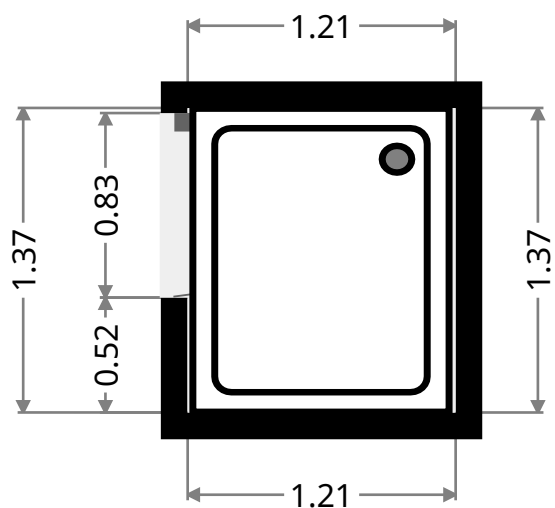
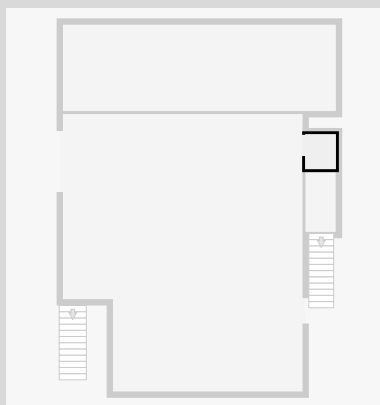

•
Width: 1.19 m
Length: 2.35 m
Area: 2.80 m²
Perimeter: 7.09 m

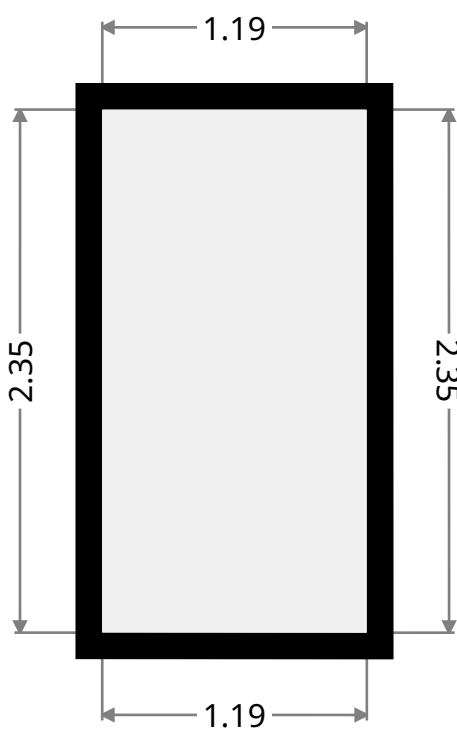
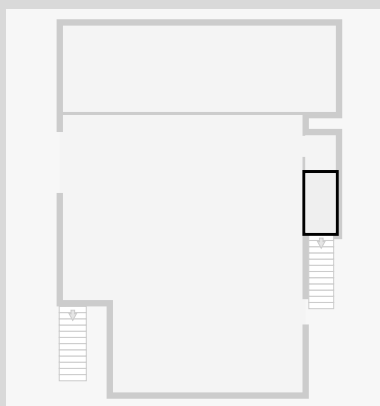

16 Tung Yeen Street

1st Floor



THIS FLOORPLAN IS PROVIDED WITHOUT WARRANTY OF ANY KIND. SENSOPIA DISCLAIMS ANY WARRANTY INCLUDING, WITHOUT LIMITATION, SATISFACTORY QUALITY OR ACCURACY OF DIMENSIONS.



16 Tung Yeen Street

Sunroom

Width: 1.73 m
 Length: 3.51 m
 Area: 6.08 m²
 Perimeter: 10.48 m

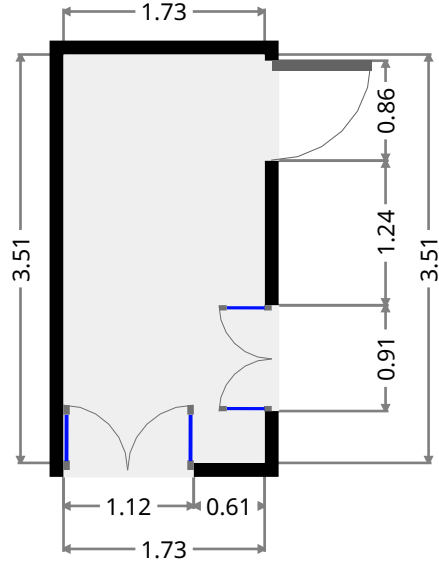

Living Room

Width: 4.50 m
 Length: 4.57 m
 Area: 20.55 m²
 Perimeter: 18.13 m

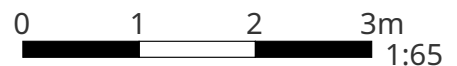
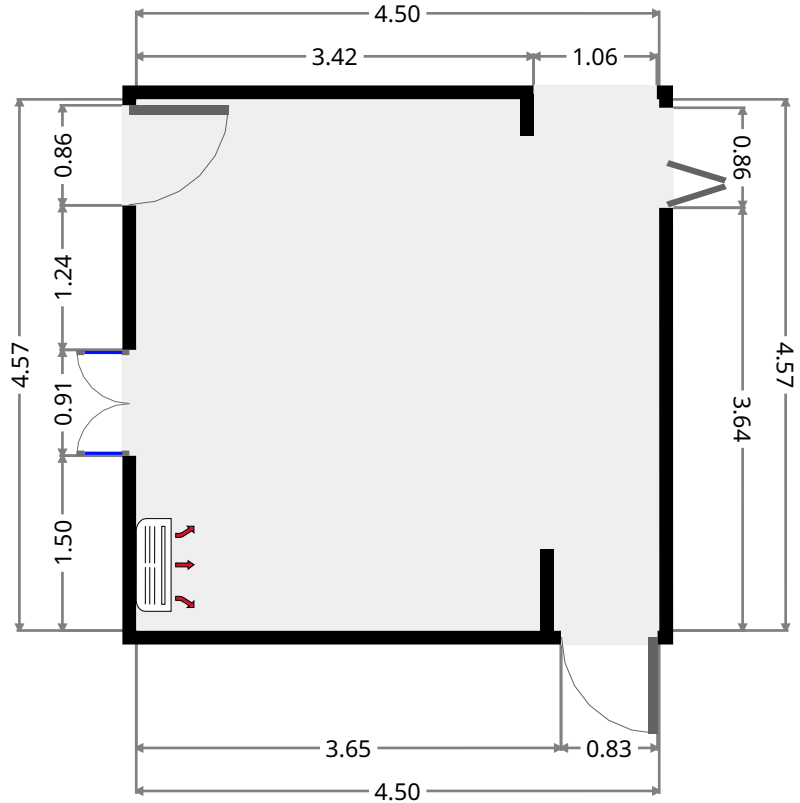
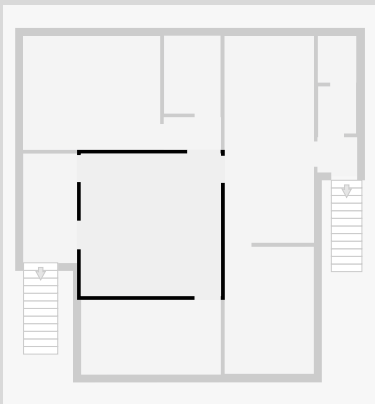

THIS FLOORPLAN IS PROVIDED WITHOUT WARRANTY OF ANY KIND. SENSOPIA DISCLAIMS ANY WARRANTY INCLUDING, WITHOUT LIMITATION, SATISFACTORY QUALITY OR ACCURACY OF DIMENSIONS.

16 Tung Yeen Street

Hall

Width: 1.06 m
 Length: 1.84 m
 Area: 1.94 m²
 Perimeter: 5.79 m

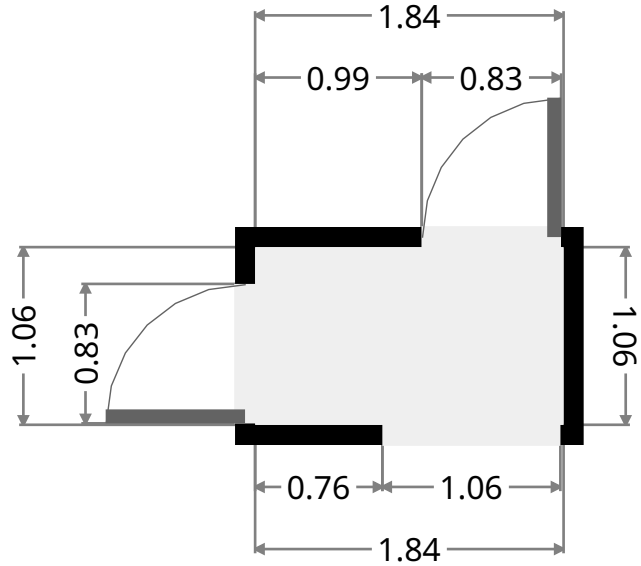

Bedroom

Width: 2.41 m
 Length: 4.48 m
 Area: 10.78 m²
 Perimeter: 13.77 m

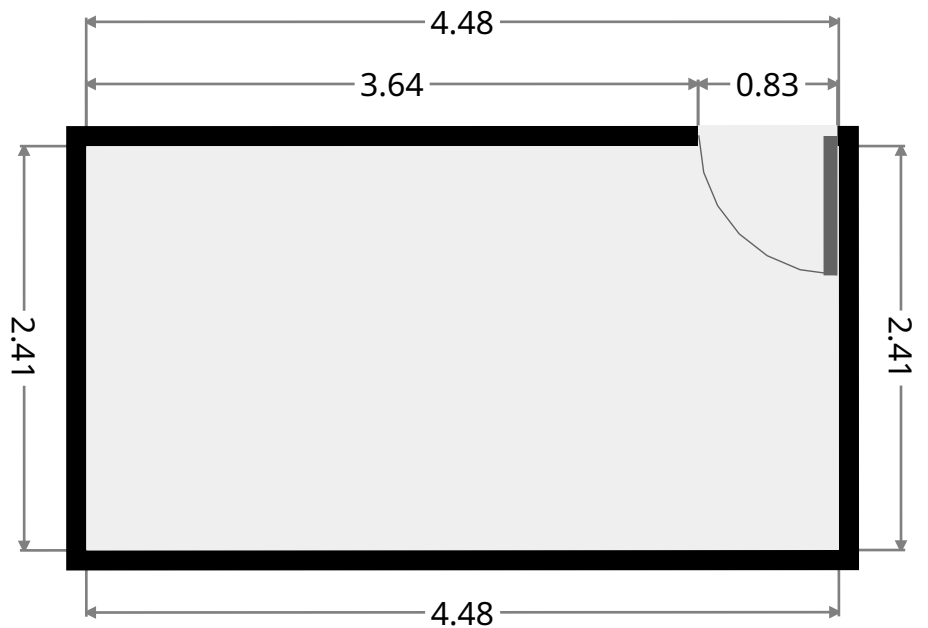
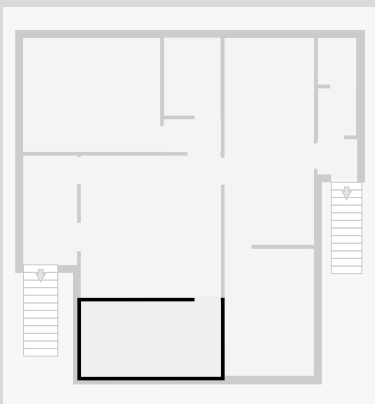

16 Tung Yeen Street

Master Bedroom

Width: 3.65 m
 Length: 4.40 m
 Area: 16.07 m²
 Perimeter: 16.11 m

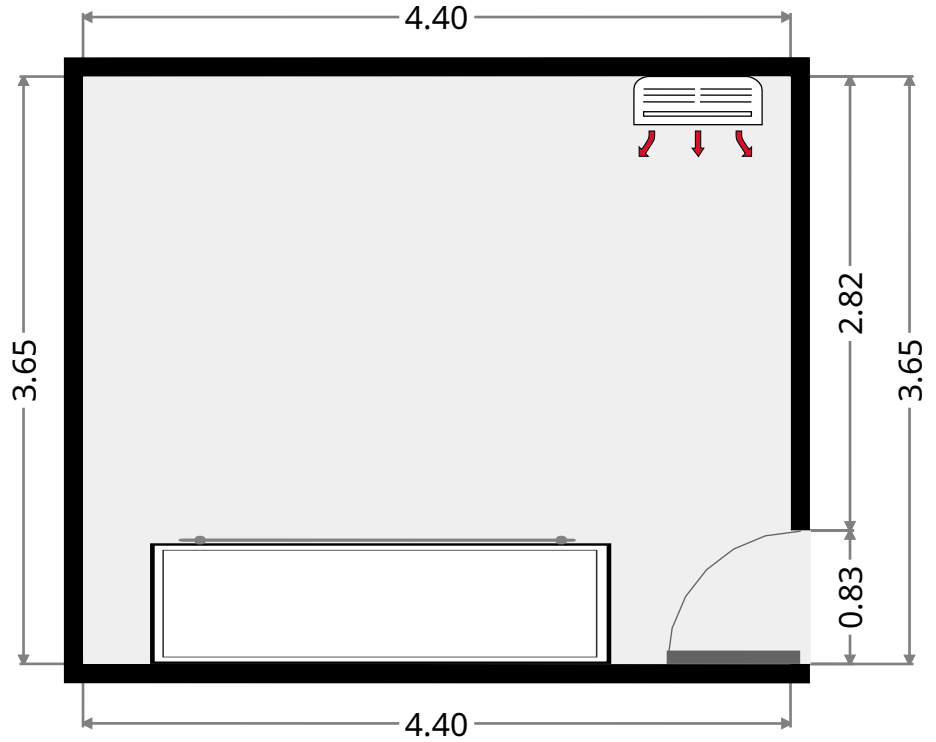

Bathroom

Width: 1.81 m
 Length: 2.50 m
 Area: 4.53 m²
 Perimeter: 8.62 m

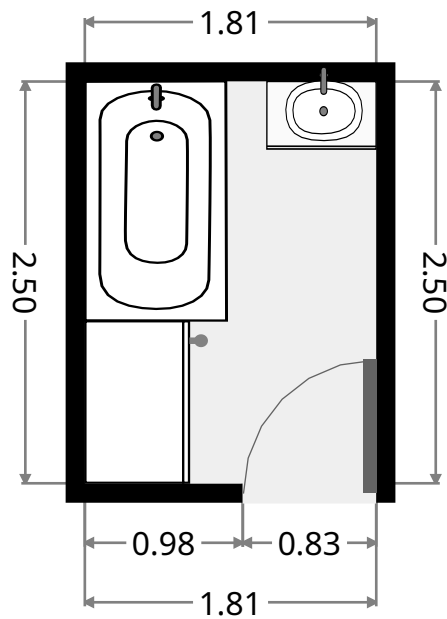

16 Tung Yeen Street

Kitchen/Dining

Width: 2.87 m
Length: 6.63 m
Area: 19.03 m²
Perimeter: 19.00 m

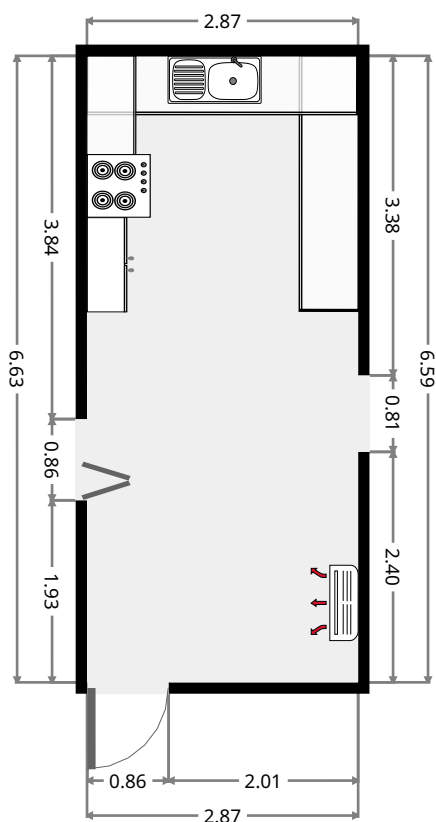
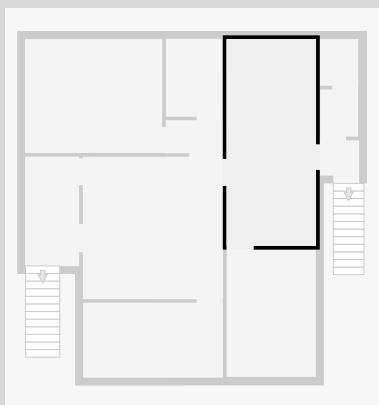

Bedroom

Width: 2.86 m
Length: 4.07 m
Area: 11.65 m²
Perimeter: 13.87 m

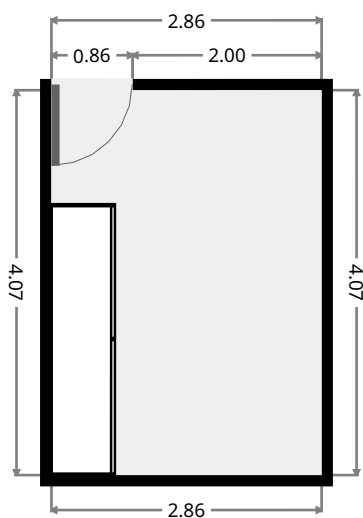
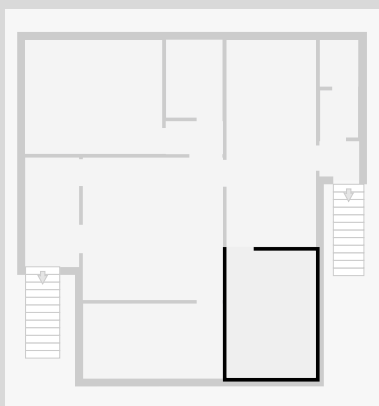

16 Tung Yeen Street

Hall

Width: 1.13 m
 Length: 1.27 m
 Area: 1.44 m²
 Perimeter: 4.81 m

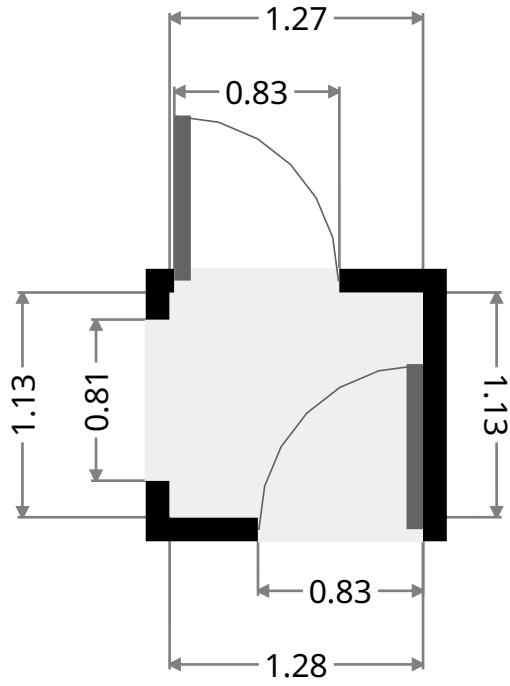
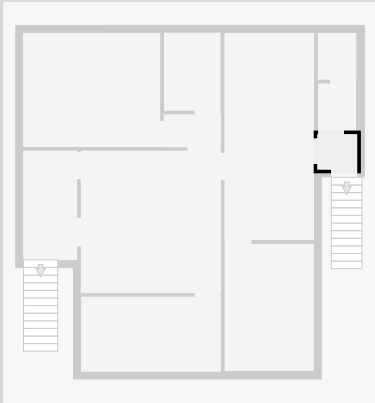

Hall

Width: 1.22 m
 Length: 1.51 m
 Area: 1.84 m²
 Perimeter: 5.45 m

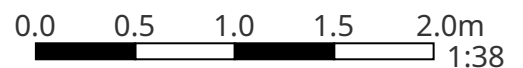
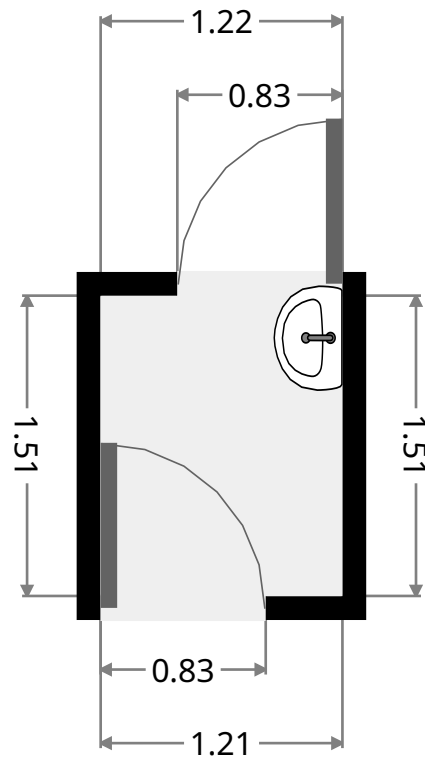

16 Tung Yeen Street

Toilet / Half Bath

Width:	1.23 m
Length:	1.50 m
Area	1.84 m ²
Perimeter	5.46 m

