

16 Meyhenberg Court

Created on
2021-03-23

Floors
2

▼ Ground Floor

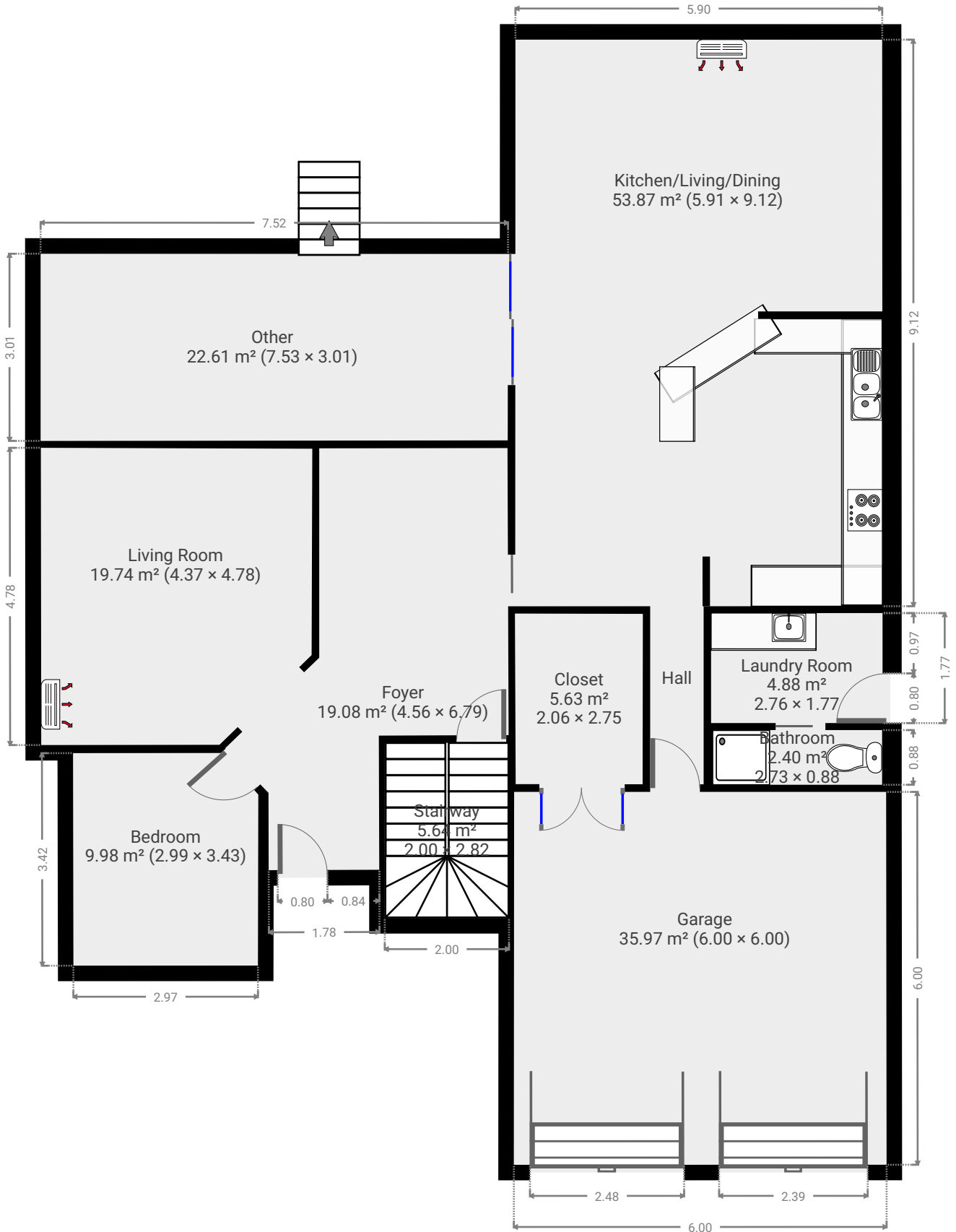

▼ **Foyer**
Ground Floor

WIDTH: 4.56 m • LENGTH: 6.79 m
AREA: 19.08 m² • PERIMETER: 21.40 m

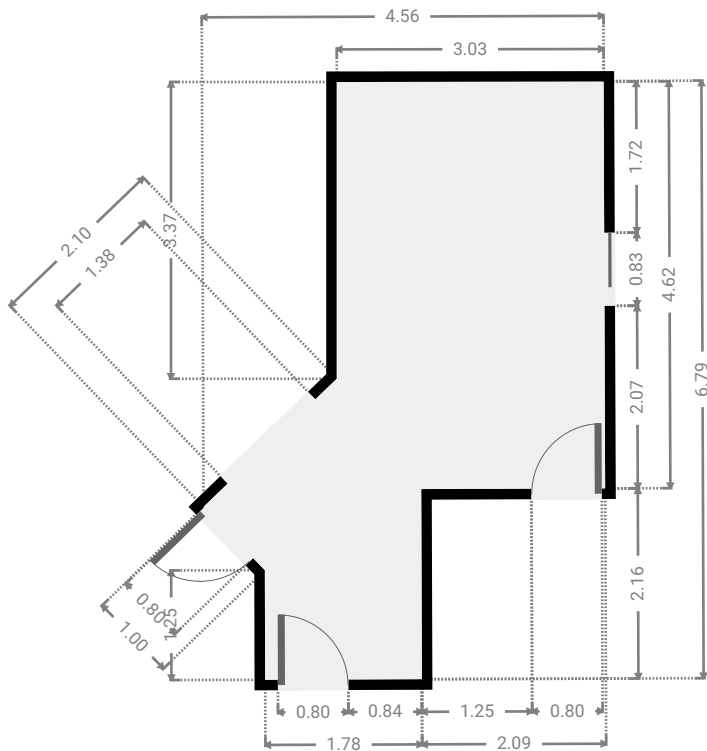
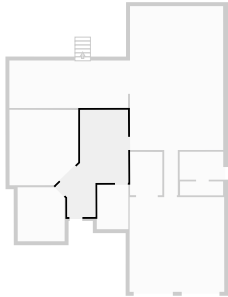

▼ **Bedroom**
Ground Floor

WIDTH: 2.99 m • LENGTH: 3.43 m
AREA: 9.98 m² • PERIMETER: 12.42 m

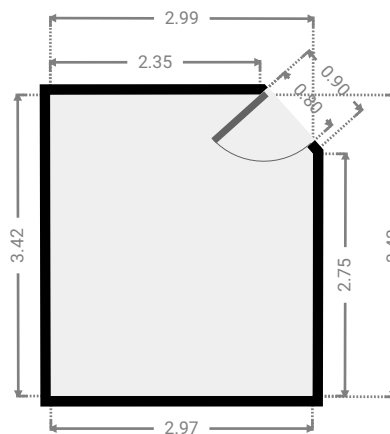
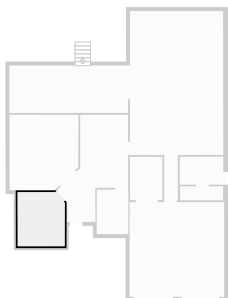

▼ Living Room Ground Floor

WIDTH: 4.37 m • LENGTH: 4.78 m
AREA: 19.74 m² • PERIMETER: 17.42 m

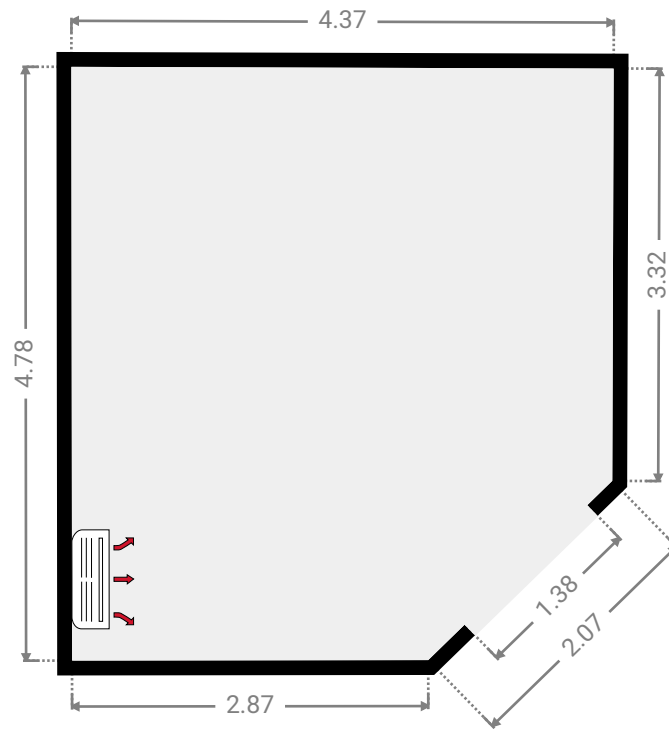
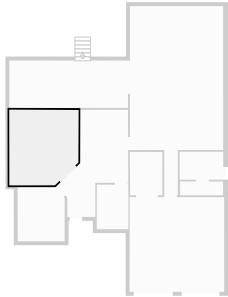

▼ Stairway Ground Floor

WIDTH: 2.00 m • LENGTH: 2.82 m
AREA: 5.64 m² • PERIMETER: 9.64 m

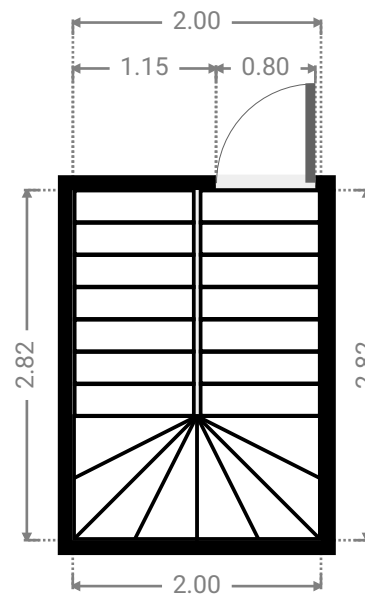
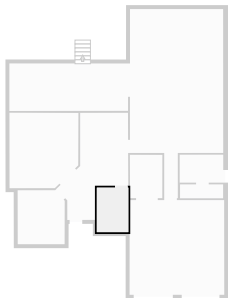

▼ Kitchen/Living/Dining
Ground Floor

WIDTH: 5.91 m • LENGTH: 9.12 m
AREA: 53.87 m² • PERIMETER: 30.05 m

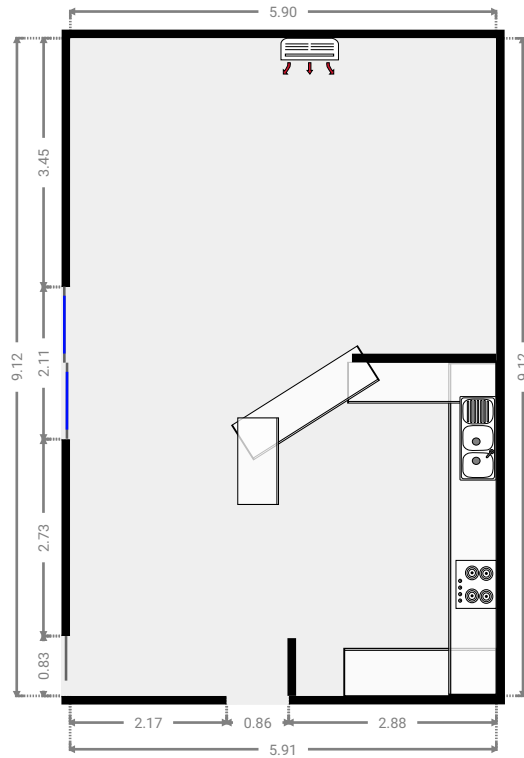
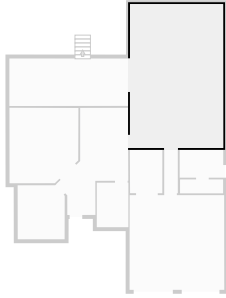

▼ Other
Ground Floor

WIDTH: 7.53 m • LENGTH: 3.01 m
AREA: 22.61 m² • PERIMETER: 21.06 m

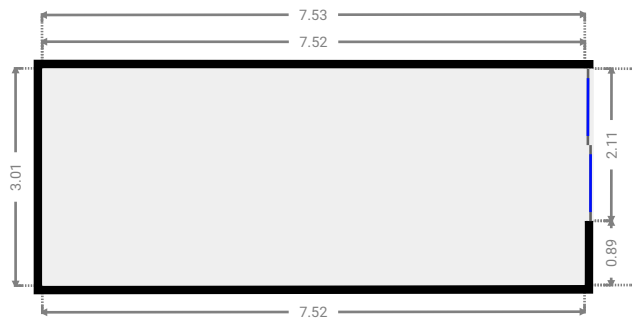
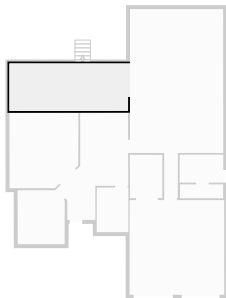

▼ Hall Ground Floor

WIDTH: 0.86 m • LENGTH: 2.75 m
AREA: 2.36 m² • PERIMETER: 7.21 m

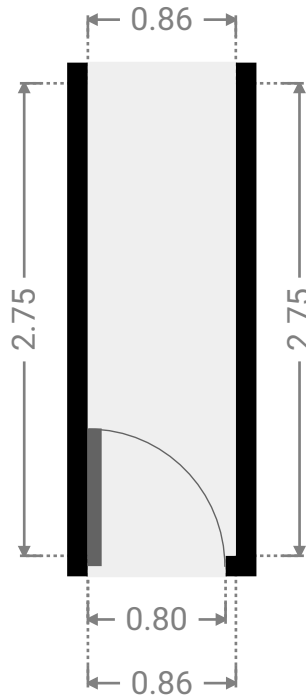
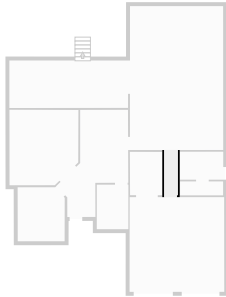

▼ Laundry Room Ground Floor

WIDTH: 2.76 m • LENGTH: 1.77 m
AREA: 4.88 m² • PERIMETER: 9.06 m

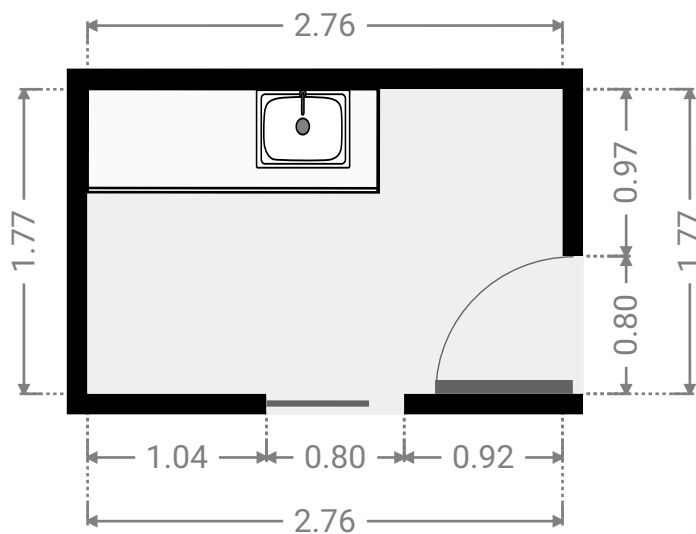
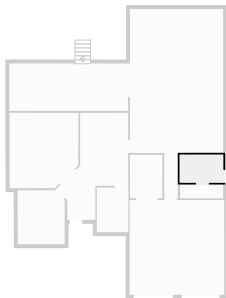

▼ Bathroom Ground Floor

WIDTH: 2.73 m • LENGTH: 0.88 m
AREA: 2.40 m² • PERIMETER: 7.22 m

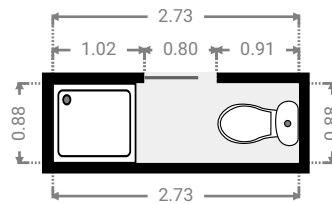
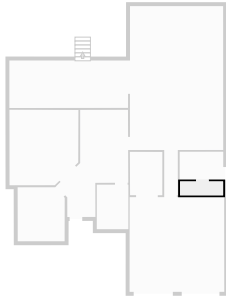

▼ Garage Ground Floor

WIDTH: 6.00 m • LENGTH: 6.00 m
AREA: 35.97 m² • PERIMETER: 23.99 m

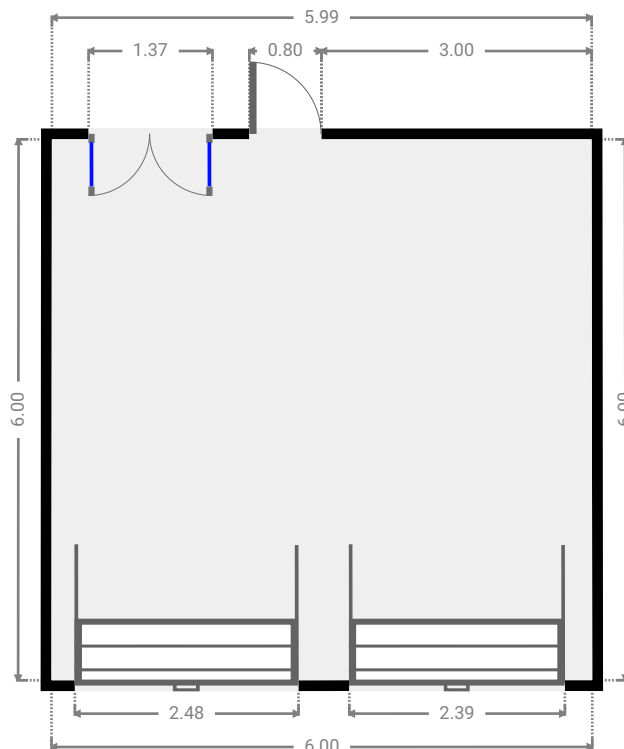
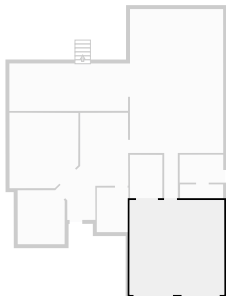

▼ **Closet**
Ground Floor

WIDTH: 2.06 m • LENGTH: 2.75 m
AREA: 5.63 m² • PERIMETER: 9.59 m

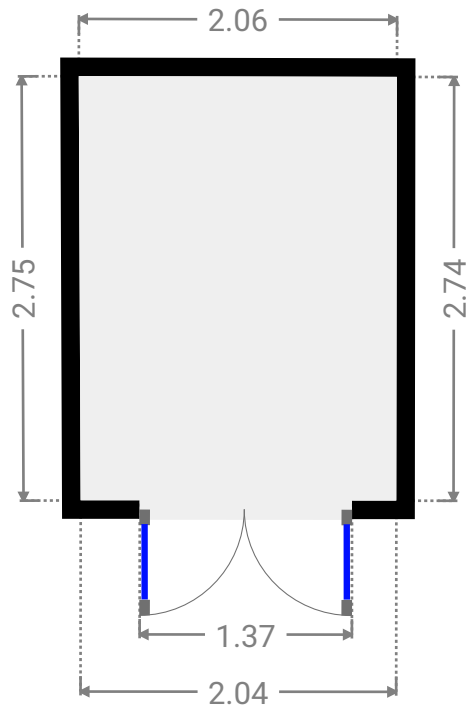
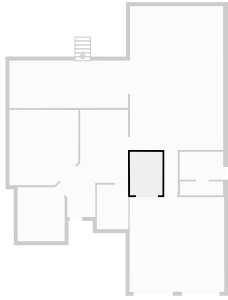

▼ 1st Floor

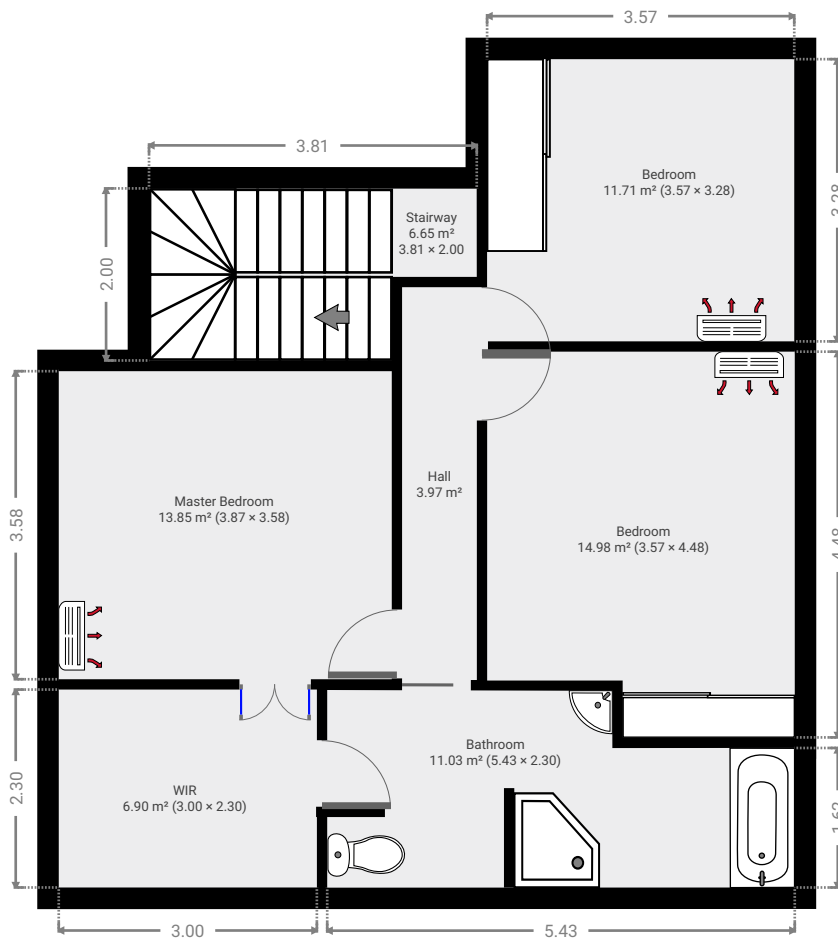

▼ **Bedroom**
1st Floor

WIDTH: 3.28 m • LENGTH: 3.57 m
AREA: 11.71 m² • PERIMETER: 13.70 m

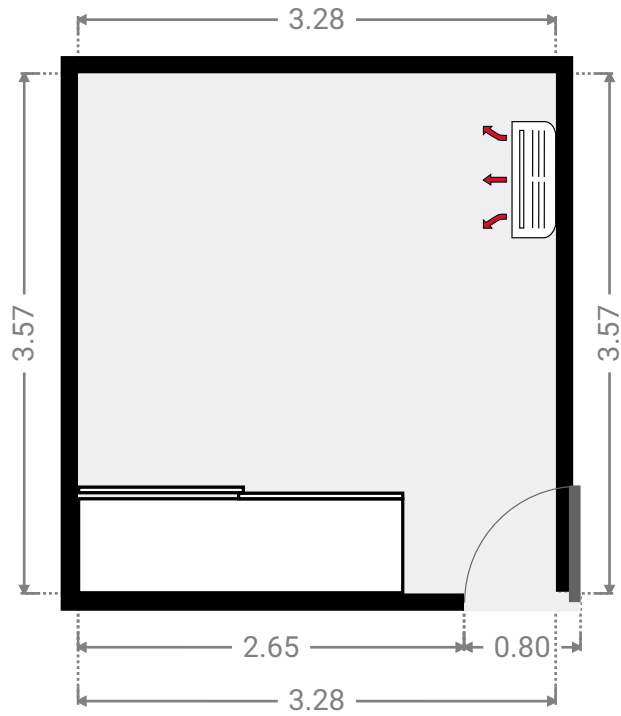
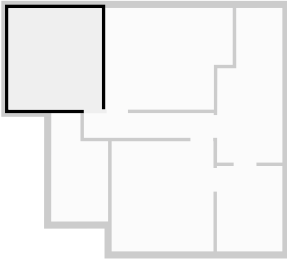

▼ **Hall**
1st Floor

WIDTH: 4.56 m • LENGTH: 0.87 m
AREA: 3.97 m² • PERIMETER: 10.87 m

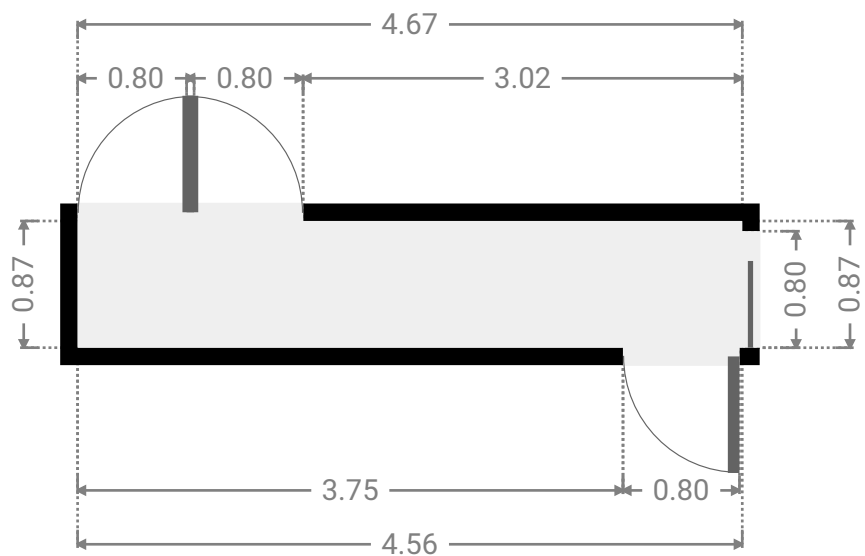
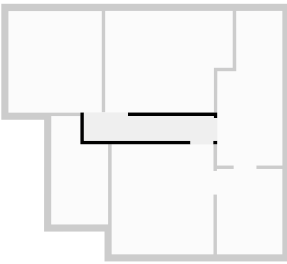

▼ Bedroom 1st Floor

WIDTH: 4.53 m • LENGTH: 3.58 m
AREA: 14.98 m² • PERIMETER: 16.11 m

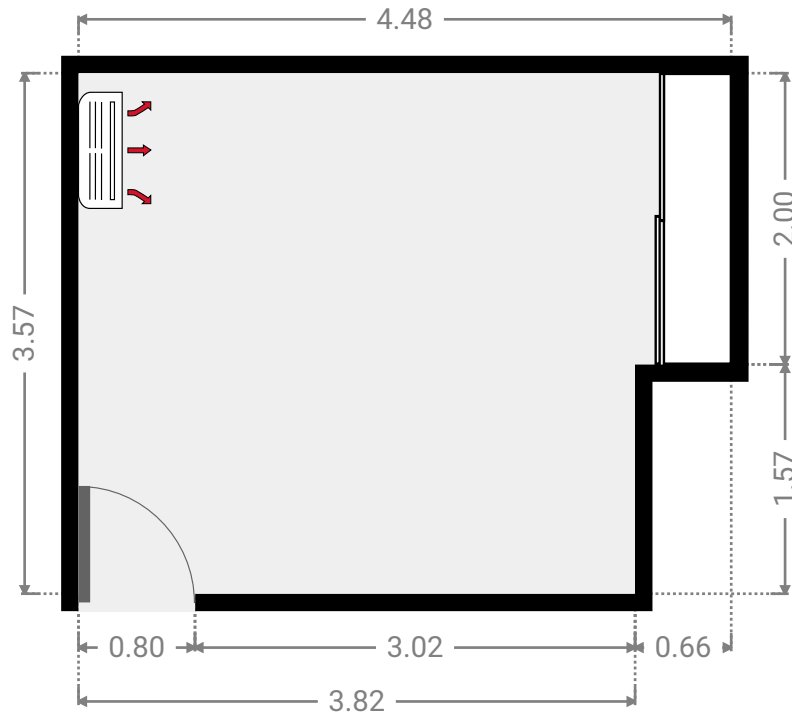
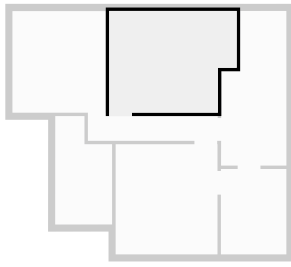

▼ Stairway 1st Floor

WIDTH: 2.00 m • LENGTH: 3.82 m
AREA: 6.65 m² • PERIMETER: 11.61 m

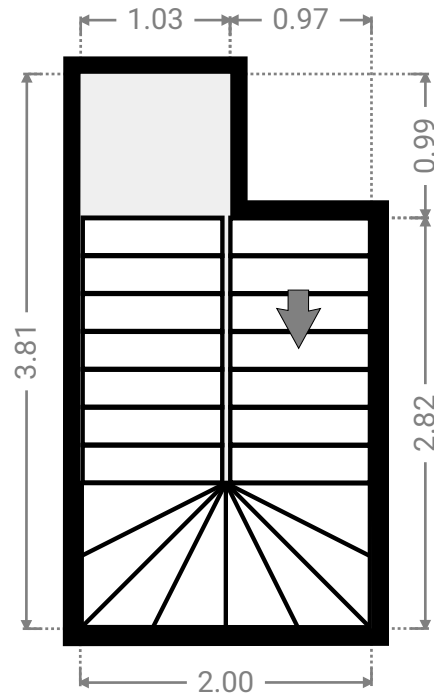
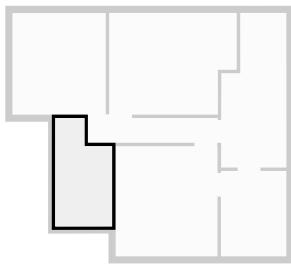

▼ Master Bedroom 1st Floor

WIDTH: 3.58 m • LENGTH: 3.87 m
AREA: 13.85 m² • PERIMETER: 14.90 m

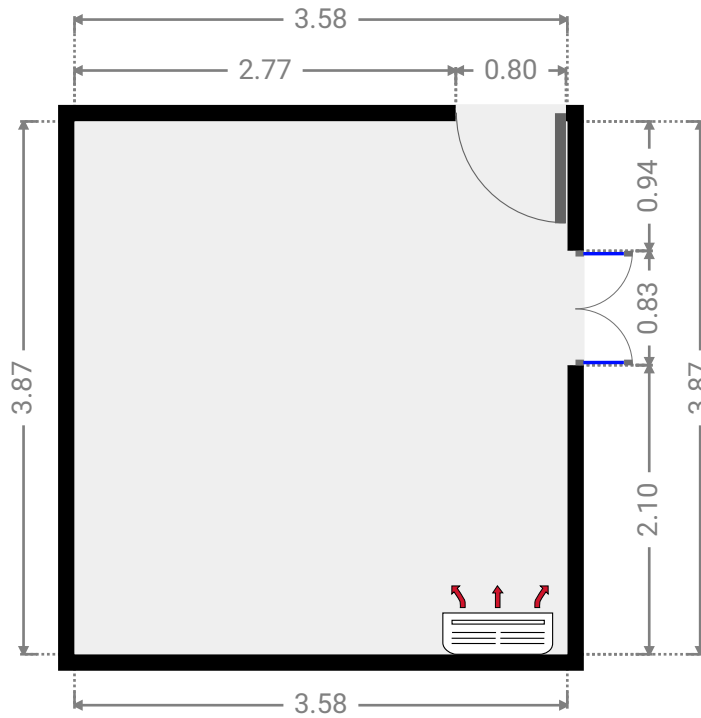
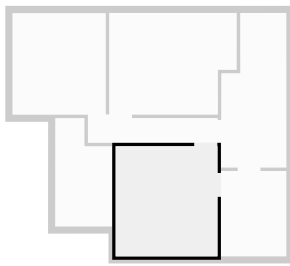

▼ WIR 1st Floor

WIDTH: 2.30 m • LENGTH: 3.00 m
AREA: 6.90 m² • PERIMETER: 10.60 m

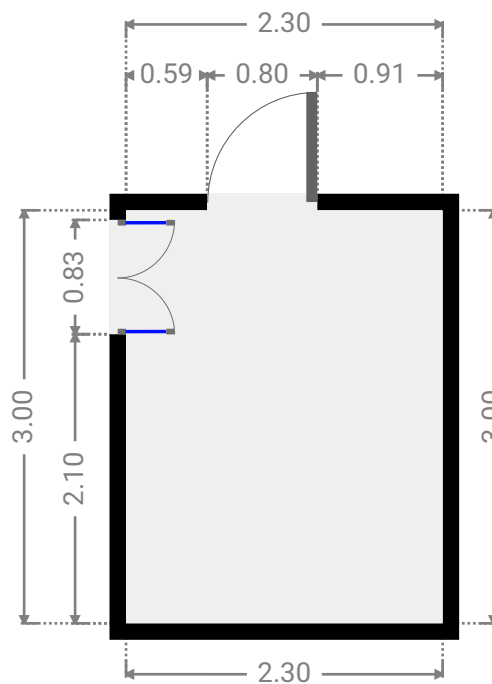
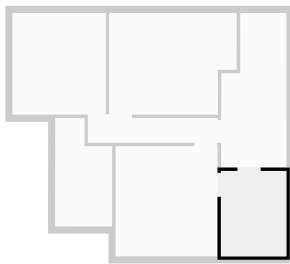

▼ Bathroom 1st Floor

WIDTH: 2.30 m • LENGTH: 5.43 m
AREA: 11.03 m² • PERIMETER: 15.45 m

