

16 Esplande

Created on
2021-09-13

Floors
2

▼ Ground Floor

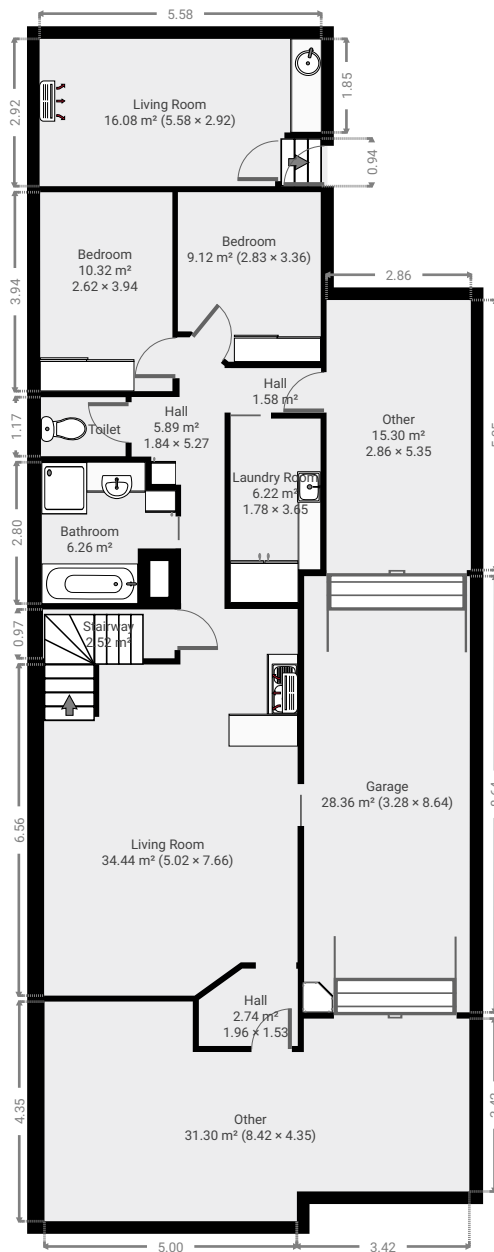
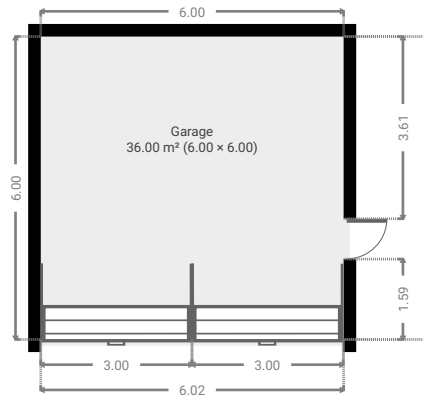

▼ Hall Ground Floor

WIDTH: 1.96 m • LENGTH: 1.53 m
AREA: 2.74 m² • PERIMETER: 6.56 m

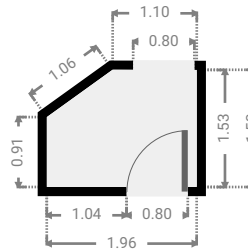

▼ Living Room Ground Floor

WIDTH: 5.02 m • LENGTH: 7.66 m
AREA: 34.44 m² • PERIMETER: 24.91 m

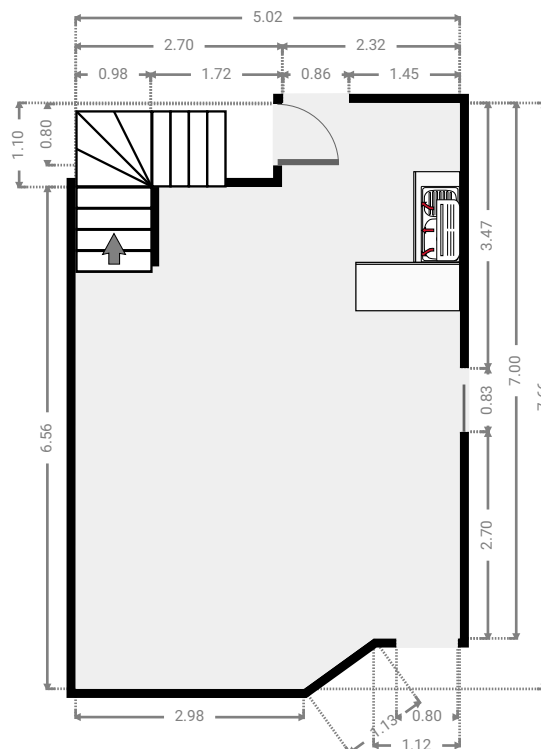

▼ Garage Ground Floor

WIDTH: 3.28 m • LENGTH: 8.64 m
AREA: 28.36 m² • PERIMETER: 23.84 m

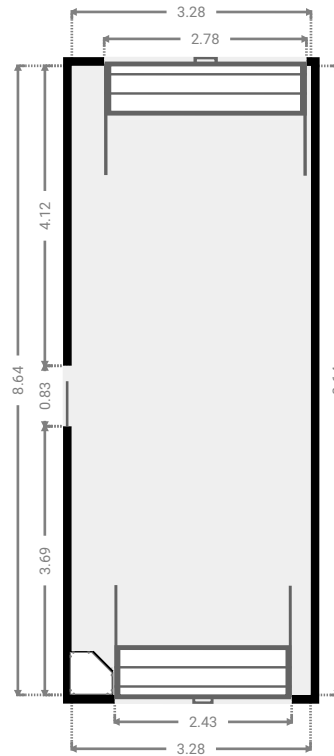

▼ Other Ground Floor

WIDTH: 2.86 m • LENGTH: 5.35 m
AREA: 15.30 m² • PERIMETER: 16.42 m

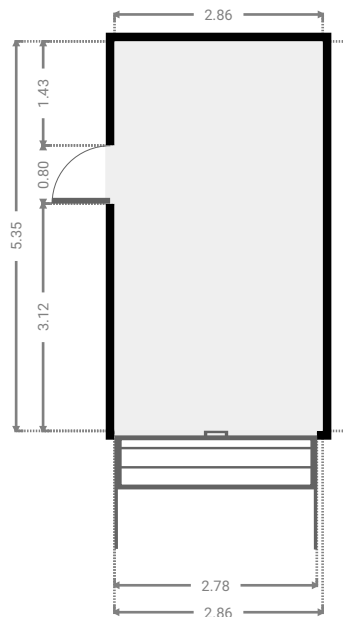

▼ Stairway Ground Floor

WIDTH: 2.61 m • LENGTH: 0.97 m
AREA: 2.52 m² • PERIMETER: 7.14 m

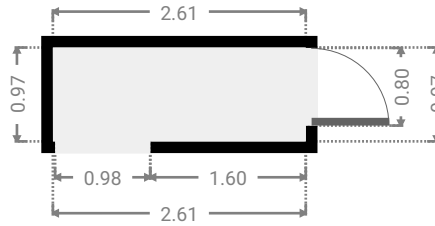

▼ Hall Ground Floor

WIDTH: 1.84 m • LENGTH: 5.27 m
AREA: 5.89 m² • PERIMETER: 13.94 m

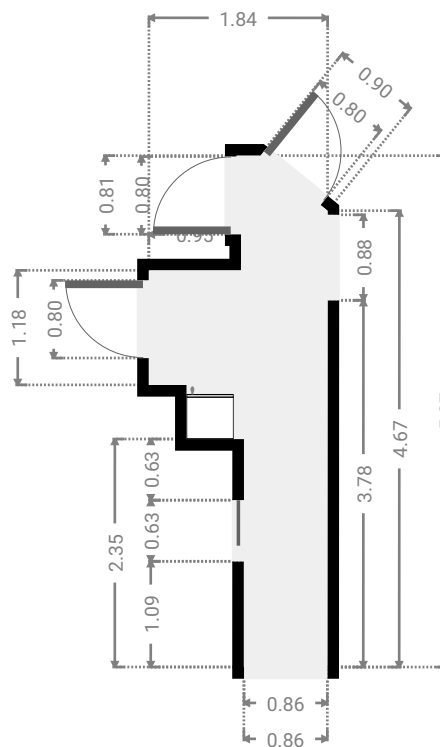

▼ Bathroom Ground Floor

WIDTH: 2.65 m • LENGTH: 2.80 m
AREA: 6.26 m² • PERIMETER: 10.90 m

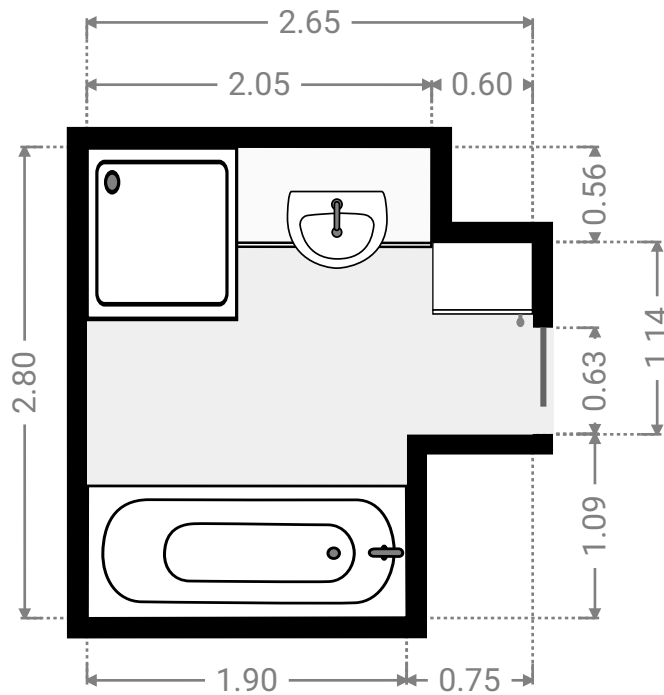
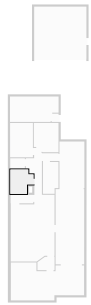

▼ Toilet Ground Floor

WIDTH: 1.68 m • LENGTH: 1.17 m
AREA: 1.96 m² • PERIMETER: 5.69 m

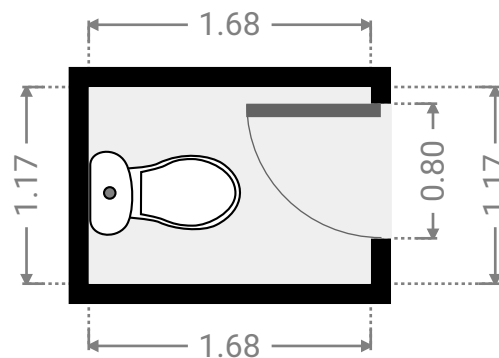

▼ Bedroom Ground Floor

WIDTH: 2.62 m • LENGTH: 3.94 m
AREA: 10.32 m² • PERIMETER: 13.12 m

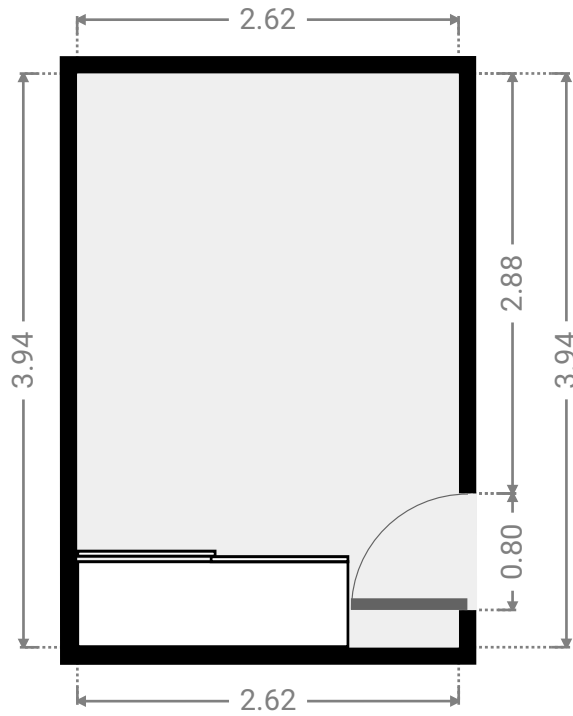
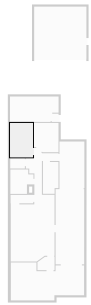

▼ Bedroom Ground Floor

WIDTH: 2.83 m • LENGTH: 3.36 m
AREA: 9.12 m² • PERIMETER: 11.99 m

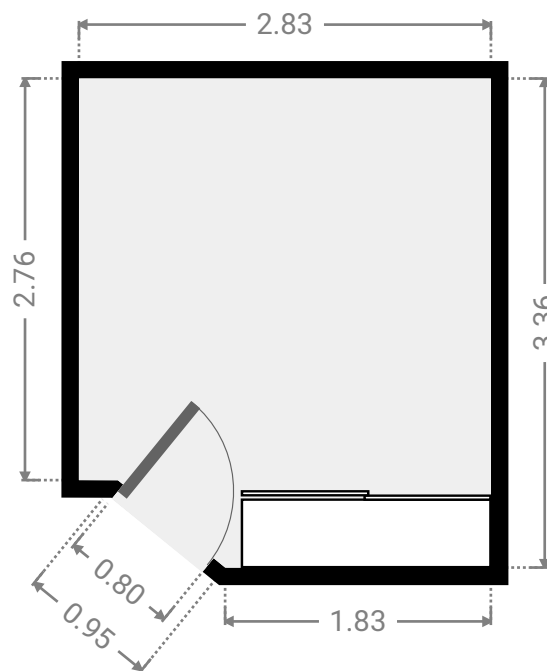
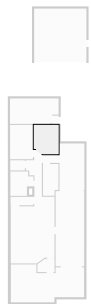

▼ Hall Ground Floor

WIDTH: 1.80 m • LENGTH: 0.88 m
AREA: 1.58 m² • PERIMETER: 5.36 m

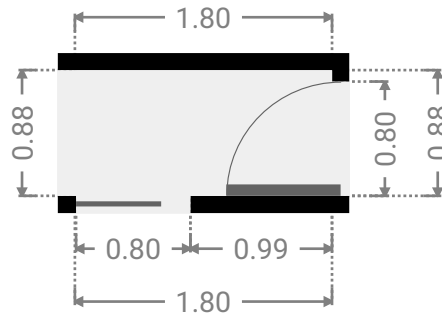

▼ Laundry Room Ground Floor

WIDTH: 1.78 m • LENGTH: 3.65 m
AREA: 6.22 m² • PERIMETER: 10.87 m

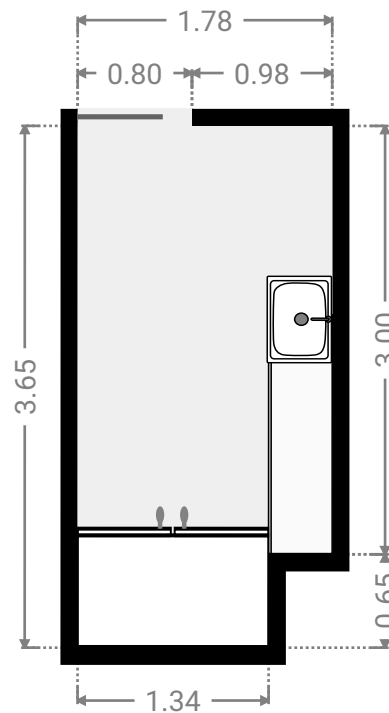

▼ Garage Ground Floor

WIDTH: 6.00 m • LENGTH: 6.00 m
AREA: 36.00 m² • PERIMETER: 24.00 m

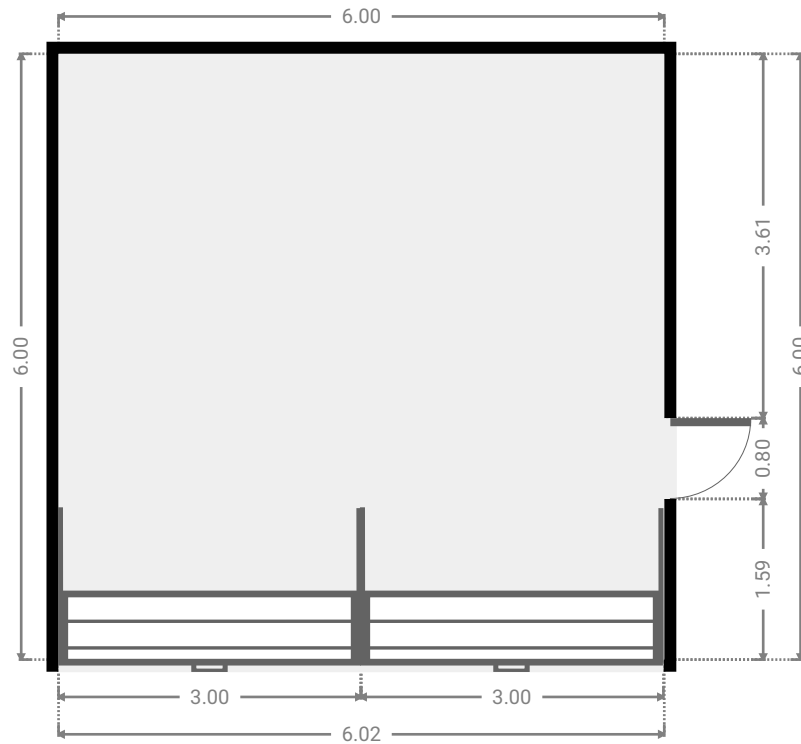

▼ Living Room Ground Floor

WIDTH: 5.58 m • LENGTH: 2.92 m
AREA: 16.08 m² • PERIMETER: 20.25 m

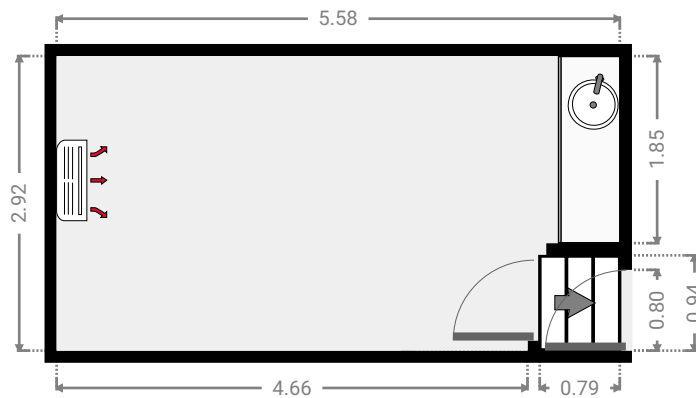

▼ Other Ground Floor

WIDTH: 8.42 m • LENGTH: 4.35 m
AREA: 31.30 m² • PERIMETER: 26.86 m

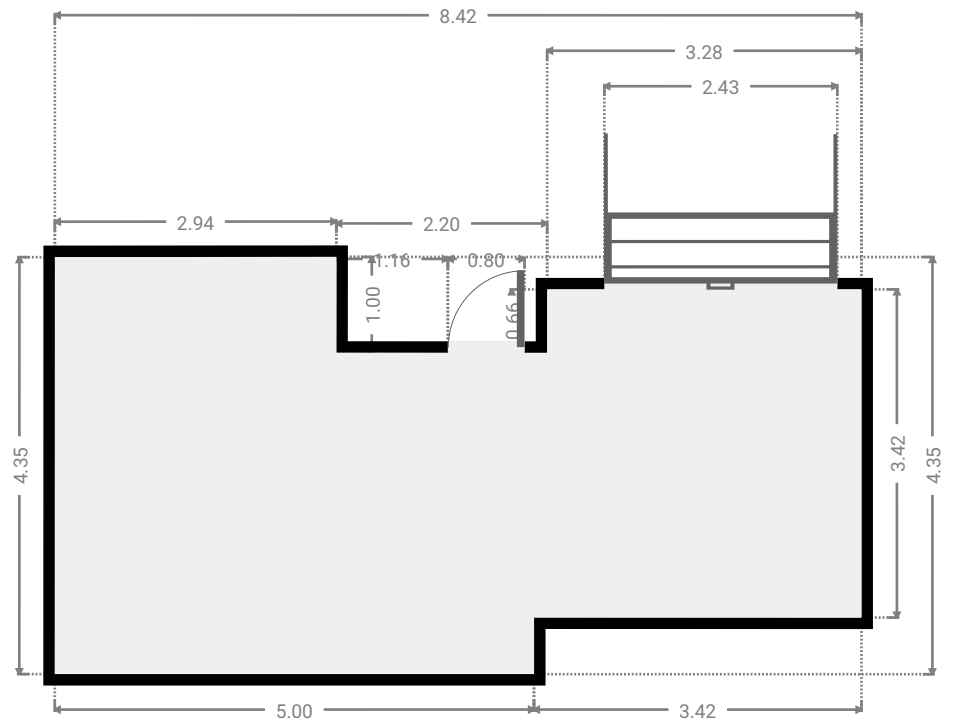

▼ 1st Floor

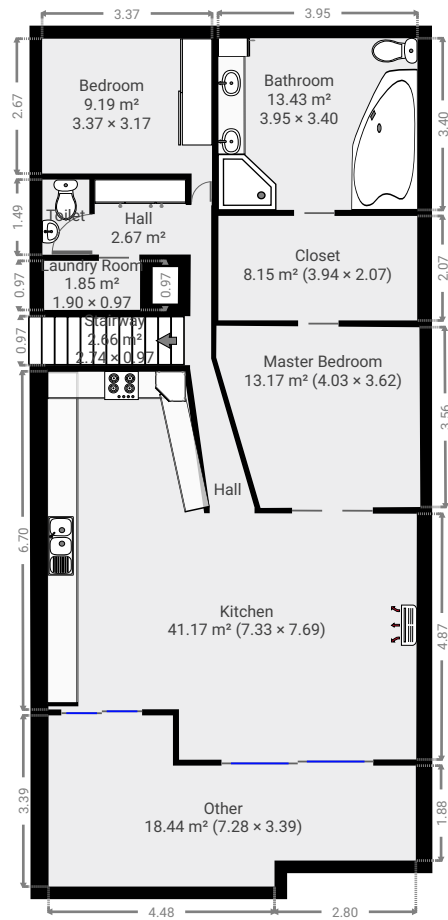

▼ Bedroom 1st Floor

WIDTH: 3.91 m • LENGTH: 3.17 m
AREA: 9.19 m² • PERIMETER: 13.07 m

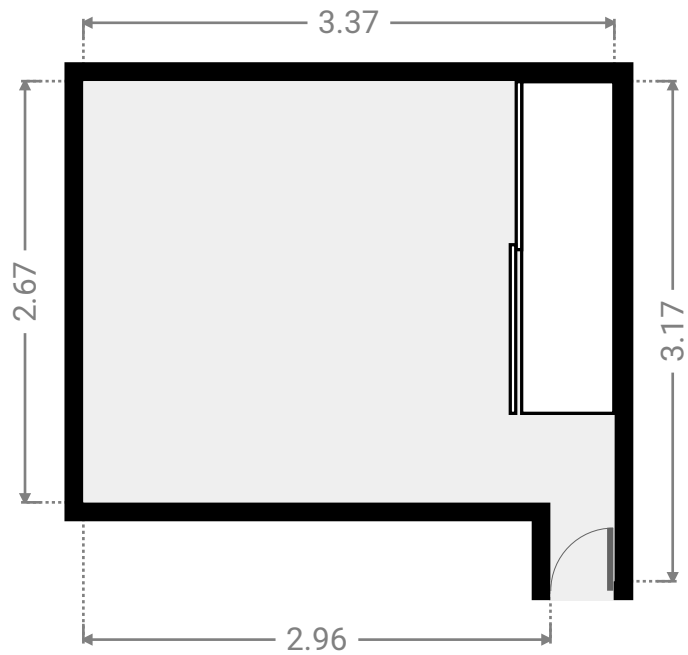
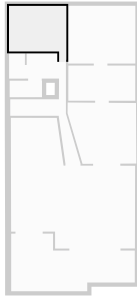

▼ Hall 1st Floor

WIDTH: 1.81 m • LENGTH: 1.48 m
AREA: 2.67 m² • PERIMETER: 6.57 m

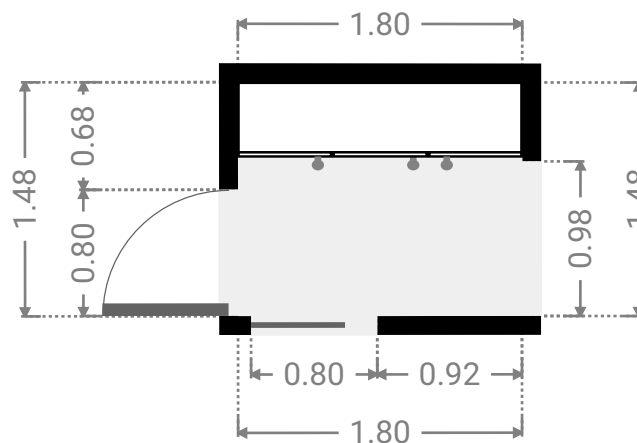
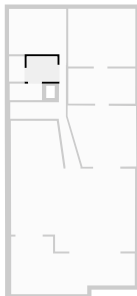

▼ Toilet 1st Floor

WIDTH: 0.93 m • LENGTH: 1.48 m
AREA: 1.38 m² • PERIMETER: 4.83 m

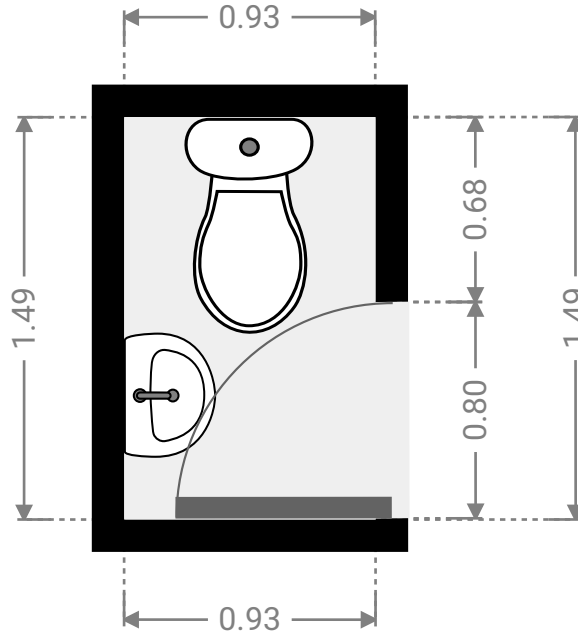
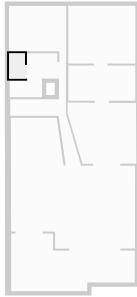

▼ Laundry Room 1st Floor

WIDTH: 1.90 m • LENGTH: 0.97 m
AREA: 1.85 m² • PERIMETER: 5.74 m

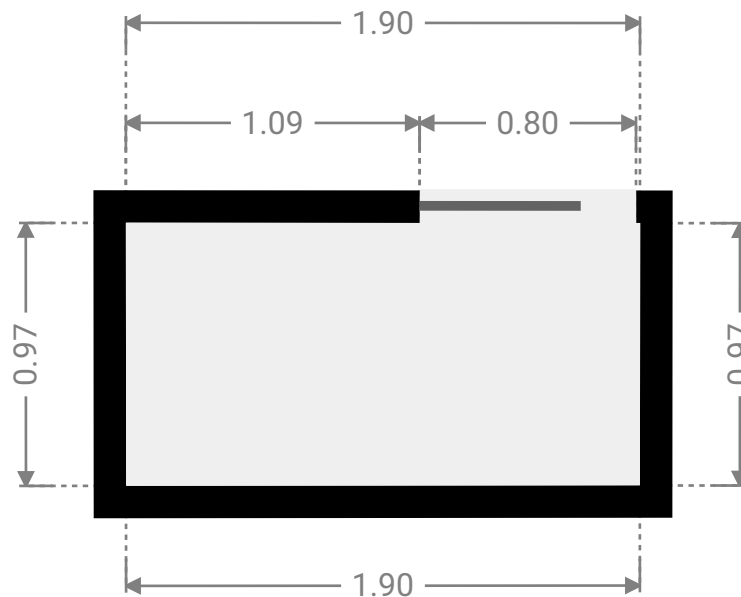
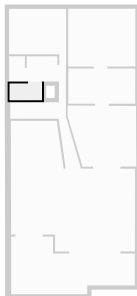

▼ Stairway 1st Floor

WIDTH: 2.96 m • LENGTH: 0.97 m
AREA: 2.66 m² • PERIMETER: 7.42 m

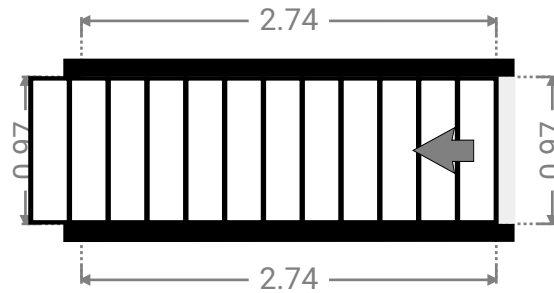
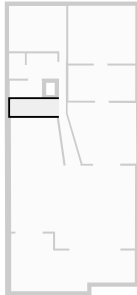

▼ Bathroom 1st Floor

WIDTH: 3.95 m • LENGTH: 3.40 m
AREA: 13.43 m² • PERIMETER: 14.70 m

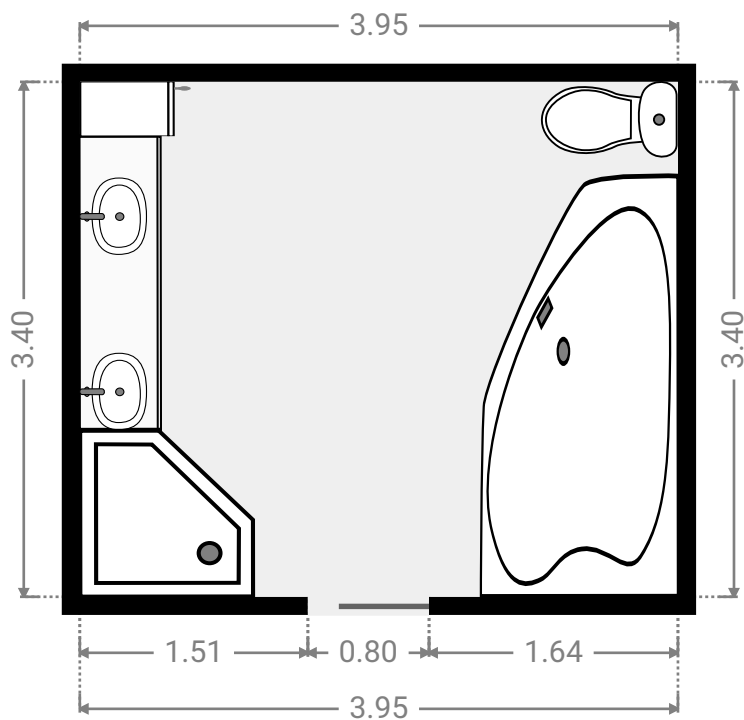
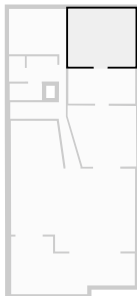

▼ **Closet**
1st Floor

WIDTH: 3.94 m • LENGTH: 2.07 m
AREA: 8.15 m² • PERIMETER: 12.02 m

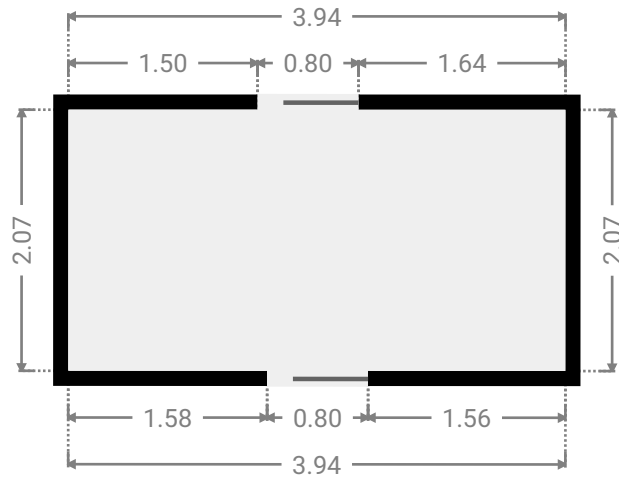
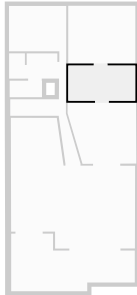

▼ **Master Bedroom**
1st Floor

WIDTH: 4.09 m • LENGTH: 3.60 m
AREA: 13.17 m² • PERIMETER: 14.49 m

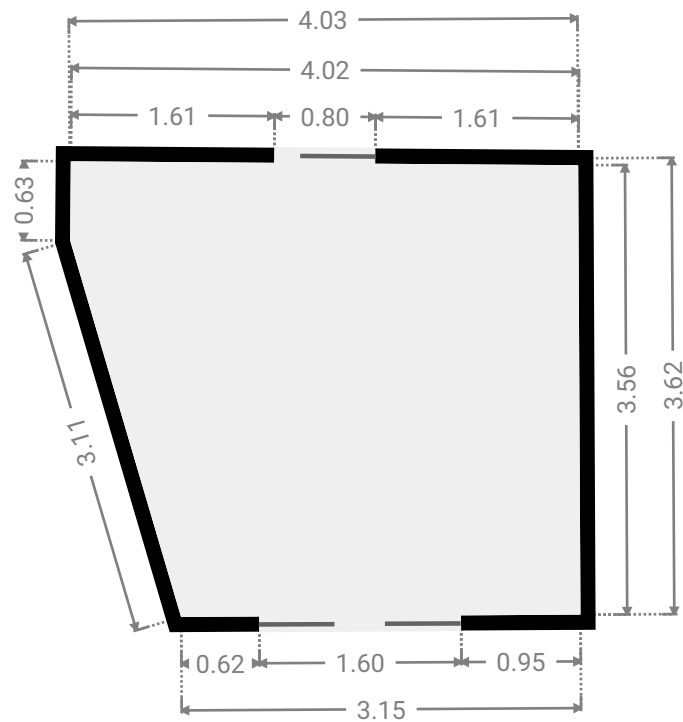
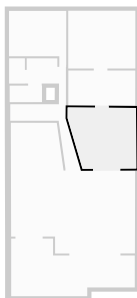

▼ **Hall**
1st Floor

WIDTH: 1.79 m • LENGTH: 6.01 m
AREA: 3.21 m² • PERIMETER: 13.43 m

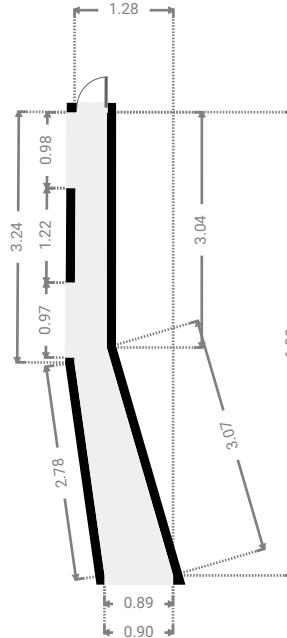
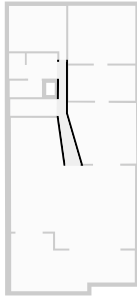

▼ **Kitchen**
1st Floor

WIDTH: 7.33 m • LENGTH: 7.69 m
AREA: 41.17 m² • PERIMETER: 29.61 m

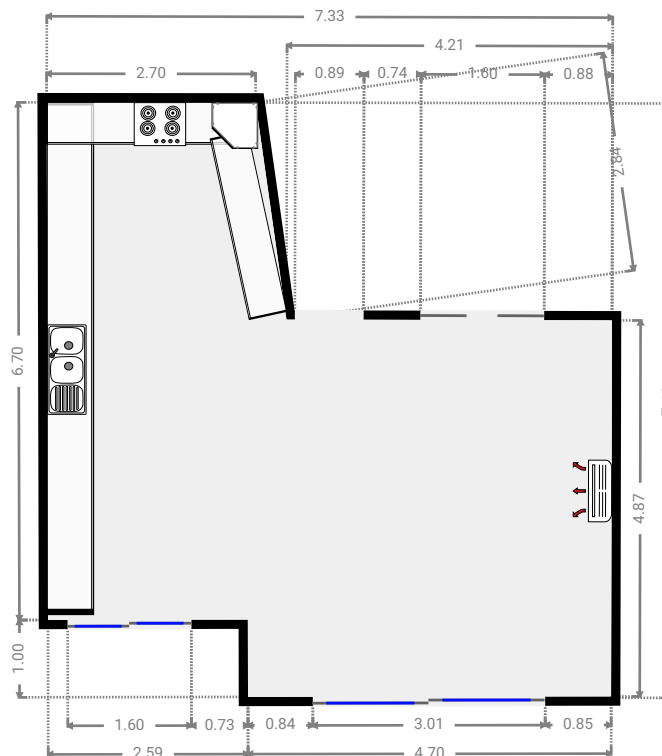
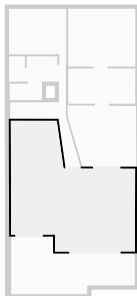

▼ Other
1st Floor

WIDTH: 7.28 m • LENGTH: 3.39 m
AREA: 18.44 m² • PERIMETER: 21.33 m

