

16 Constantia Crescent

SUBMITTED BY

Ray White Rockhampton Casey
stockers@cqoz.com

CREATED ON

2018-04-06

Floors

1

FLOORS: 1

▼ Ground Floor

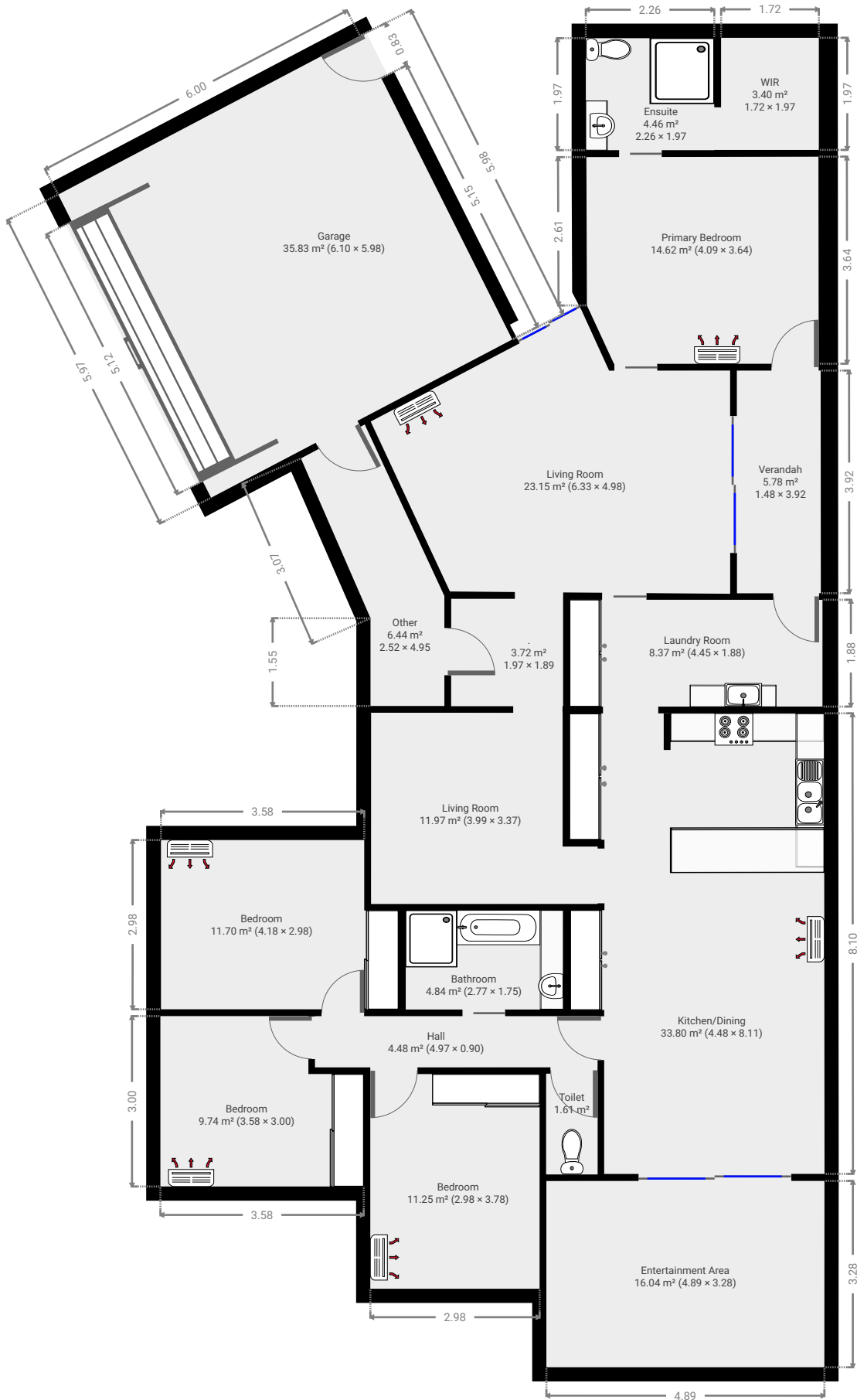

THIS FLOORPLAN IS PROVIDED WITHOUT WARRANTY OF ANY KIND. SENSOPIA DISCLAIMS ANY WARRANTY INCLUDING, WITHOUT LIMITATION, SATISFACTORY QUALITY OR ACCURACY OF DIMENSIONS.



FLOORS: 1

▼ **Ground Floor**

WIDTH: 1.89 m • LENGTH: 1.97 m
 AREA: 3.72 m² • PERIMETER: 7.72 m

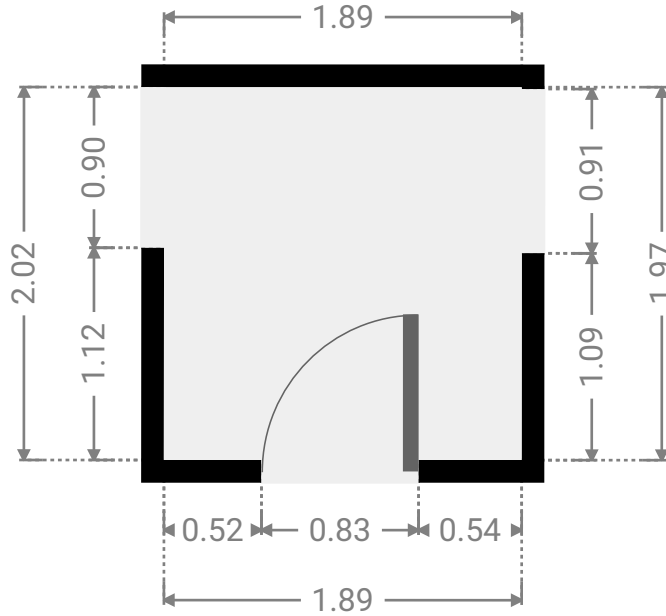
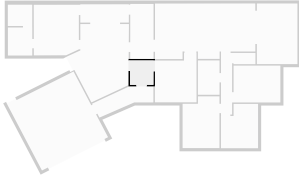

▼ **Bathroom**
 Ground Floor

WIDTH: 1.75 m • LENGTH: 2.77 m
 AREA: 4.84 m² • PERIMETER: 9.04 m

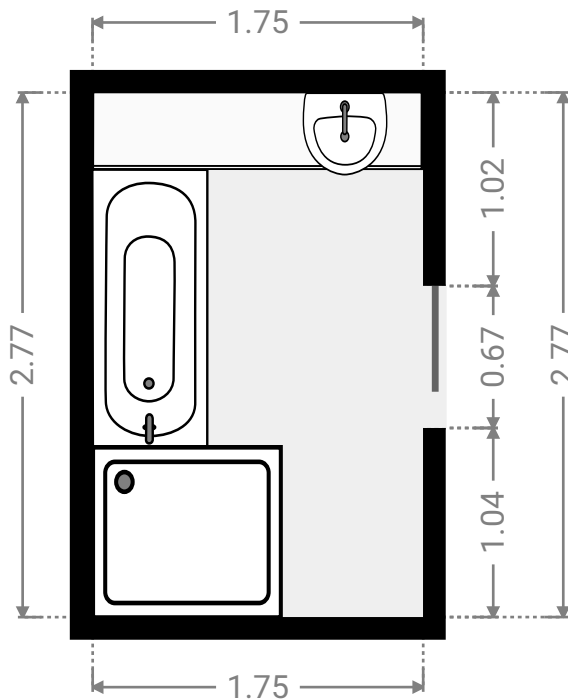
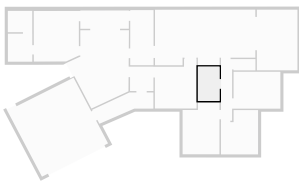

FLOORS: 1

▼ Bedroom Ground Floor

WIDTH: 3.78 m • LENGTH: 2.98 m
AREA: 11.25 m² • PERIMETER: 13.51 m

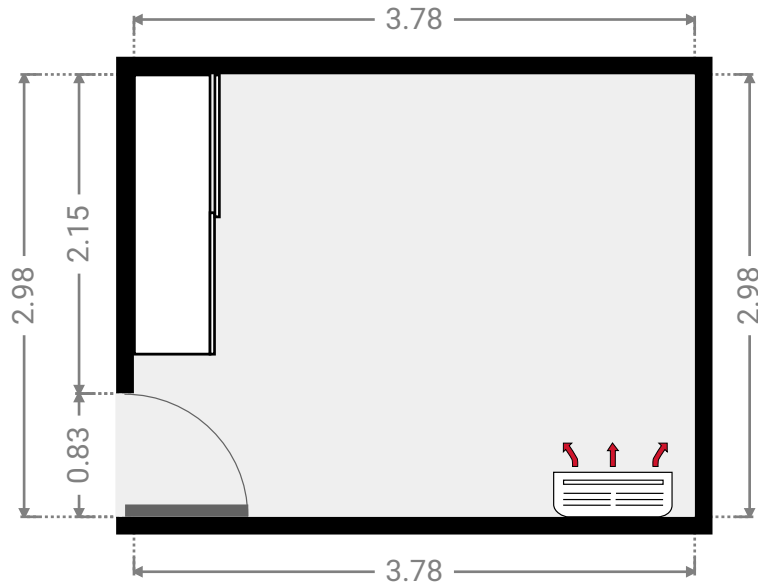
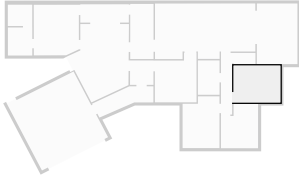

▼ Bedroom Ground Floor

WIDTH: 3.00 m • LENGTH: 3.58 m
AREA: 9.74 m² • PERIMETER: 13.15 m

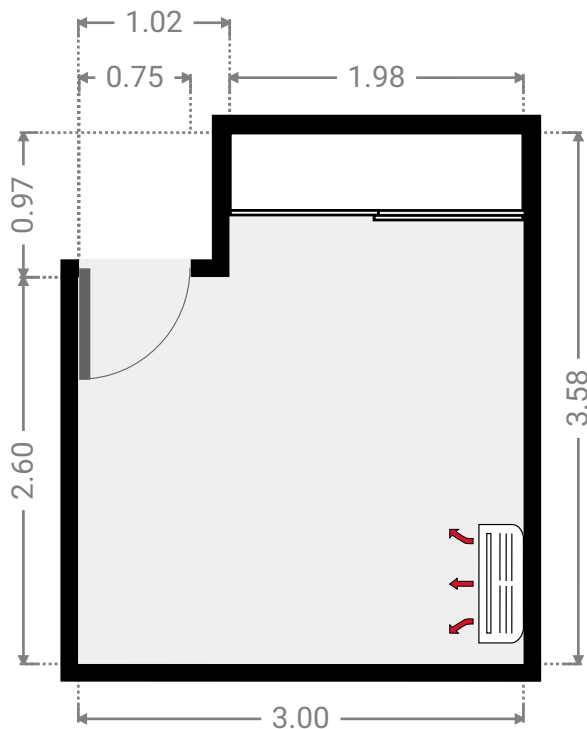
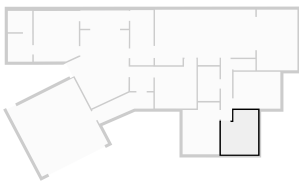

FLOORS: 1

▼ Bedroom Ground Floor

WIDTH: 2.98 m • LENGTH: 4.18 m
AREA: 11.70 m² • PERIMETER: 14.32 m

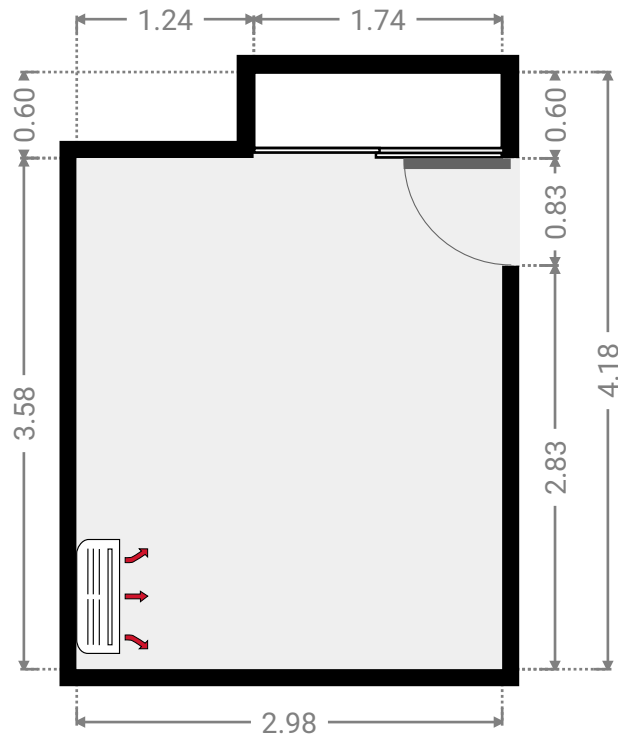
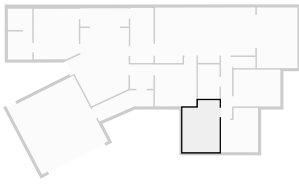

▼ Ensuite Ground Floor

WIDTH: 1.97 m • LENGTH: 2.26 m
AREA: 4.46 m² • PERIMETER: 8.46 m

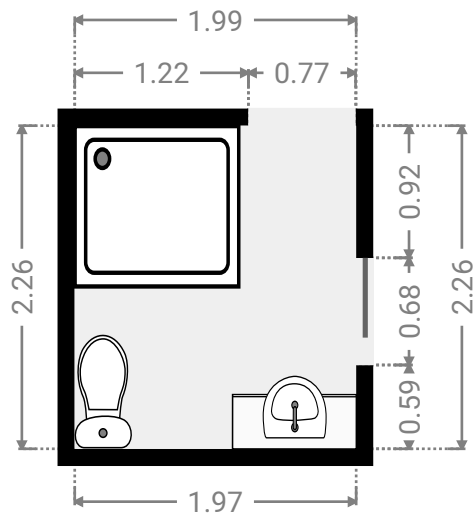
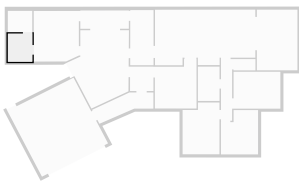

FLOORS: 1

▼ WIR Ground Floor

WIDTH: 1.97 m • LENGTH: 1.72 m
AREA: 3.40 m² • PERIMETER: 7.39 m

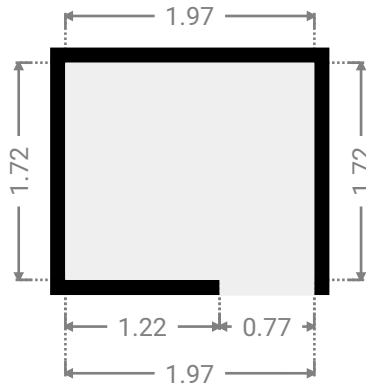
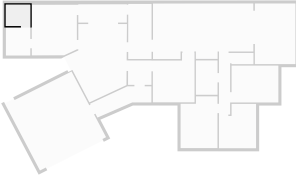

▼ Entertainment Area Ground Floor

WIDTH: 3.28 m • LENGTH: 4.89 m
AREA: 16.04 m² • PERIMETER: 16.34 m

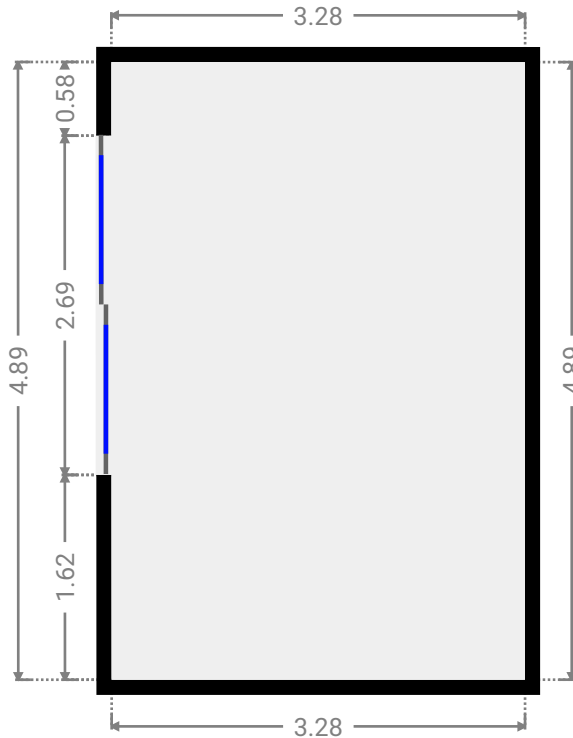
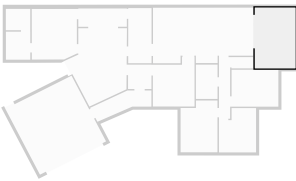

FLOORS: 1

▼ Garage Ground Floor

WIDTH: 5.97 m • LENGTH: 6.10 m
AREA: 35.83 m² • PERIMETER: 23.94 m

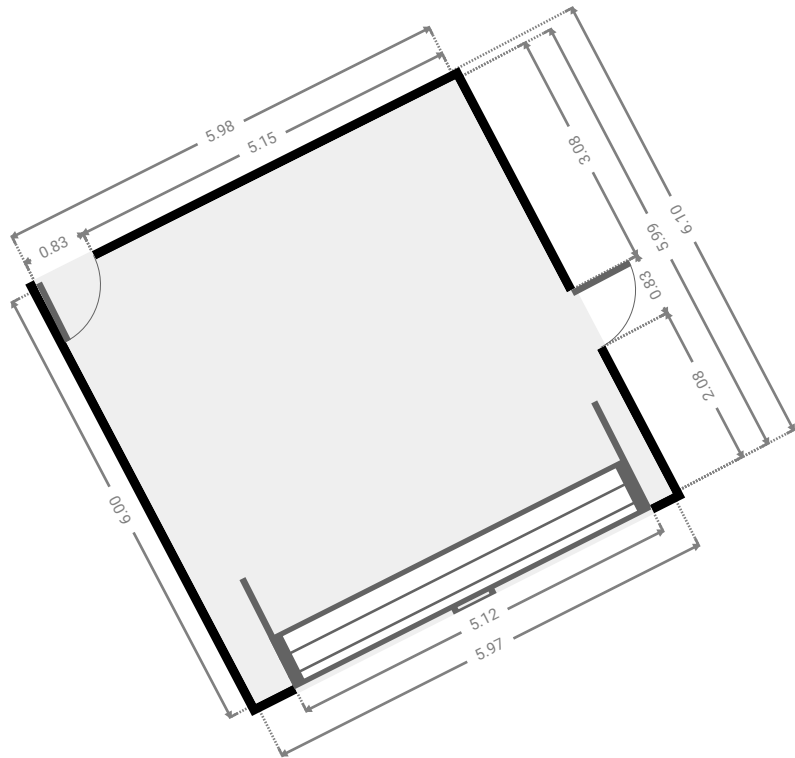
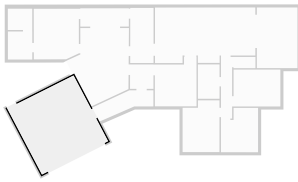

▼ Hall Ground Floor

WIDTH: 0.90 m • LENGTH: 4.97 m
AREA: 4.48 m² • PERIMETER: 11.75 m

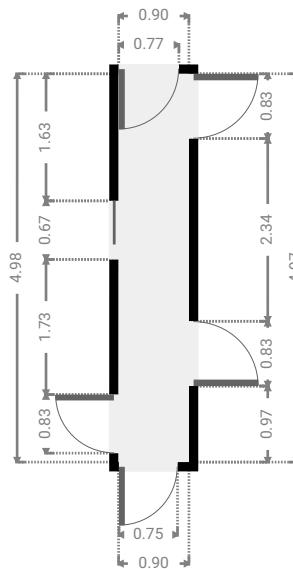
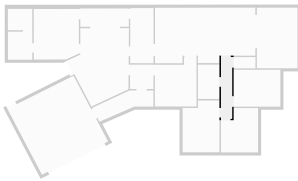

FLOORS: 1

▼ Kitchen/Dining Ground Floor

WIDTH: 8.11 m • LENGTH: 4.48 m
AREA: 33.80 m² • PERIMETER: 26.38 m

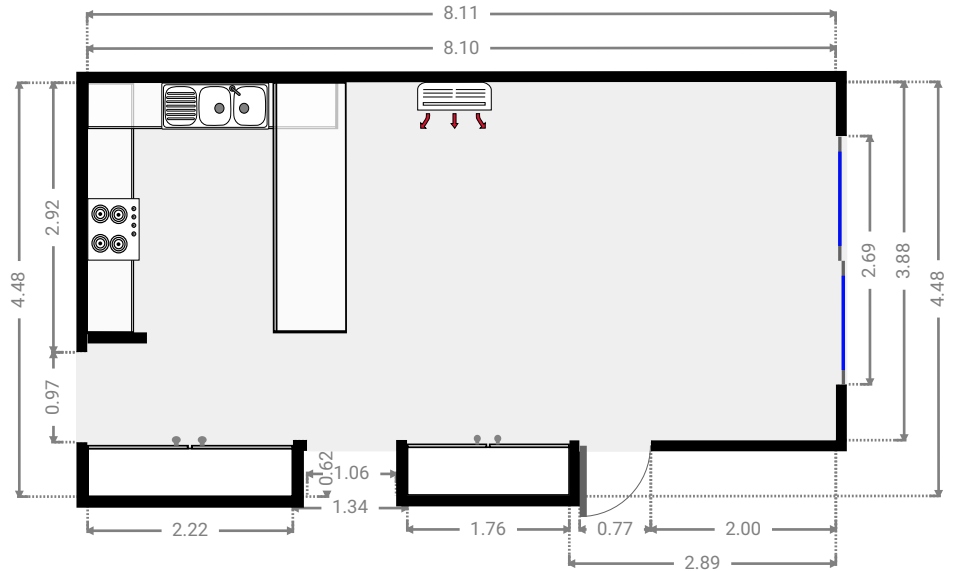
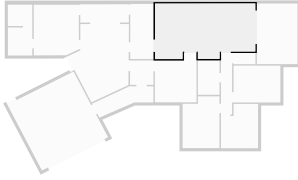

▼ Laundry Room Ground Floor

WIDTH: 1.88 m • LENGTH: 4.45 m
AREA: 8.37 m² • PERIMETER: 12.66 m

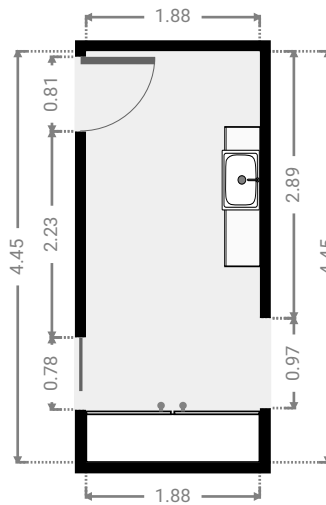
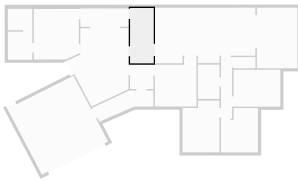

FLOORS: 1

▼ **Living Room**
Ground Floor

WIDTH: 4.98 m • LENGTH: 6.33 m
AREA: 23.15 m² • PERIMETER: 19.65 m

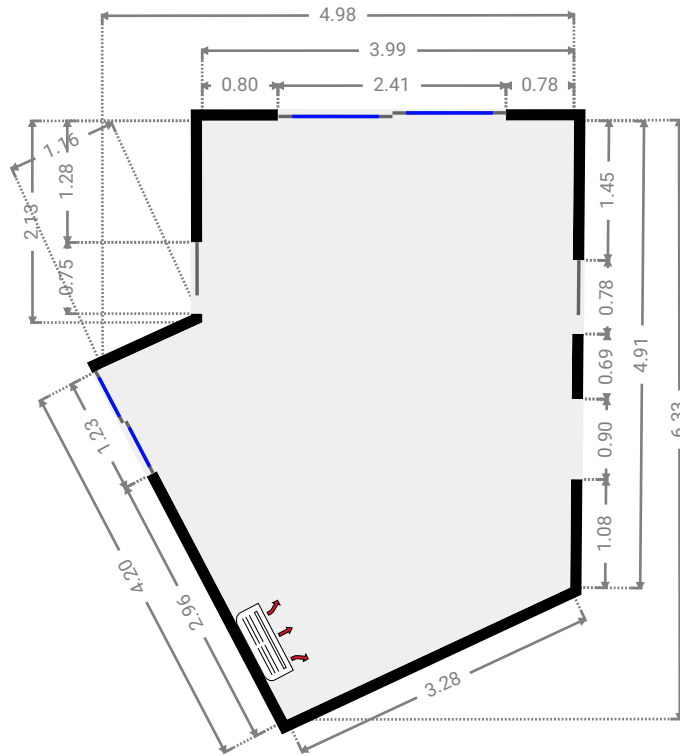
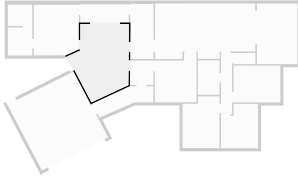

▼ **Living Room**
Ground Floor

WIDTH: 3.37 m • LENGTH: 3.99 m
AREA: 11.97 m² • PERIMETER: 14.70 m

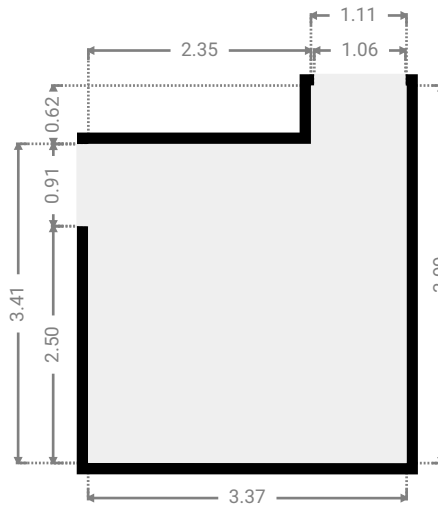
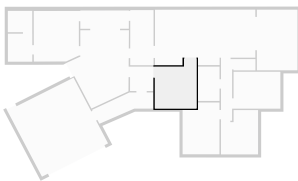

FLOORS: 1

▼ **Other**
Ground Floor

WIDTH: 4.95 m • LENGTH: 2.52 m
AREA: 6.44 m² • PERIMETER: 12.45 m

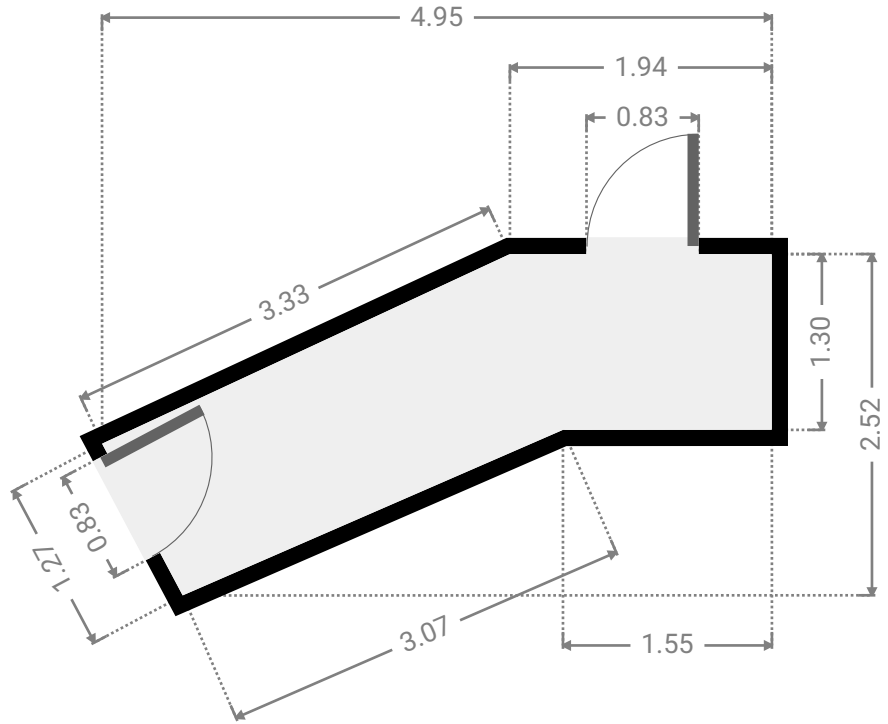
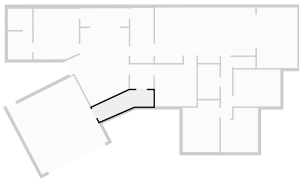

▼ **Primary Bedroom**
Ground Floor

WIDTH: 3.64 m • LENGTH: 4.09 m
AREA: 14.62 m² • PERIMETER: 15.08 m

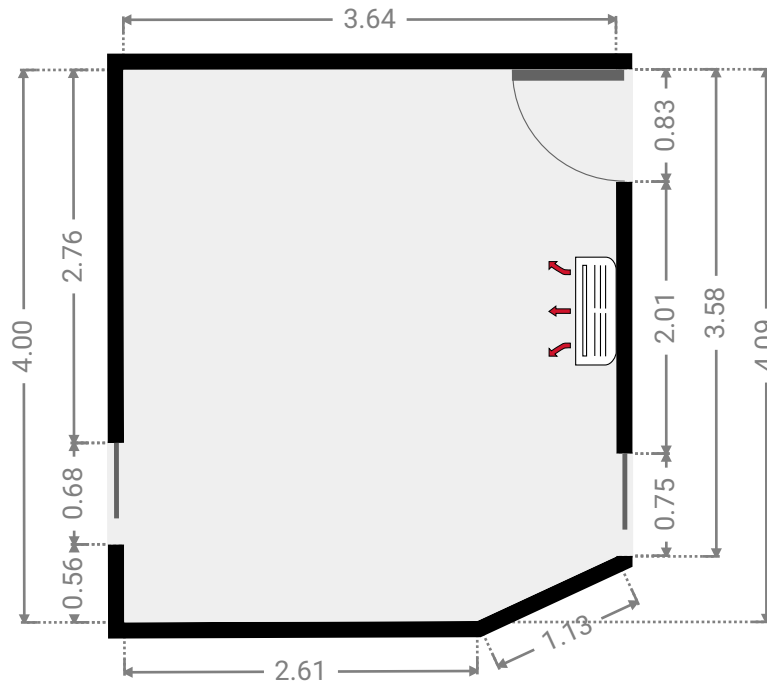
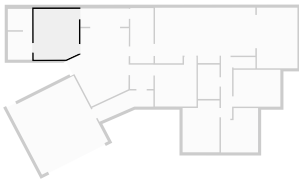

▼ Toilet Ground Floor

WIDTH: 1.77 m • LENGTH: 0.91 m
AREA: 1.61 m² • PERIMETER: 5.36 m

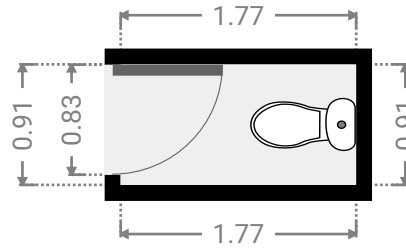
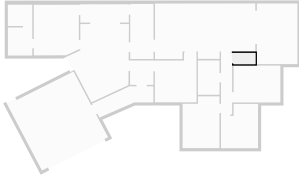

▼ Verandah Ground Floor

WIDTH: 3.92 m • LENGTH: 1.48 m
AREA: 5.78 m² • PERIMETER: 10.79 m

