

16/240 German Street

Created on
2020-08-25

Floors

1

▼ Ground Floor



▼ **Hall**
Ground Floor

WIDTH: 1.08 m • LENGTH: 2.96 m
AREA: 3.20 m² • PERIMETER: 8.08 m

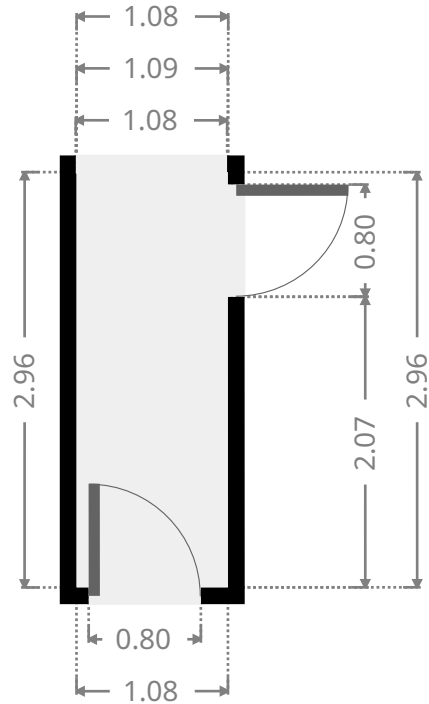
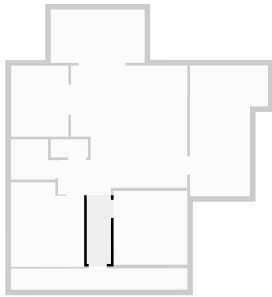

▼ **Bedroom**
Ground Floor

WIDTH: 3.32 m • LENGTH: 3.32 m
AREA: 11.02 m² • PERIMETER: 13.28 m

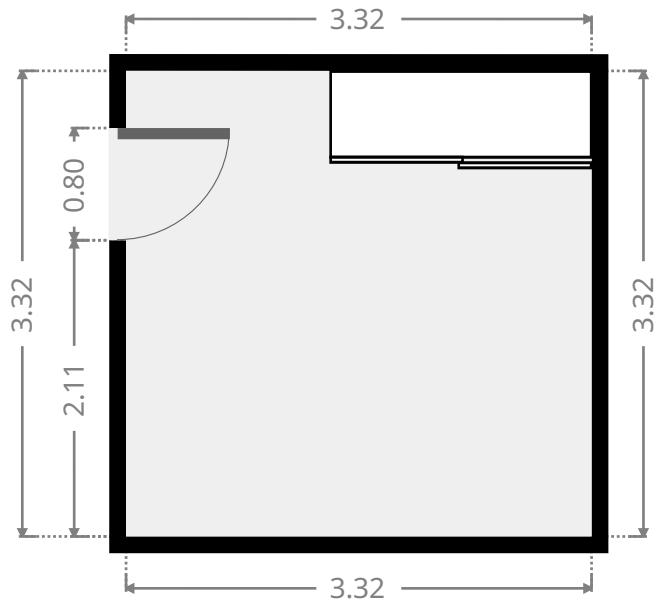
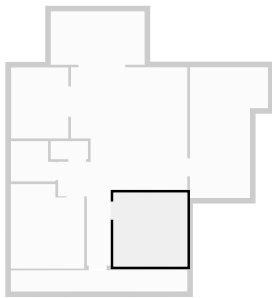

▼ **Living Room**
Ground Floor

WIDTH: 5.81 m • **LENGTH:** 5.80 m
AREA: 29.27 m² • **PERIMETER:** 24.98 m

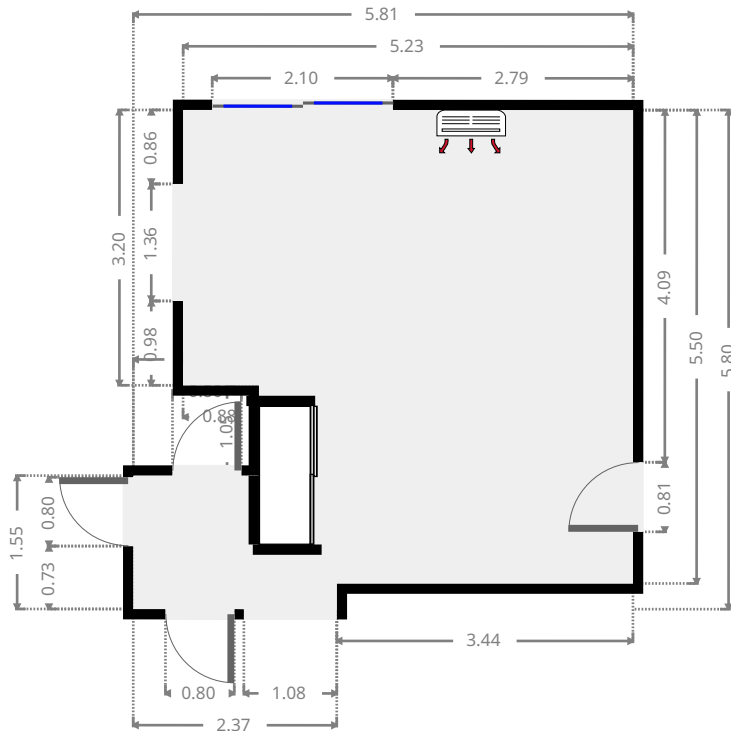
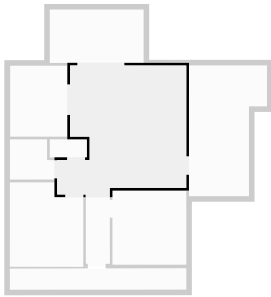

▼ **Bedroom**
Ground Floor

WIDTH: 3.30 m • **LENGTH:** 3.80 m
AREA: 11.75 m² • **PERIMETER:** 14.20 m

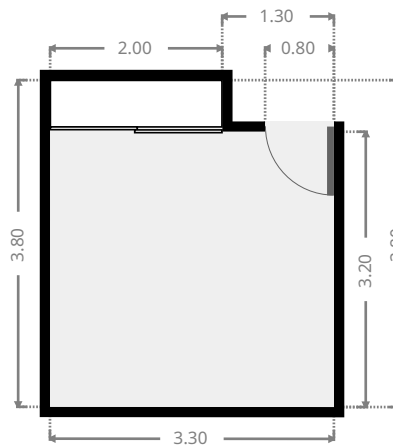
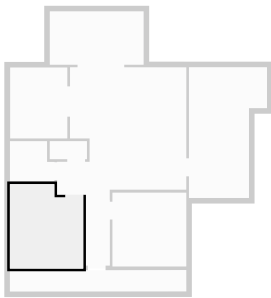

FLOORS: 1

▼ **Toilet**
Ground Floor

WIDTH: 1.67 m • LENGTH: 0.81 m
AREA: 1.36 m² • PERIMETER: 4.97 m

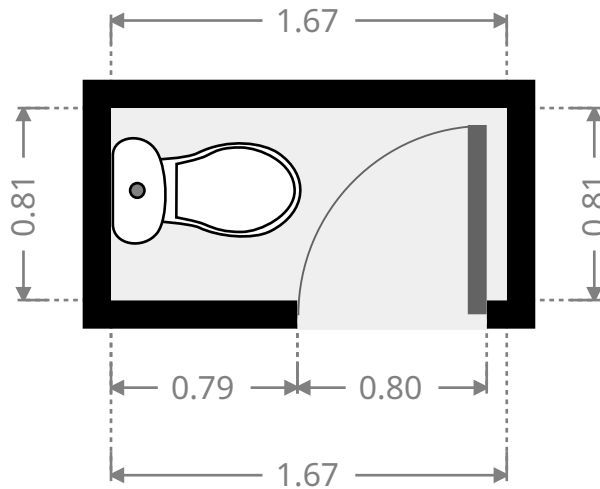
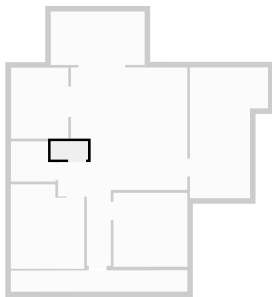

▼ **Bathroom**
Ground Floor

WIDTH: 2.00 m • LENGTH: 1.81 m
AREA: 3.31 m² • PERIMETER: 7.62 m

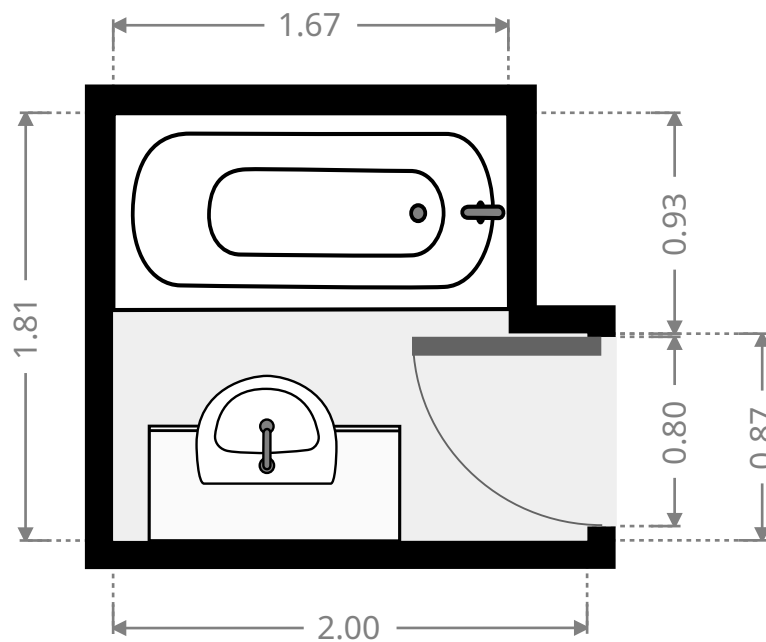
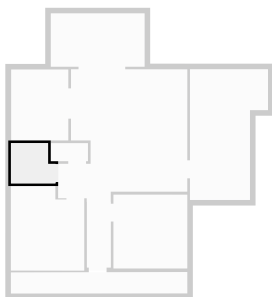

FLOORS: 1

▼ **Living Room**
Ground Floor

WIDTH: 2.57 m • LENGTH: 3.19 m
AREA: 8.20 m² • PERIMETER: 11.52 m

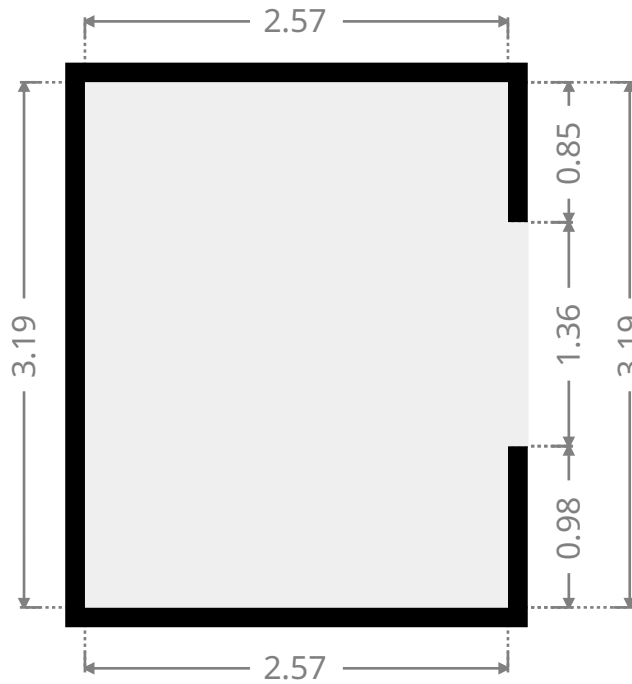
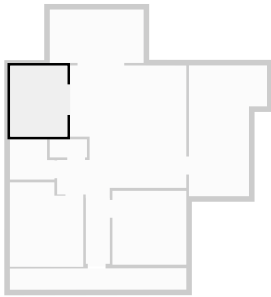

▼ **Other**
Ground Floor

WIDTH: 4.22 m • LENGTH: 2.40 m
AREA: 10.13 m² • PERIMETER: 13.24 m

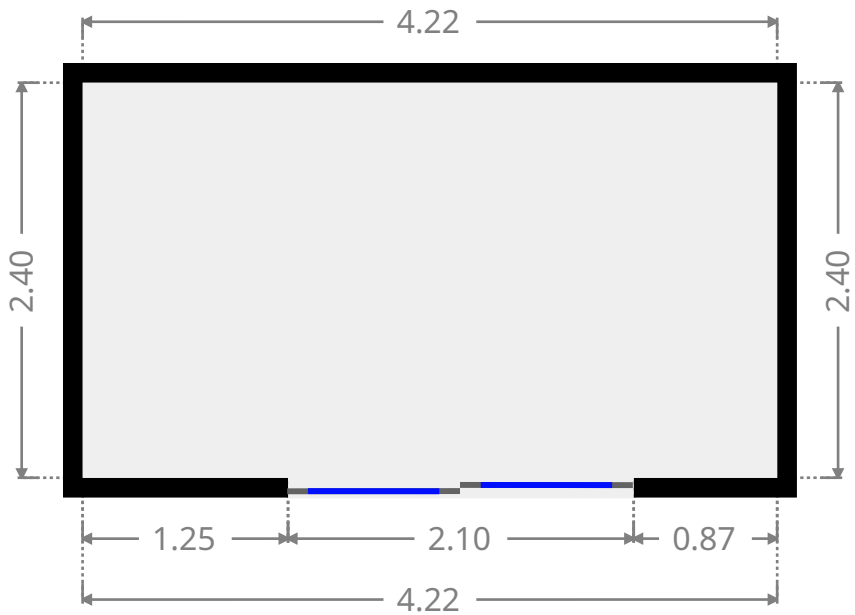
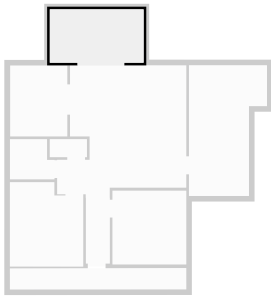

FLOORS: 1

▼ **Garage**
Ground Floor

WIDTH: 3.51 m • LENGTH: 5.88 m
AREA: 17.37 m² • PERIMETER: 18.78 m

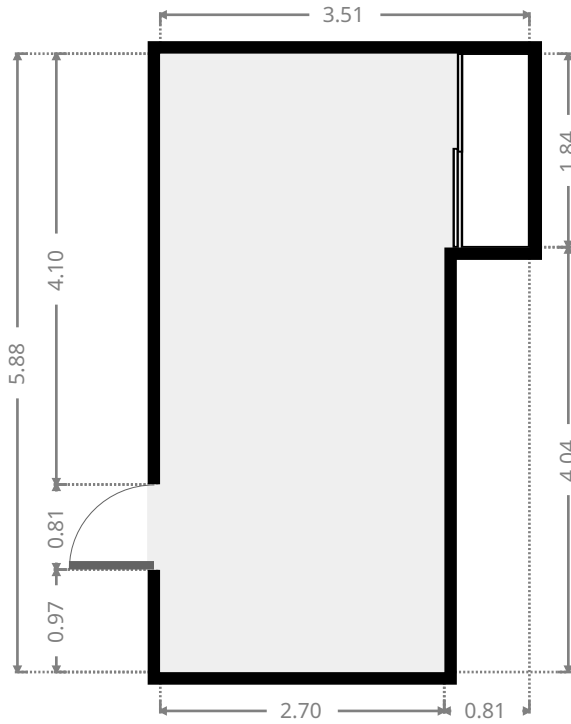
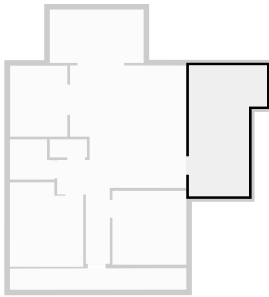

▼ **Other**
Ground Floor

WIDTH: 7.93 m • LENGTH: 0.96 m
AREA: 7.59 m² • PERIMETER: 17.78 m

