

157 Hyde Street

Ground Floor

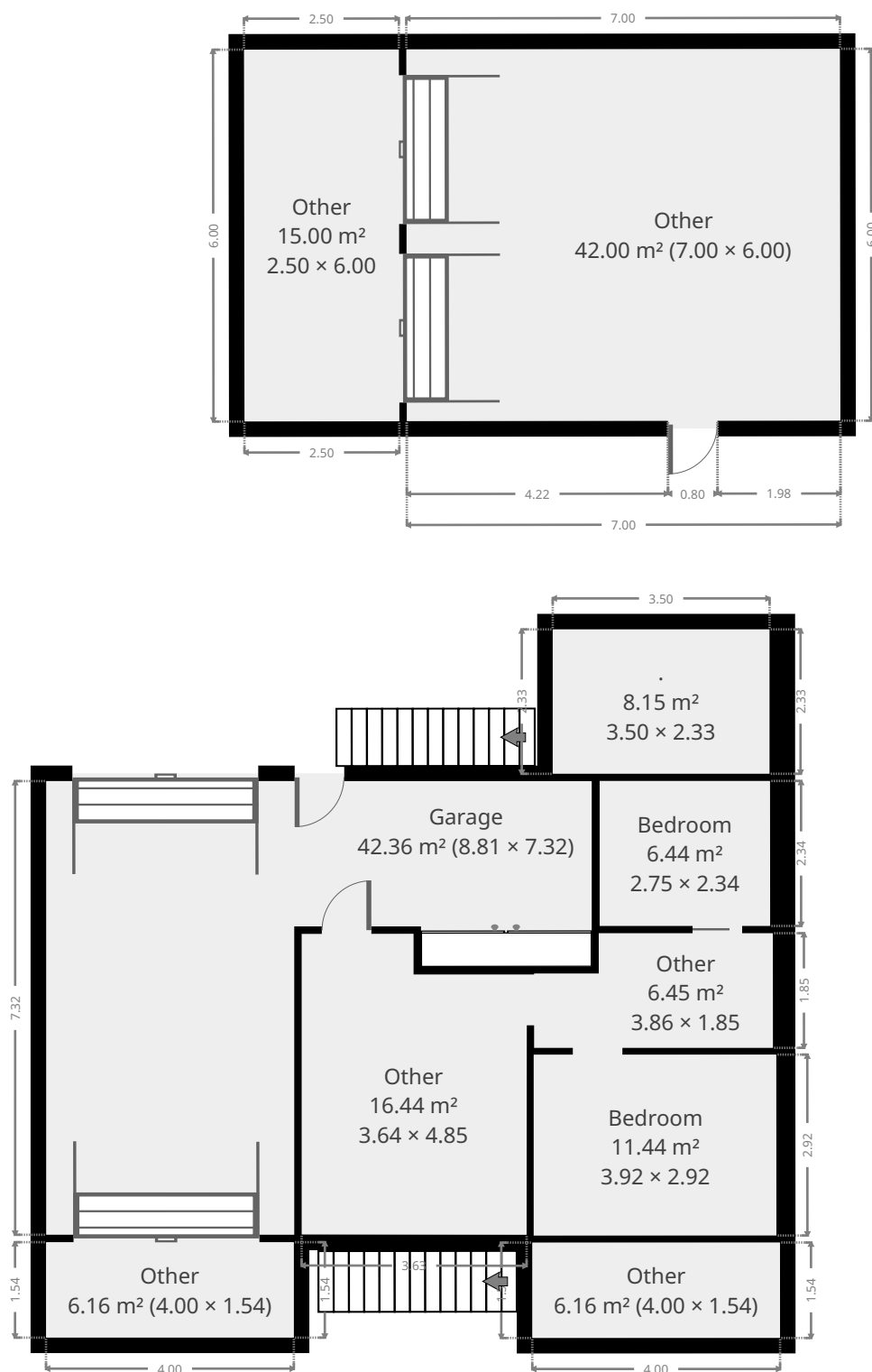

THIS FLOORPLAN IS PROVIDED WITHOUT WARRANTY OF ANY KIND. SENSOPIA DISCLAIMS ANY WARRANTY INCLUDING, WITHOUT LIMITATION, SATISFACTORY QUALITY OR ACCURACY OF DIMENSIONS.

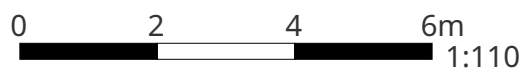

157 Hyde Street

Garage

Width: 7.32 m
 Length: 8.81 m
 Area: 42.36 m²
 Perimeter: 33.55 m

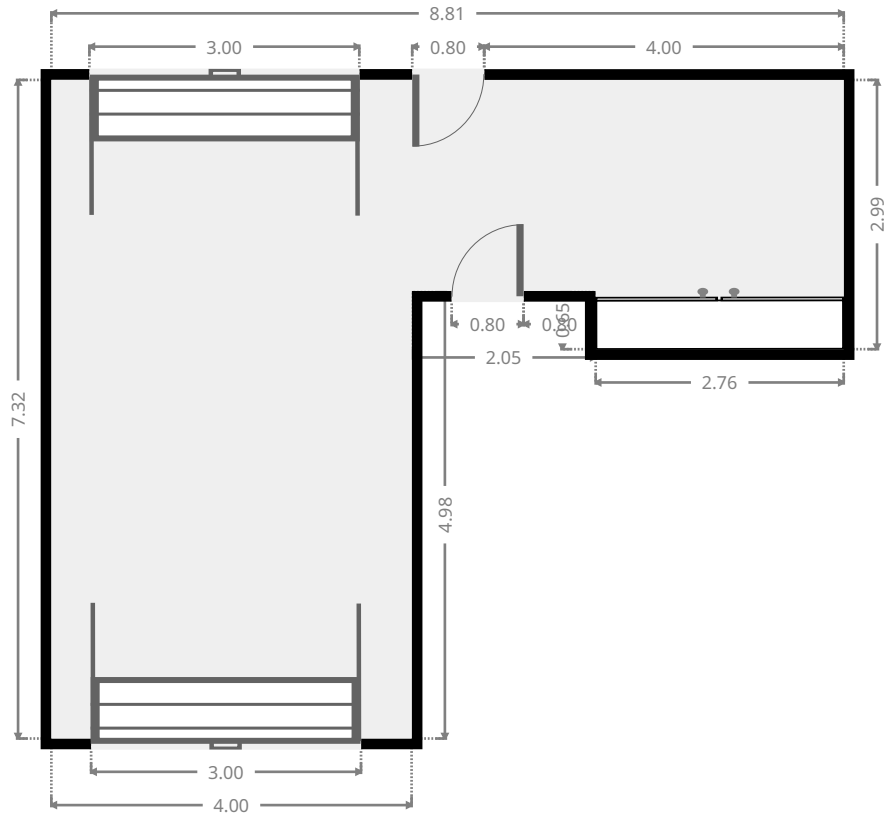
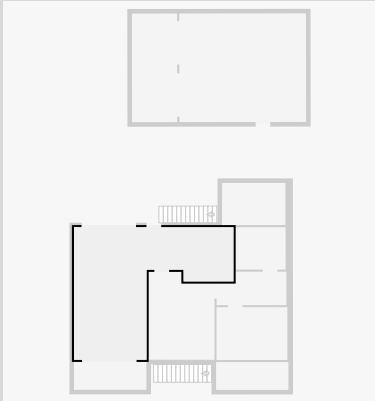

Other

Width: 3.64 m
 Length: 4.85 m
 Area: 16.44 m²
 Perimeter: 16.98 m

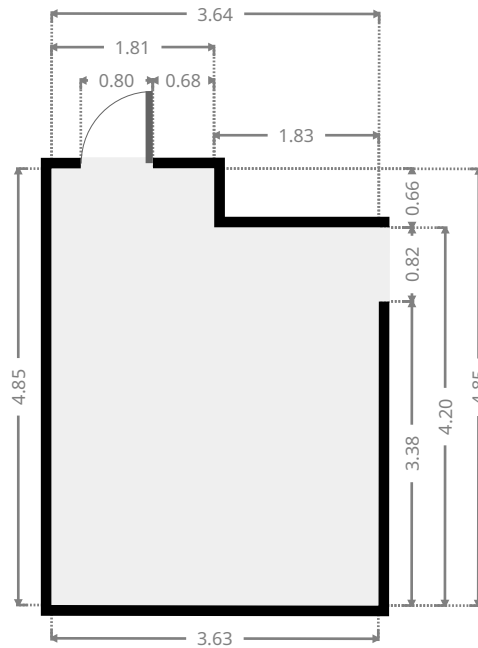
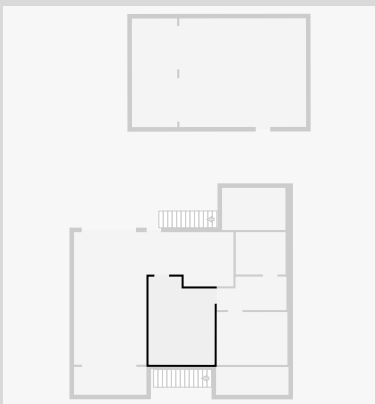

157 Hyde Street

Other

Width: 1.85 m
Length: 3.86 m
Area: 6.45 m²
Perimeter: 11.41 m

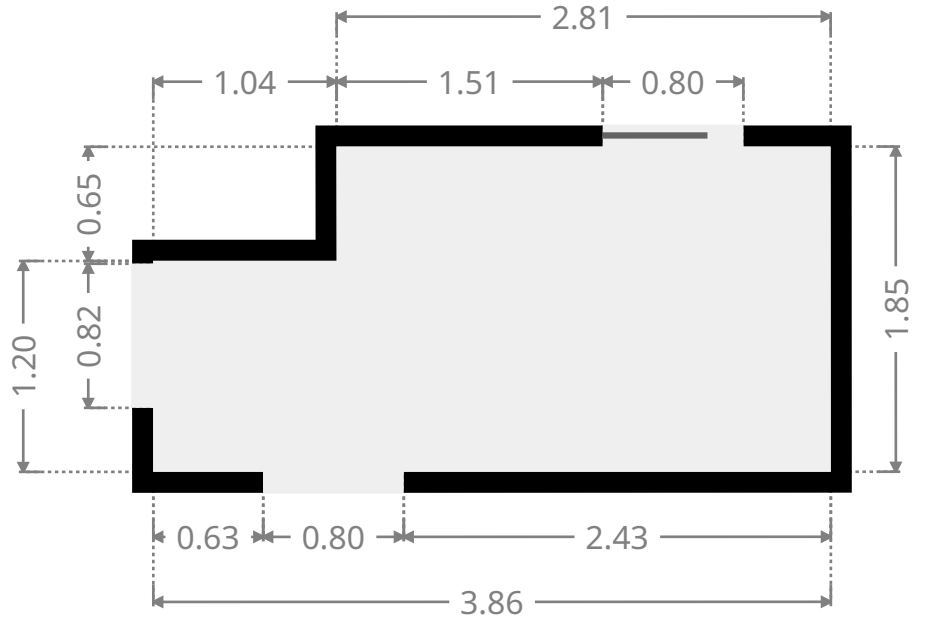
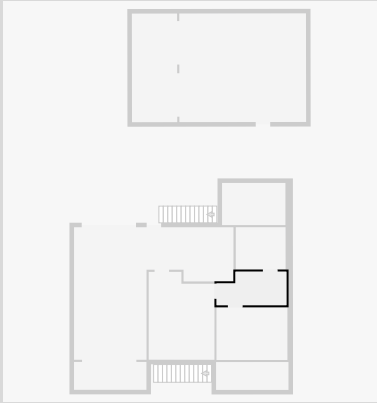

Bedroom

Width: 2.92 m
Length: 3.92 m
Area: 11.44 m²
Perimeter: 13.67 m

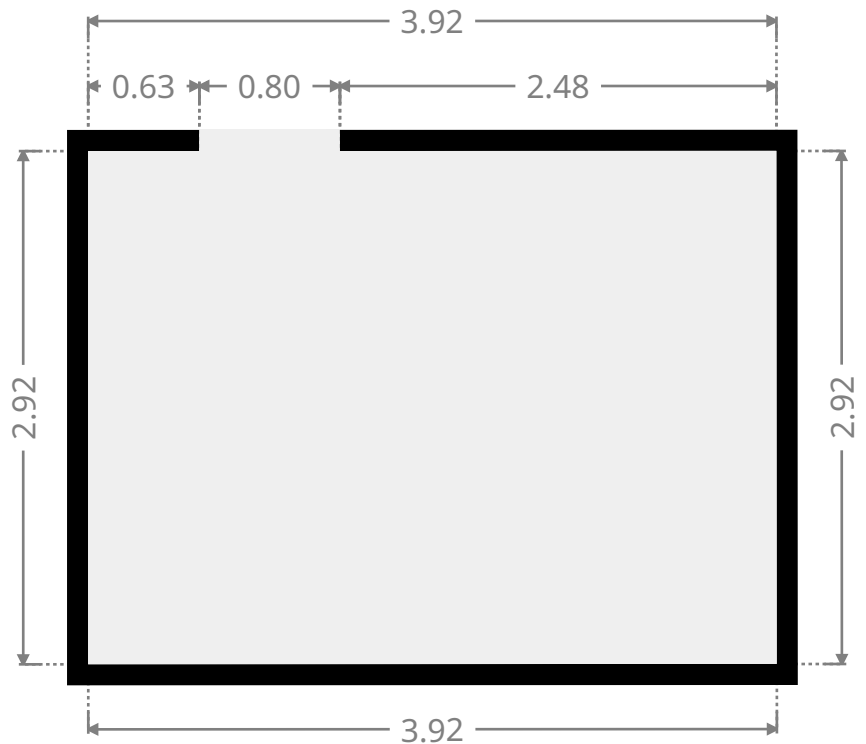
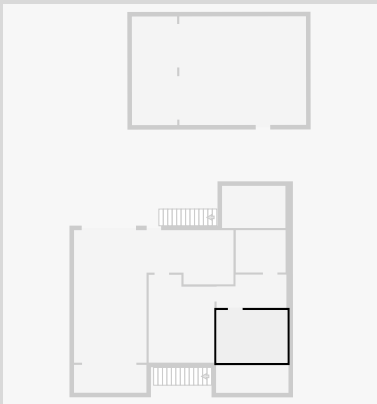

THIS FLOORPLAN IS PROVIDED WITHOUT WARRANTY OF ANY KIND. SENSOPIA DISCLAIMS ANY WARRANTY INCLUDING, WITHOUT LIMITATION, SATISFACTORY QUALITY OR ACCURACY OF DIMENSIONS.

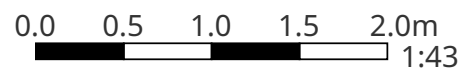

157 Hyde Street

Bedroom

Width: 2.34 m
Length: 2.75 m
Area: 6.44 m²
Perimeter: 10.18 m

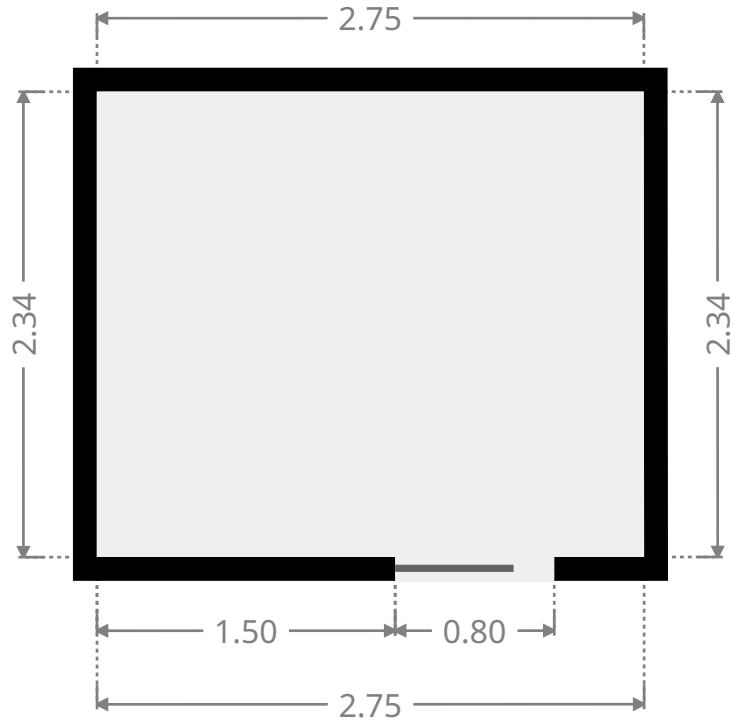
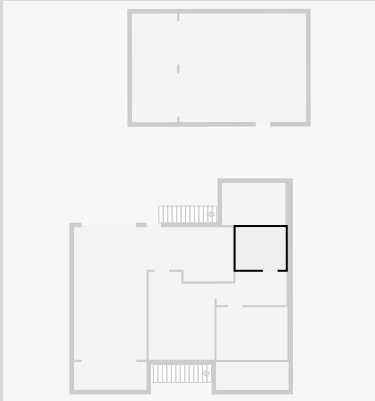

Width: 2.33 m
Length: 3.50 m
Area: 8.15 m²
Perimeter: 11.66 m

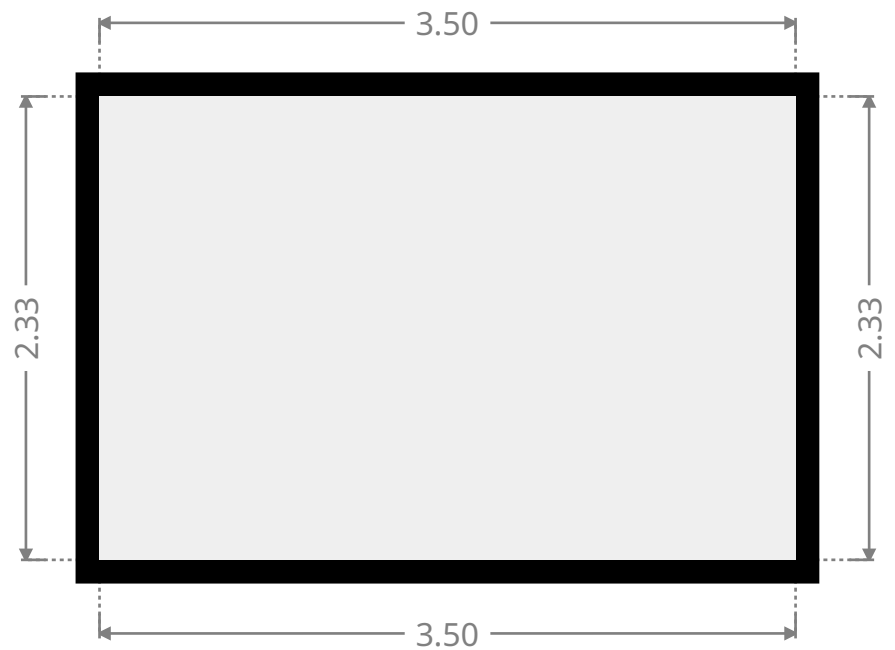
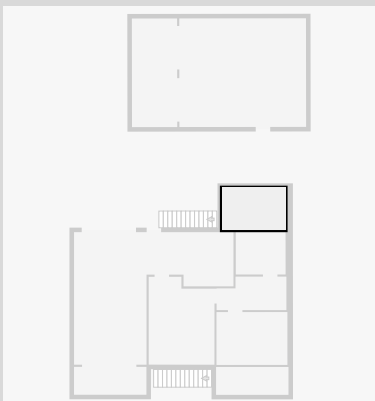

157 Hyde Street

Other

Width: 2.50 m
 Length: 6.00 m
 Area: 15.00 m²
 Perimeter: 17.00 m

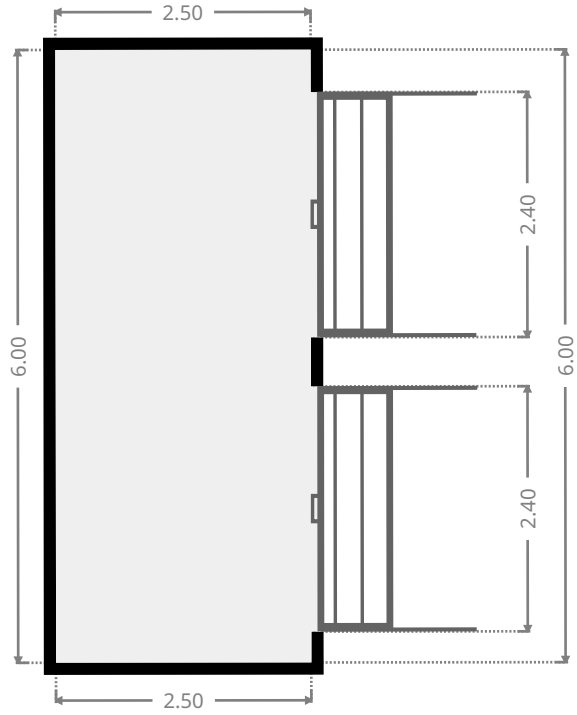
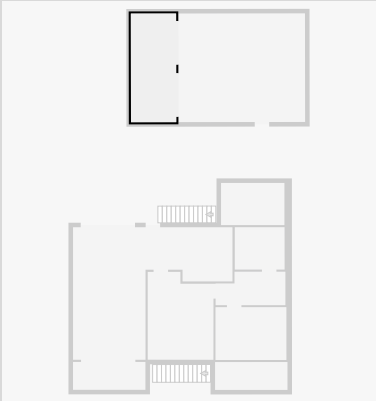

Other

Width: 6.00 m
 Length: 7.00 m
 Area: 42.00 m²
 Perimeter: 26.00 m

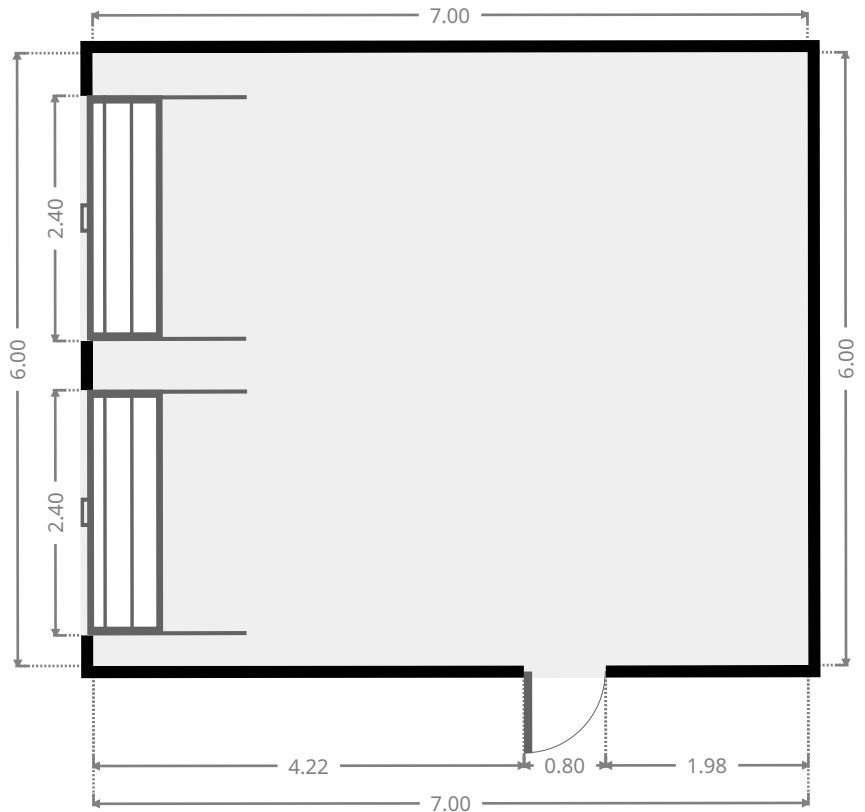
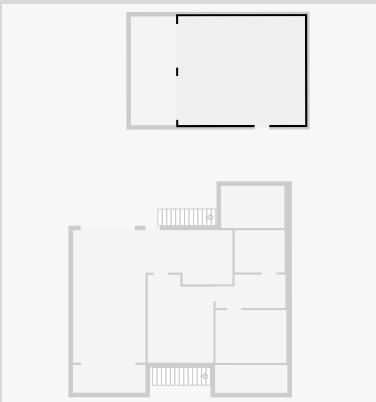

THIS FLOORPLAN IS PROVIDED WITHOUT WARRANTY OF ANY KIND. SENSOPIA DISCLAIMS ANY WARRANTY INCLUDING, WITHOUT LIMITATION, SATISFACTORY QUALITY OR ACCURACY OF DIMENSIONS.

157 Hyde Street

Other

Width: 1.54 m
 Length: 4.00 m
 Area: 6.16 m²
 Perimeter: 11.08 m

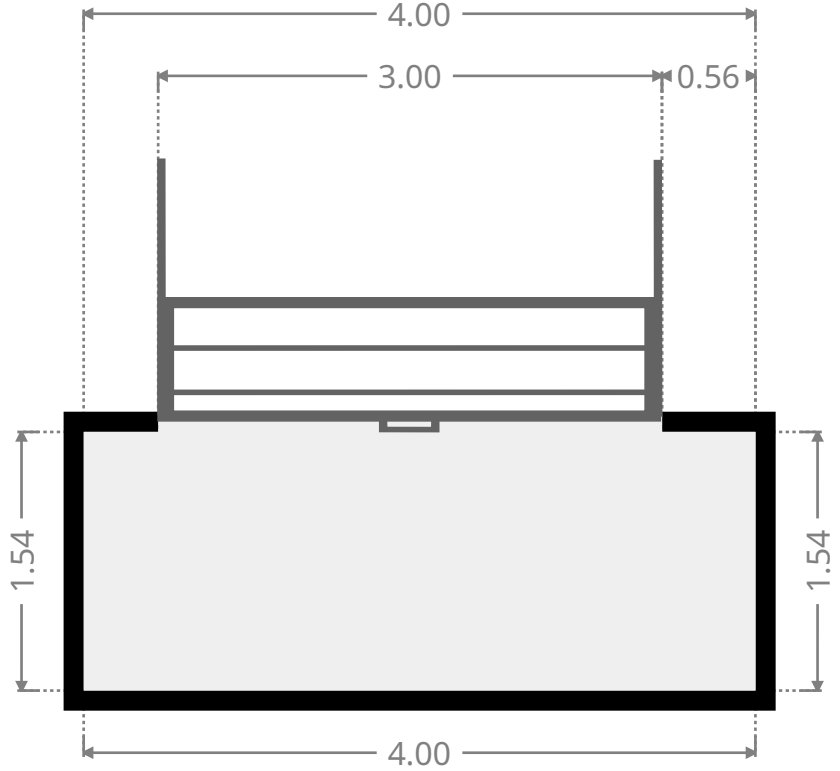
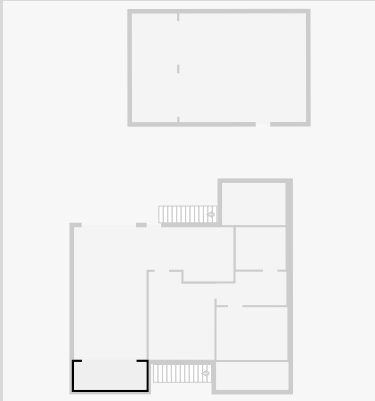

Other

Width: 1.54 m
 Length: 4.00 m
 Area: 6.16 m²
 Perimeter: 11.08 m

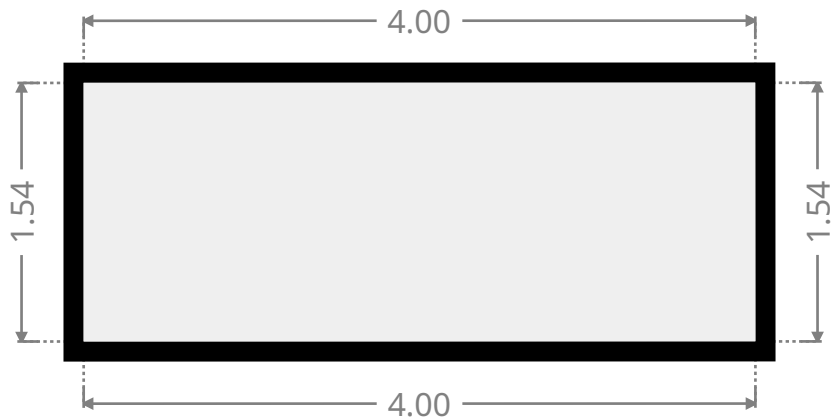

157 Hyde Street

1st Floor



THIS FLOORPLAN IS PROVIDED WITHOUT WARRANTY OF ANY KIND. SENSOPIA DISCLAIMS ANY WARRANTY INCLUDING, WITHOUT LIMITATION, SATISFACTORY QUALITY OR ACCURACY OF DIMENSIONS.

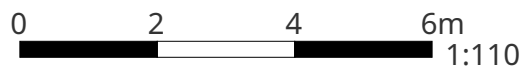

157 Hyde Street

Sunroom

Width: 1.56 m
 Length: 4.86 m
 Area: 7.58 m²
 Perimeter: 12.84 m

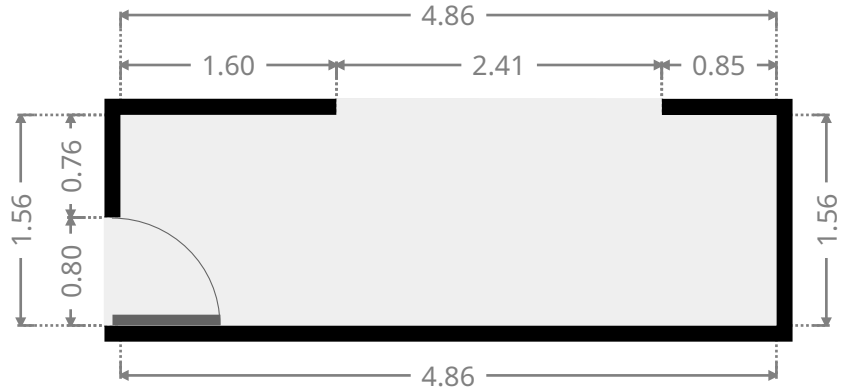
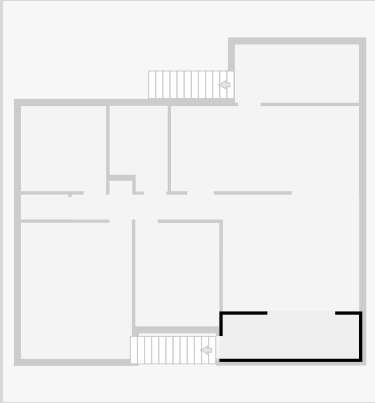

Living Room

Width: 4.17 m
 Length: 4.87 m
 Area: 20.31 m²
 Perimeter: 18.08 m

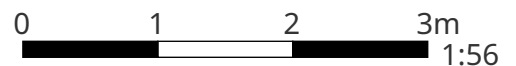
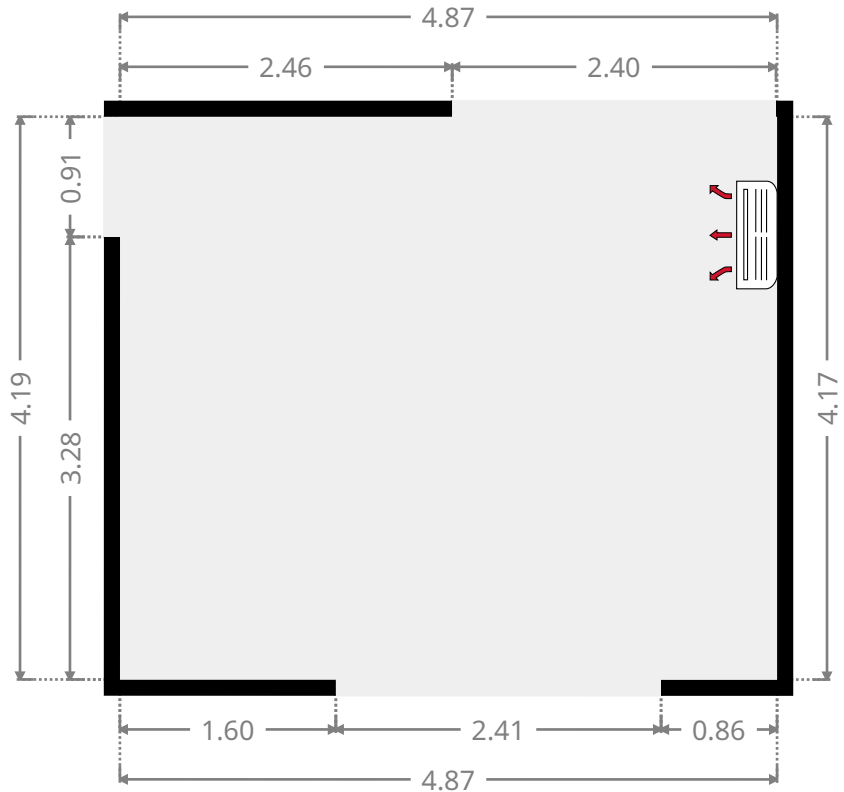
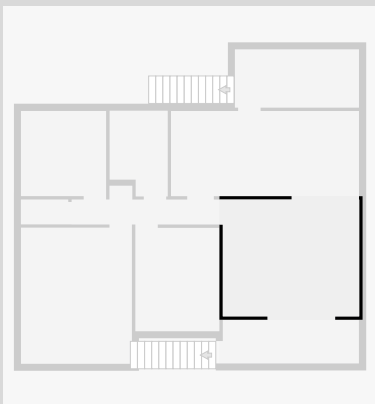

THIS FLOORPLAN IS PROVIDED WITHOUT WARRANTY OF ANY KIND. SENSOPIA DISCLAIMS ANY WARRANTY INCLUDING, WITHOUT LIMITATION, SATISFACTORY QUALITY OR ACCURACY OF DIMENSIONS.

157 Hyde Street

Kitchen

Width: 3.04 m
 Length: 6.71 m
 Area: 20.40 m²
 Perimeter: 19.50 m

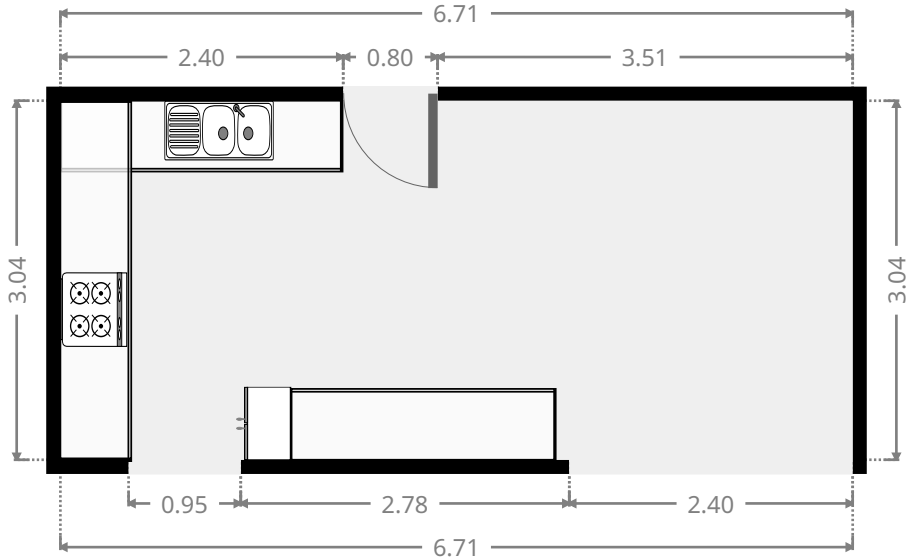
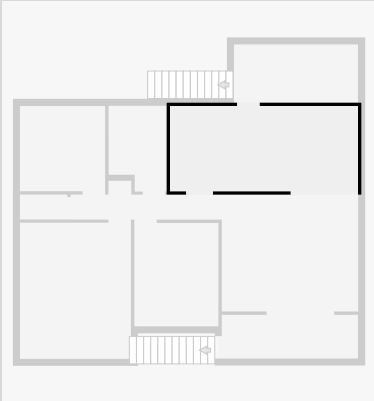

Hall

Width: 1.38 m
 Length: 5.28 m
 Area: 5.10 m²
 Perimeter: 13.33 m

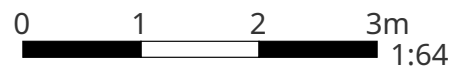
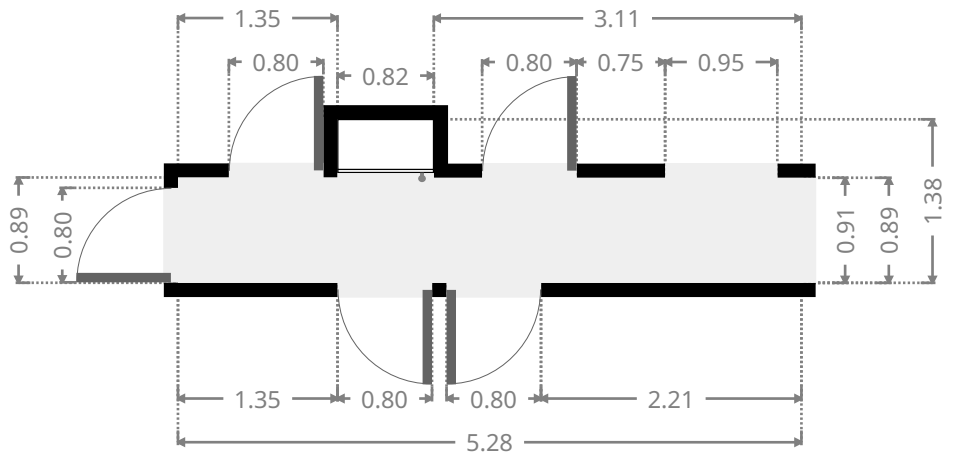
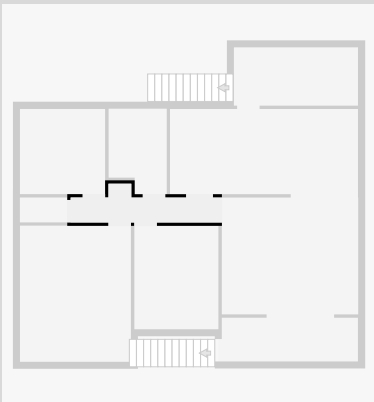

THIS FLOORPLAN IS PROVIDED WITHOUT WARRANTY OF ANY KIND. SENSOPIA DISCLAIMS ANY WARRANTY INCLUDING, WITHOUT LIMITATION, SATISFACTORY QUALITY OR ACCURACY OF DIMENSIONS.

157 Hyde Street

Bathroom

Width: 2.07 m
 Length: 3.06 m
 Area: 5.79 m²
 Perimeter: 10.27 m

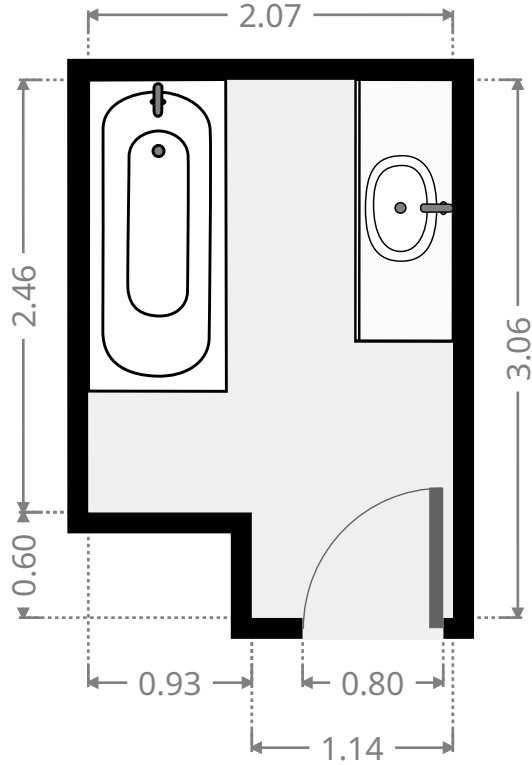
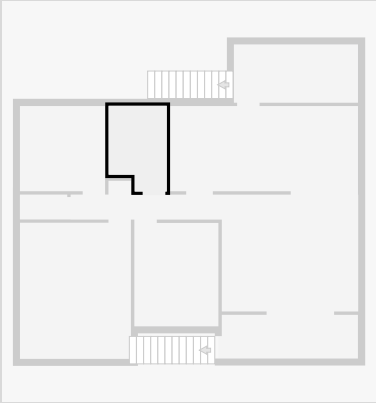

Bedroom

Width: 3.04 m
 Length: 3.04 m
 Area: 9.24 m²
 Perimeter: 12.16 m

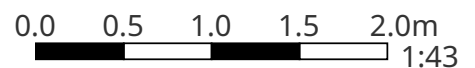
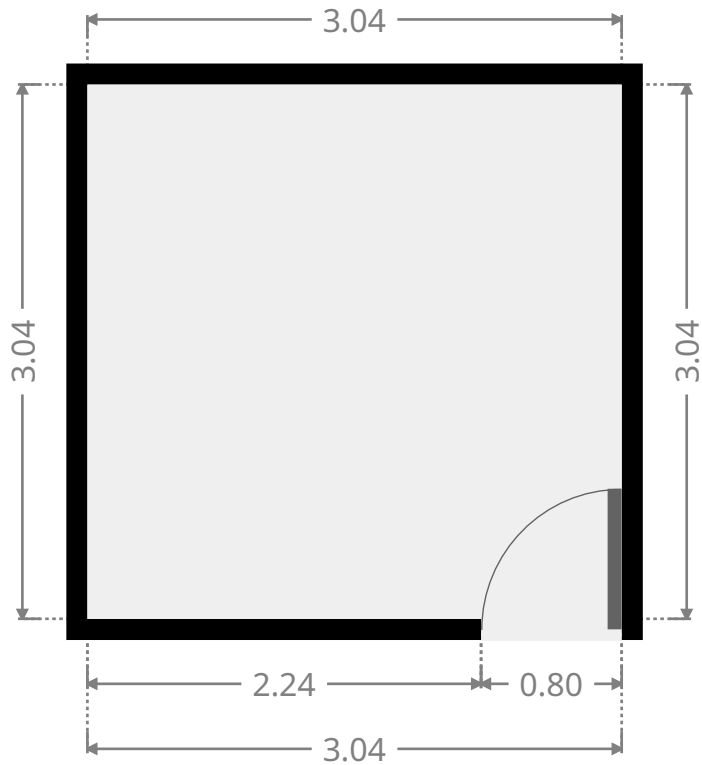
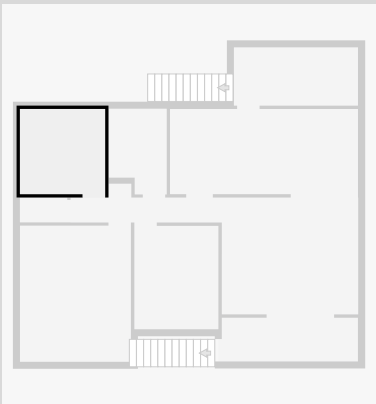

THIS FLOORPLAN IS PROVIDED WITHOUT WARRANTY OF ANY KIND. SENSOPIA DISCLAIMS ANY WARRANTY INCLUDING, WITHOUT LIMITATION, SATISFACTORY QUALITY OR ACCURACY OF DIMENSIONS.

157 Hyde Street

Toilet / Half Bath

Width: 0.89 m
Length: 1.69 m
Area: 1.50 m²
Perimeter: 5.16 m

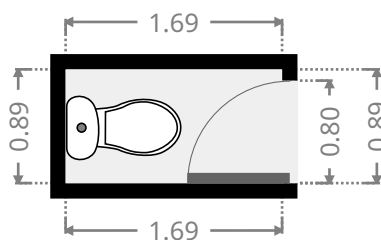
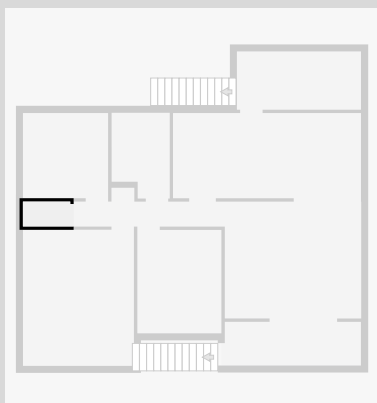

Master Bedroom

Width: 3.96 m
Length: 4.86 m
Area: 19.24 m²
Perimeter: 17.64 m

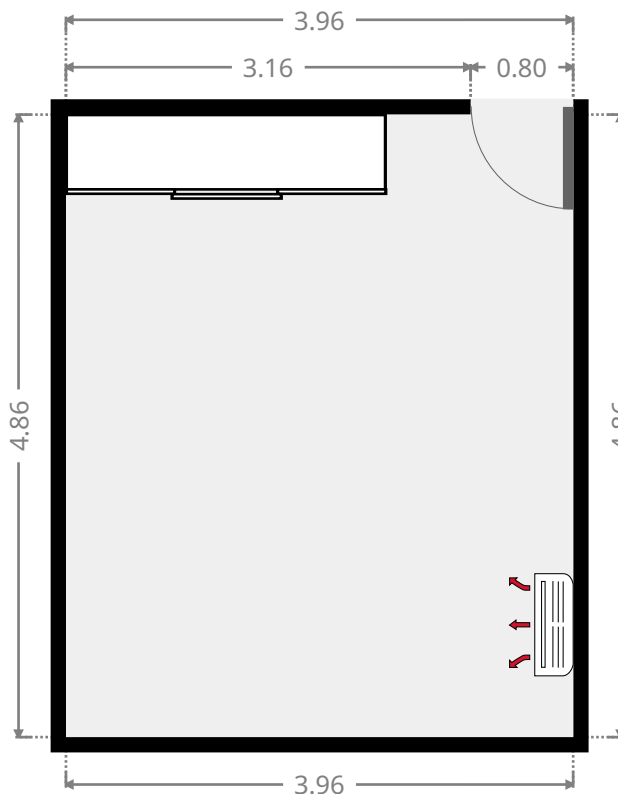
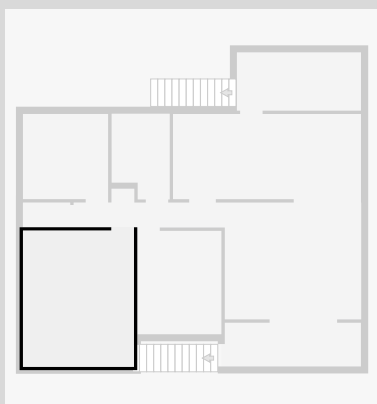

157 Hyde Street

Bedroom

Width: 3.00 m
 Length: 3.69 m
 Area: 11.07 m²
 Perimeter: 13.38 m

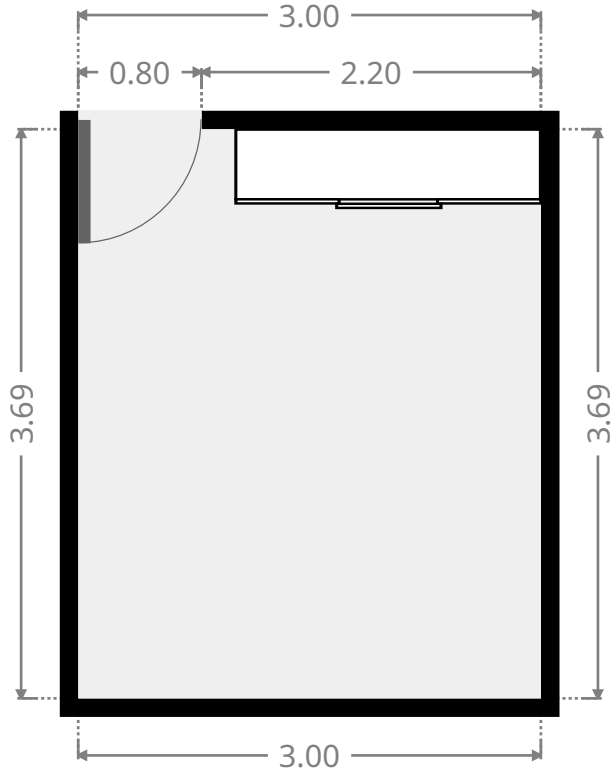
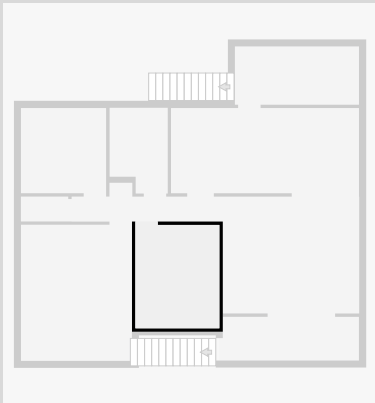

Deck

Width: 2.08 m
 Length: 4.43 m
 Area: 9.21 m²
 Perimeter: 13.02 m

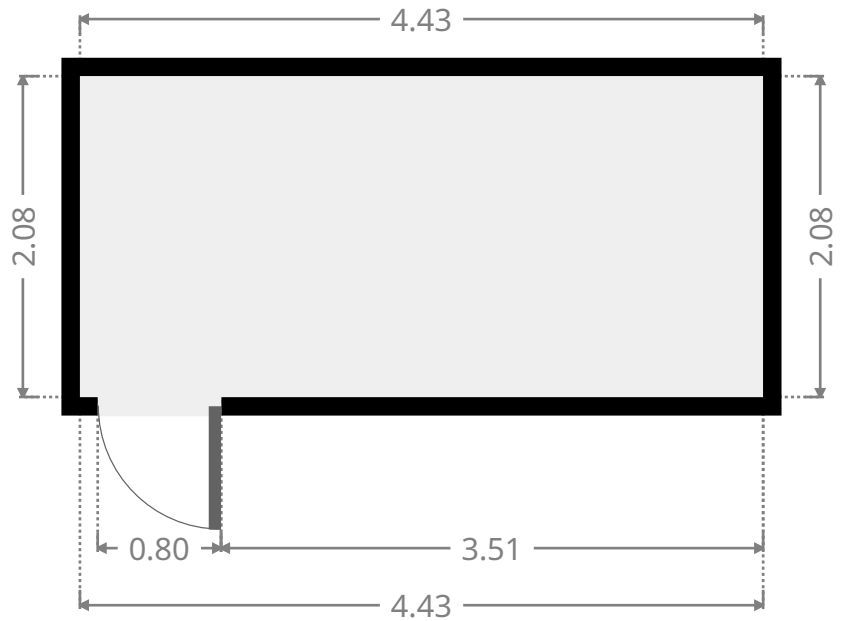
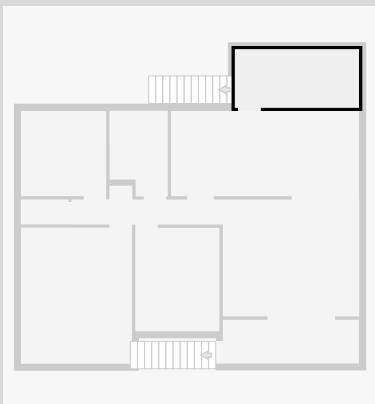

THIS FLOORPLAN IS PROVIDED WITHOUT WARRANTY OF ANY KIND. SENSOPIA DISCLAIMS ANY WARRANTY INCLUDING, WITHOUT LIMITATION, SATISFACTORY QUALITY OR ACCURACY OF DIMENSIONS.

