

152 Agnes Street

Created on
2021-06-29

Floors
2

▼ Ground Floor

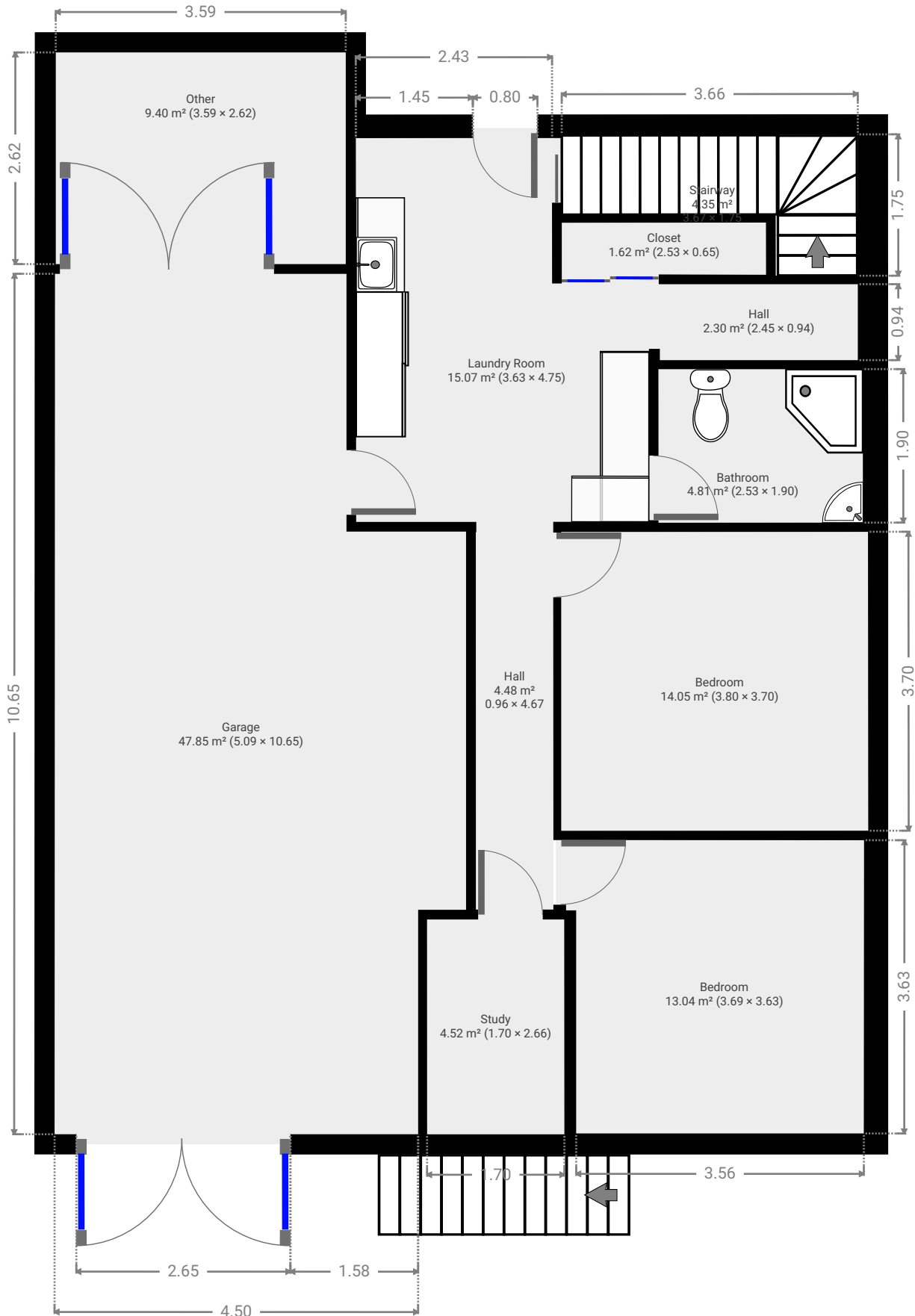

▼ **Study**
Ground Floor

WIDTH: 1.70 m • LENGTH: 2.66 m
AREA: 4.52 m² • PERIMETER: 8.72 m

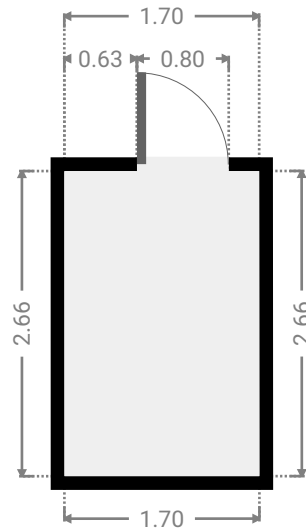
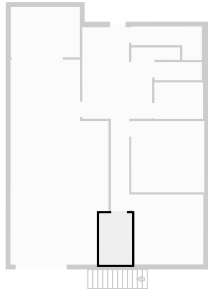

▼ **Hall**
Ground Floor

WIDTH: 0.96 m • LENGTH: 4.67 m
AREA: 4.48 m² • PERIMETER: 11.26 m

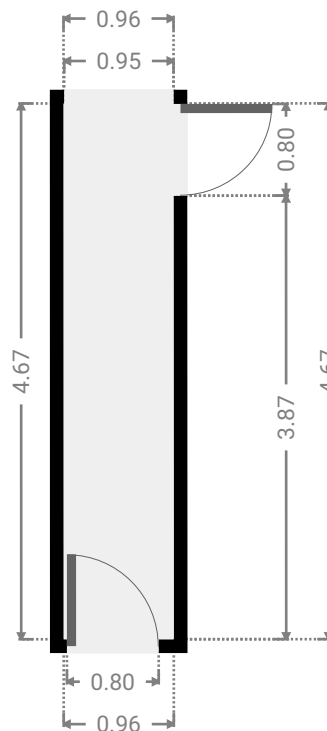
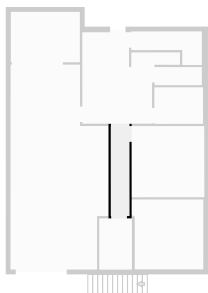

▼ **Bedroom**
Ground Floor

WIDTH: 3.69 m • LENGTH: 3.63 m
AREA: 13.04 m² • PERIMETER: 14.63 m

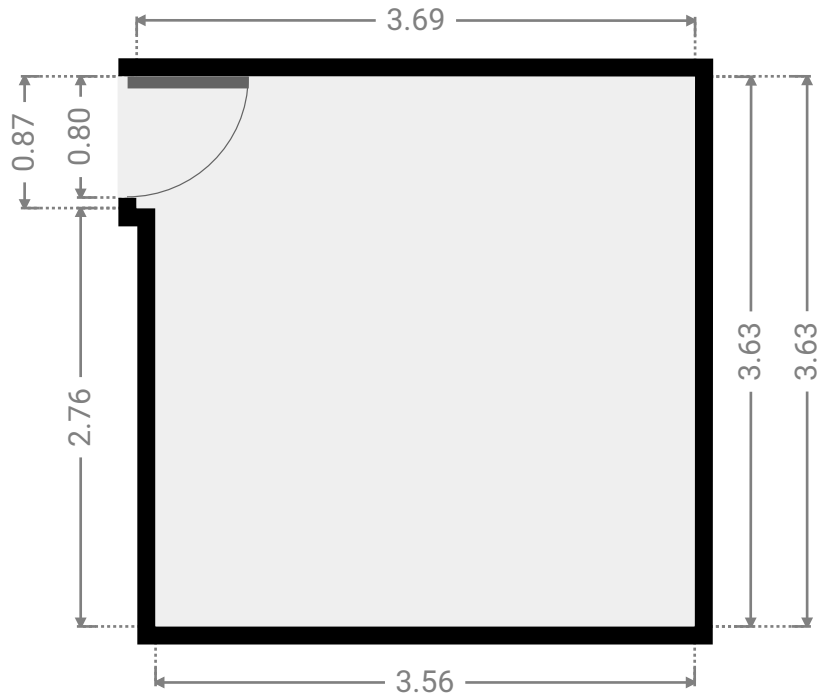
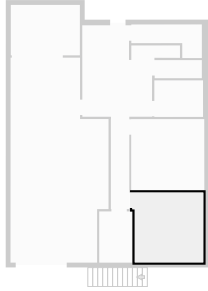

▼ **Bedroom**
Ground Floor

WIDTH: 3.80 m • LENGTH: 3.70 m
AREA: 14.05 m² • PERIMETER: 15.00 m

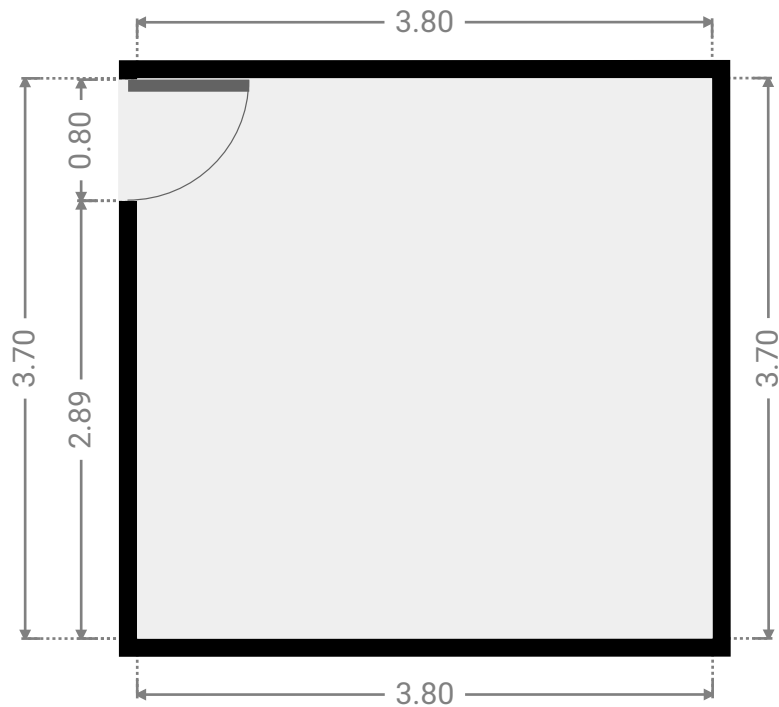
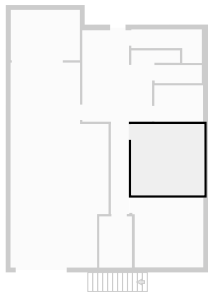

▼ Laundry Room
Ground Floor

WIDTH: 3.63 m • LENGTH: 4.75 m
AREA: 15.07 m² • PERIMETER: 16.75 m

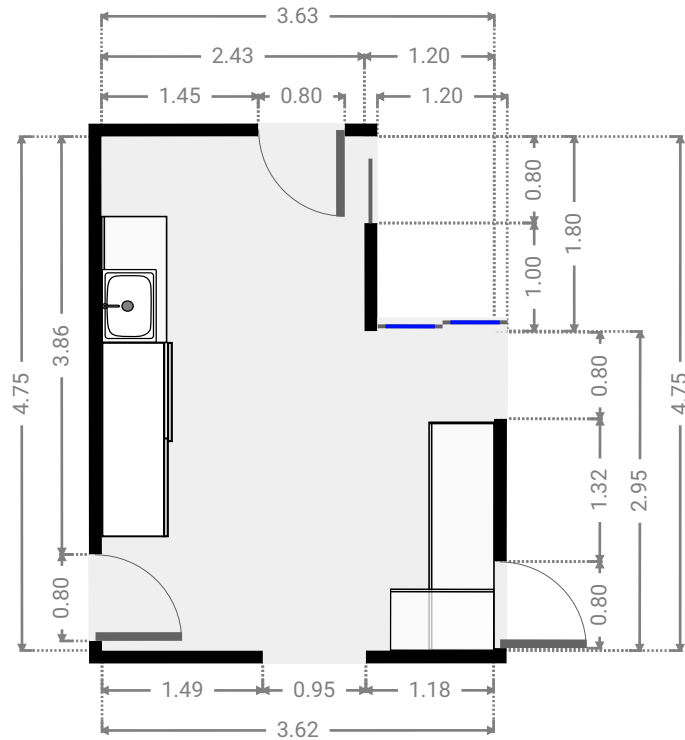
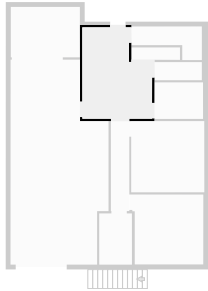

▼ Bathroom
Ground Floor

WIDTH: 2.53 m • LENGTH: 1.90 m
AREA: 4.81 m² • PERIMETER: 8.86 m

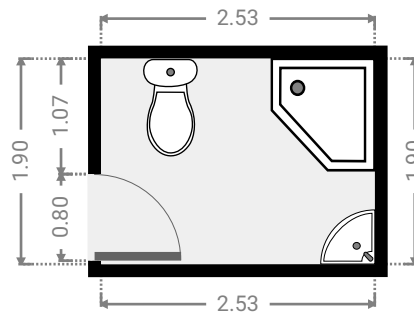
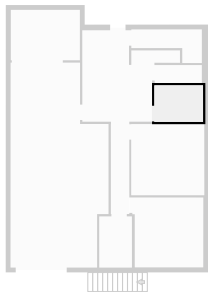

▼ **Hall**
Ground Floor

WIDTH: 2.45 m • LENGTH: 0.94 m
AREA: 2.30 m² • PERIMETER: 6.78 m

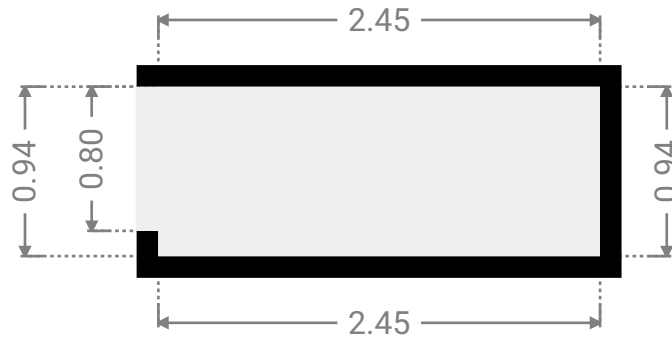
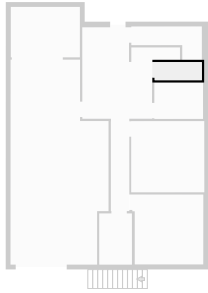

▼ **Stairway**
Ground Floor

WIDTH: 3.67 m • LENGTH: 1.75 m
AREA: 4.35 m² • PERIMETER: 10.83 m

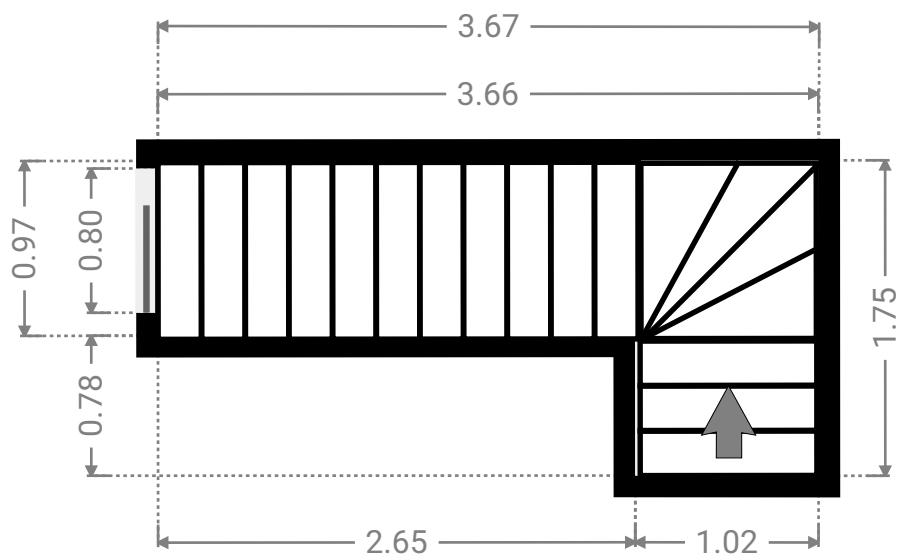
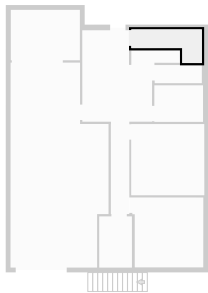

▼ **Closet**
Ground Floor

WIDTH: 2.53 m • LENGTH: 0.65 m
AREA: 1.62 m² • PERIMETER: 6.34 m

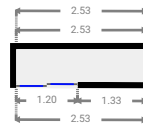
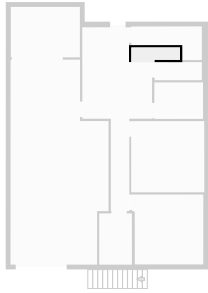

▼ **Garage**
Ground Floor

WIDTH: 5.09 m • LENGTH: 10.65 m
AREA: 47.85 m² • PERIMETER: 31.48 m

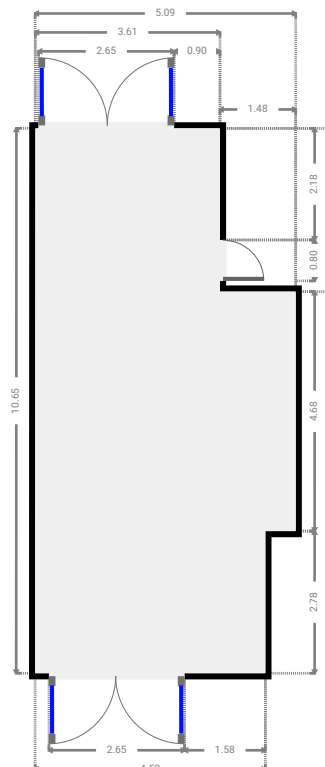
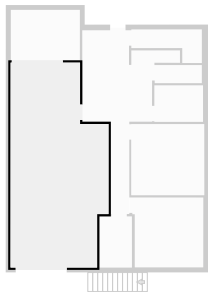

▼ Other
Ground Floor

WIDTH: 3.59 m • LENGTH: 2.62 m
AREA: 9.40 m² • PERIMETER: 12.42 m

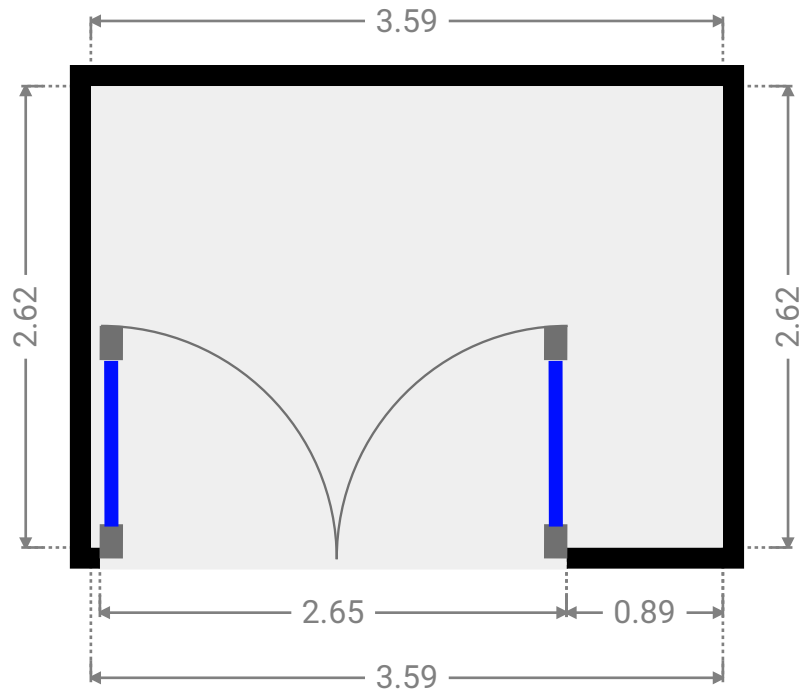
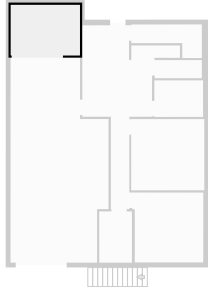

▼ 1st Floor

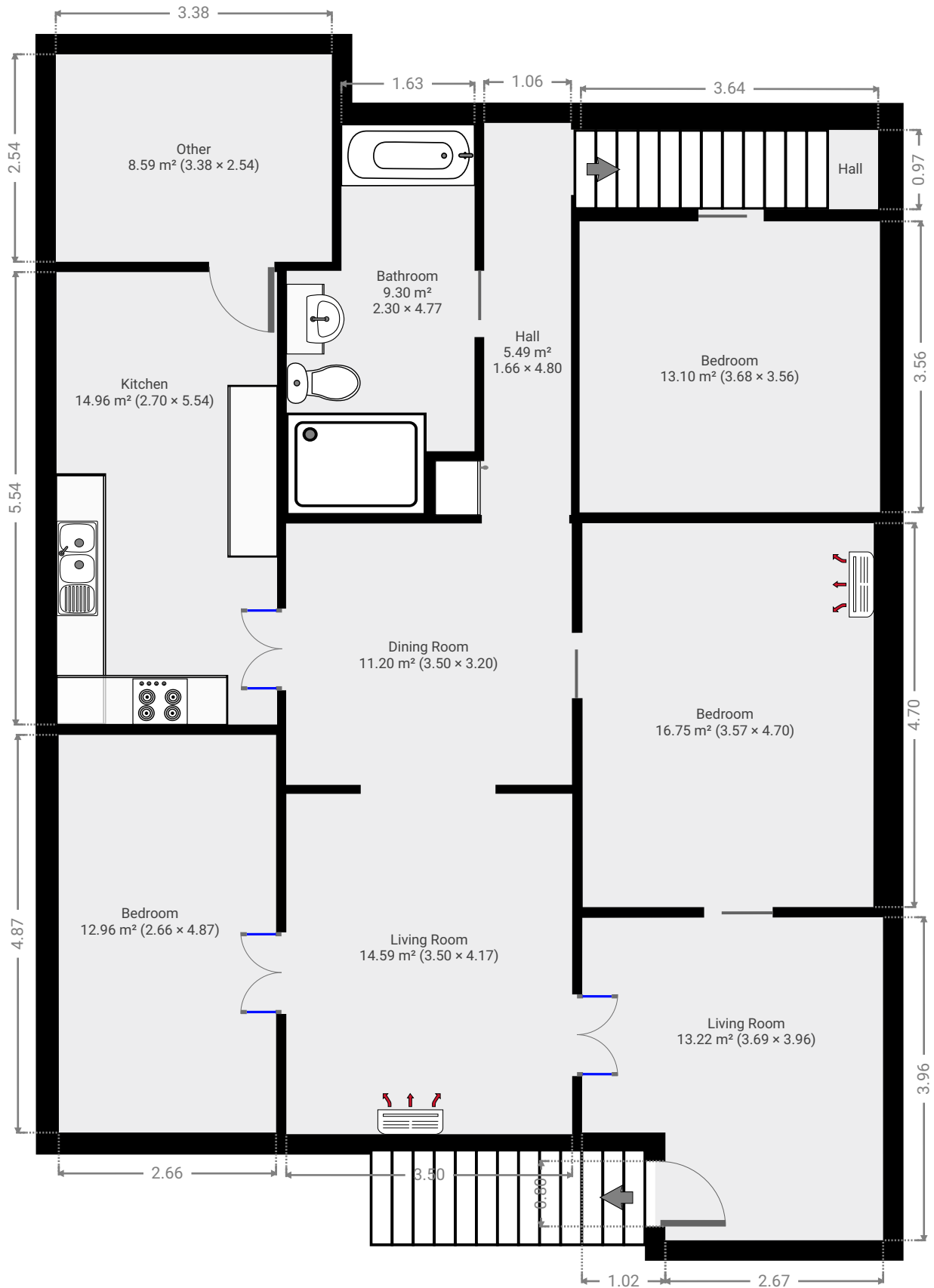

▼ Living Room
1st Floor

WIDTH: 3.69 m • LENGTH: 3.96 m
AREA: 13.22 m² • PERIMETER: 15.28 m

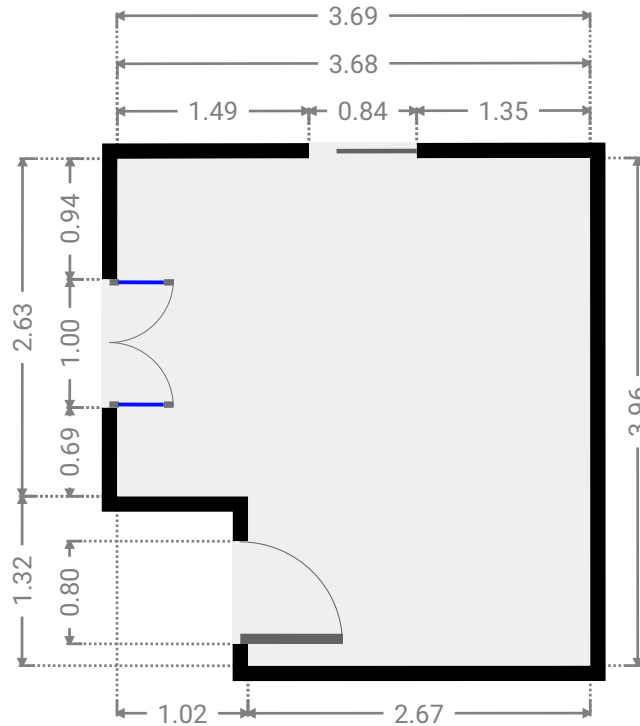
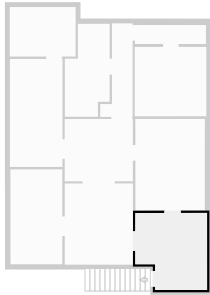

▼ Living Room
1st Floor

WIDTH: 3.50 m • LENGTH: 4.17 m
AREA: 14.59 m² • PERIMETER: 15.34 m

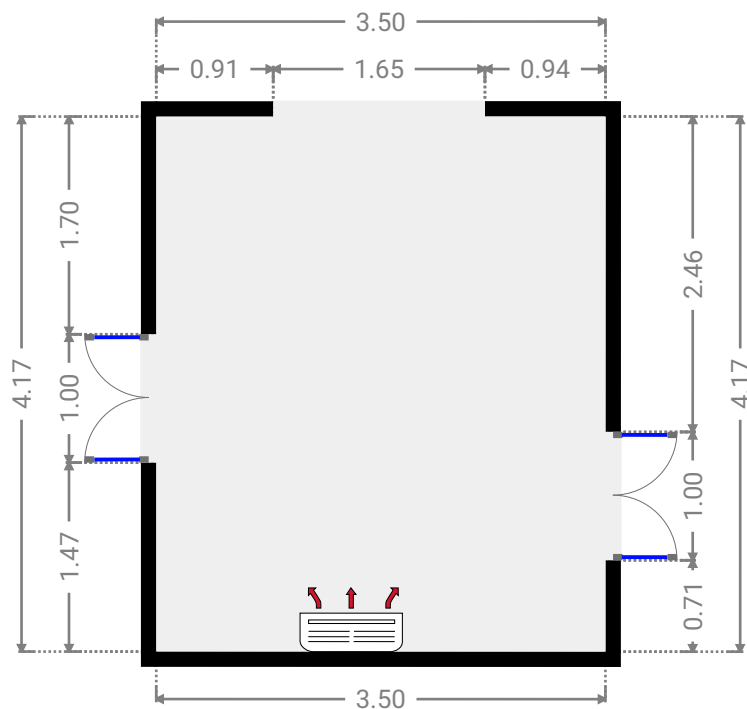
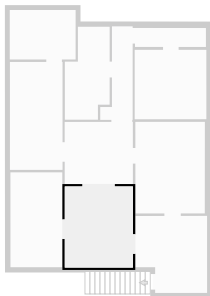

▼ Dining Room
1st Floor

WIDTH: 3.50 m • LENGTH: 3.20 m
AREA: 11.20 m² • PERIMETER: 13.40 m

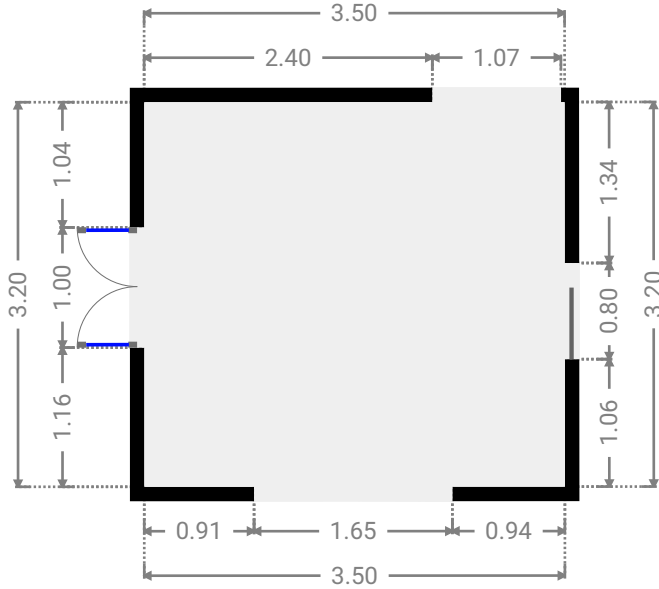
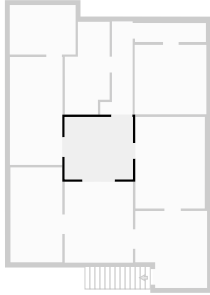

▼ Bedroom
1st Floor

WIDTH: 3.56 m • LENGTH: 4.70 m
AREA: 16.75 m² • PERIMETER: 16.53 m

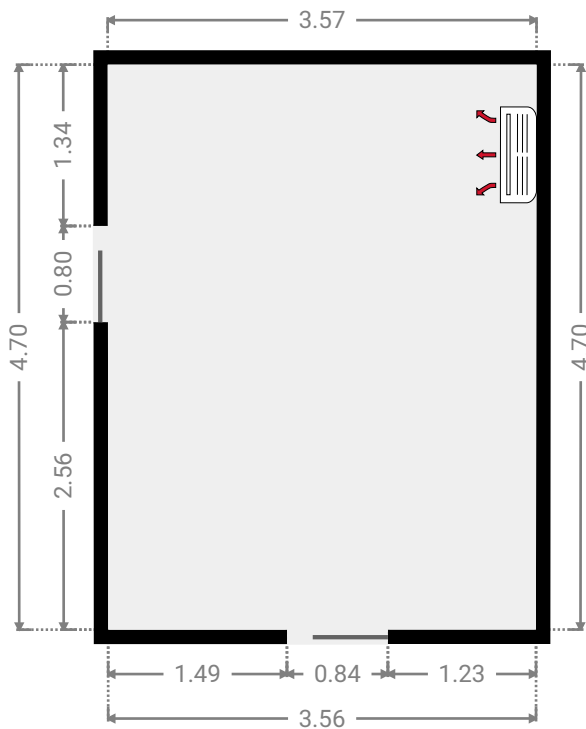
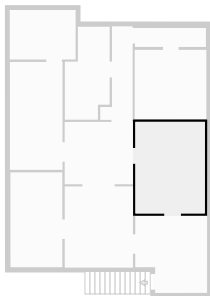

▼ **Bedroom**
1st Floor

WIDTH: 2.66 m • LENGTH: 4.87 m
AREA: 12.96 m² • PERIMETER: 15.06 m

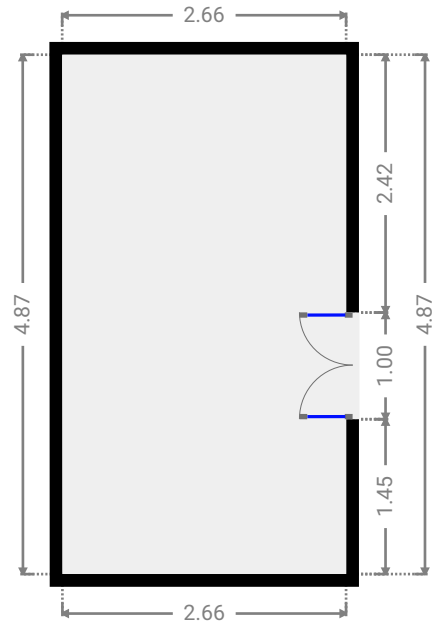
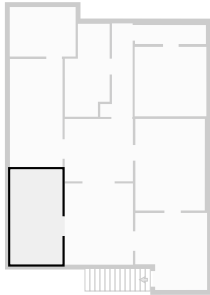

▼ **Kitchen**
1st Floor

WIDTH: 2.70 m • LENGTH: 5.54 m
AREA: 14.96 m² • PERIMETER: 16.48 m

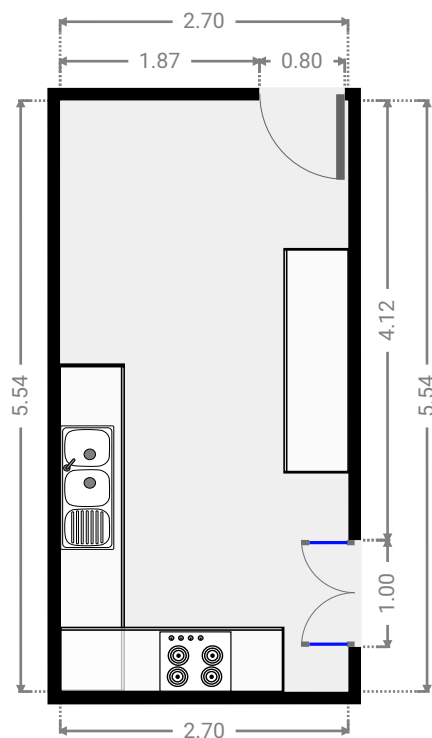
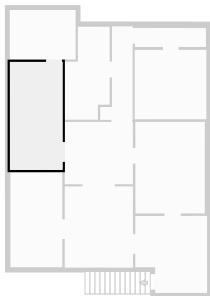

▼ **Hall**
1st Floor

WIDTH: 1.70 m • LENGTH: 4.80 m
AREA: 5.49 m² • PERIMETER: 12.92 m

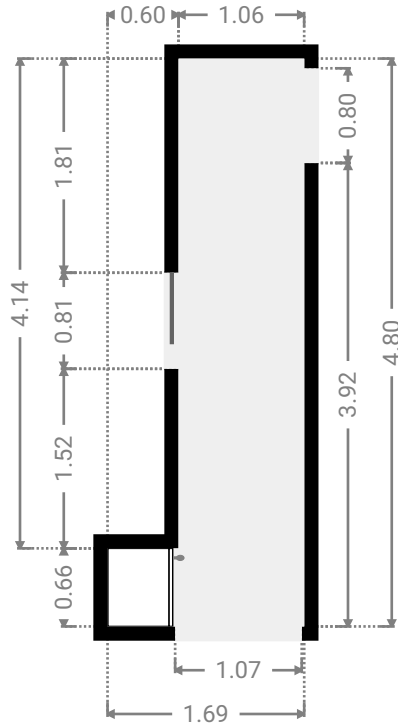
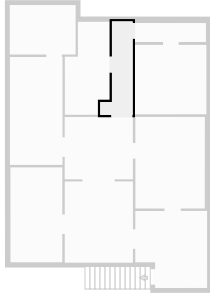

▼ **Bathroom**
1st Floor

WIDTH: 2.30 m • LENGTH: 4.77 m
AREA: 9.30 m² • PERIMETER: 14.14 m

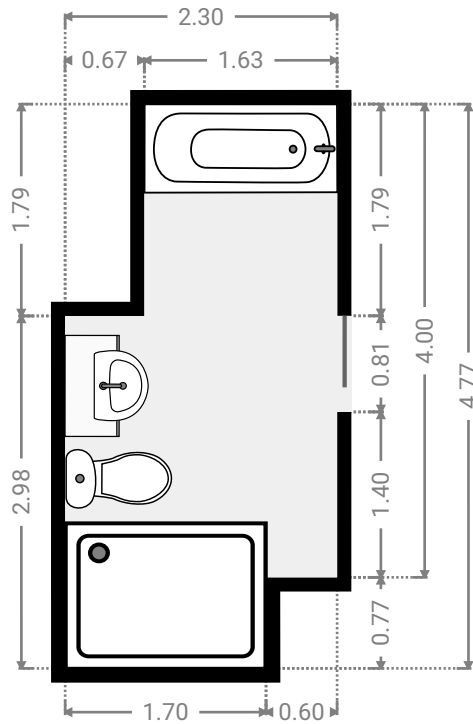
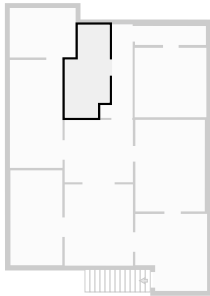

▼ **Hall**
1st Floor

WIDTH: 3.64 m • LENGTH: 0.97 m
AREA: 3.54 m² • PERIMETER: 9.22 m

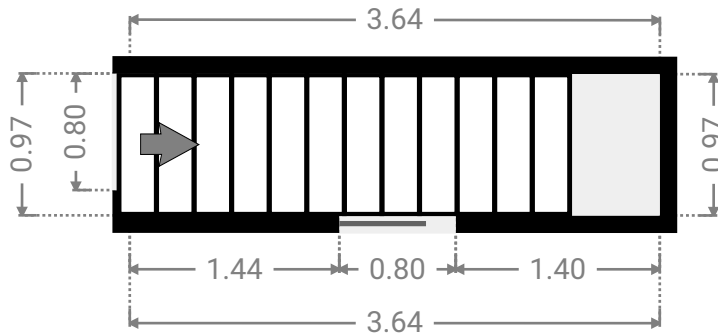
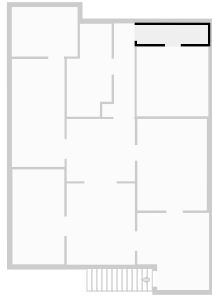

▼ **Bedroom**
1st Floor

WIDTH: 3.68 m • LENGTH: 3.56 m
AREA: 13.10 m² • PERIMETER: 14.48 m

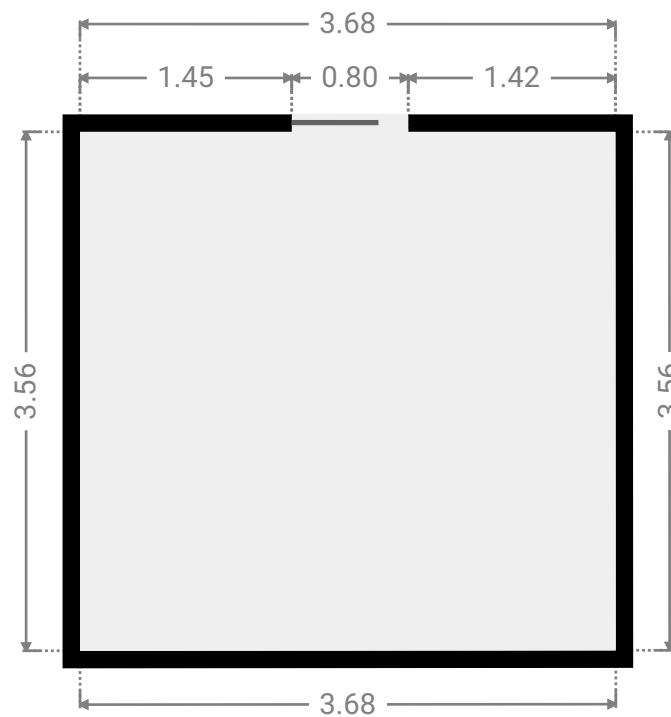
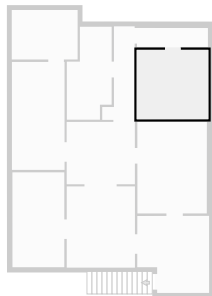

▼ Other
1st Floor

WIDTH: 3.38 m • LENGTH: 2.54 m
AREA: 8.59 m² • PERIMETER: 11.84 m

