

51 Earl Street

Ground Floor

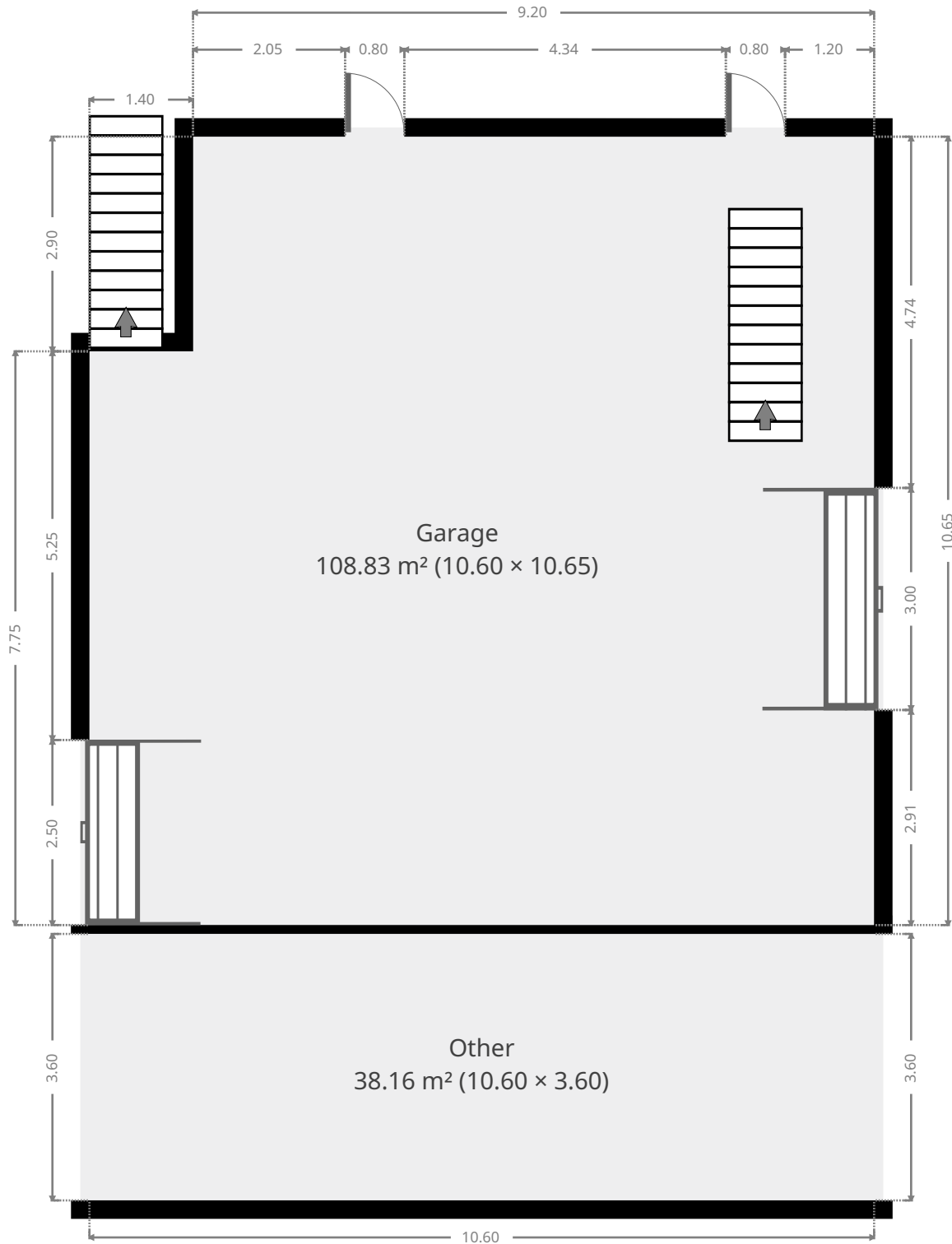

THIS FLOORPLAN IS PROVIDED WITHOUT WARRANTY OF ANY KIND. SENSOPIA DISCLAIMS ANY WARRANTY INCLUDING, WITHOUT LIMITATION, SATISFACTORY QUALITY OR ACCURACY OF DIMENSIONS.



51 Earl Street

Garage

Width: 10.60 m
Length: 10.65 m
Area: 108.83 m²
Perimeter: 42.50 m

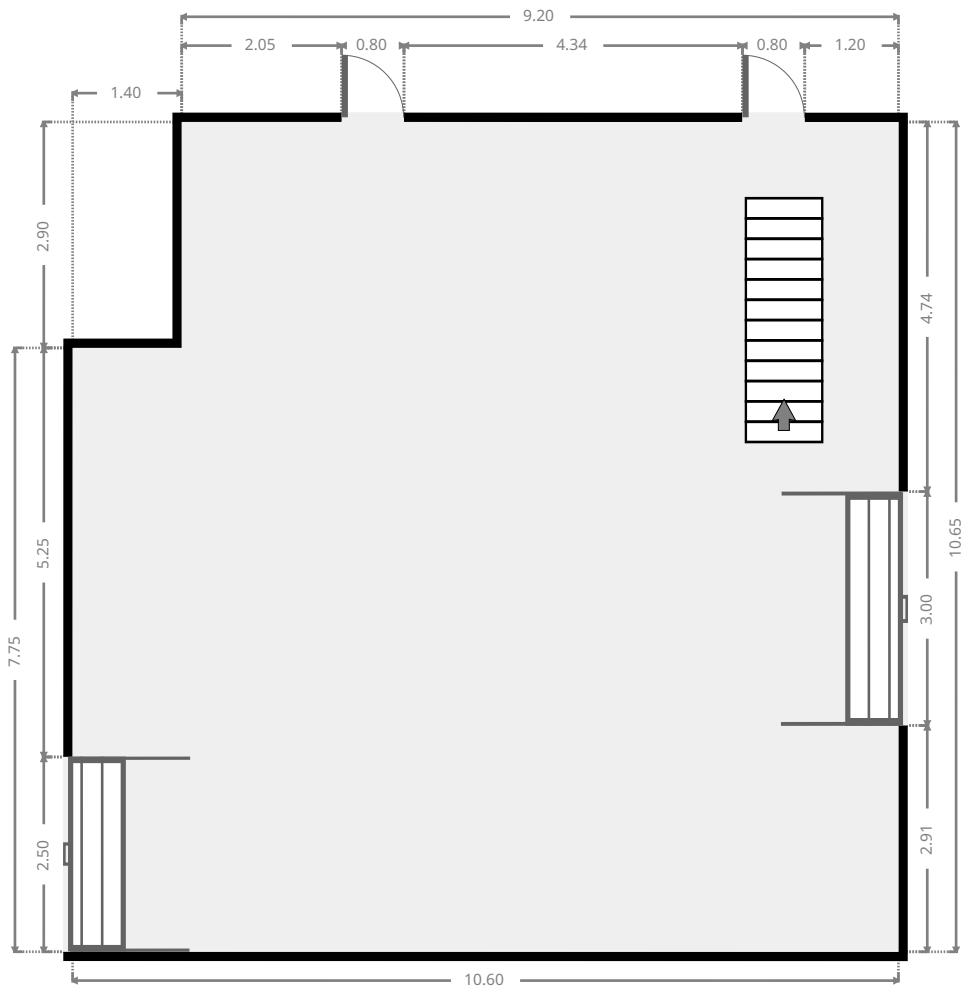
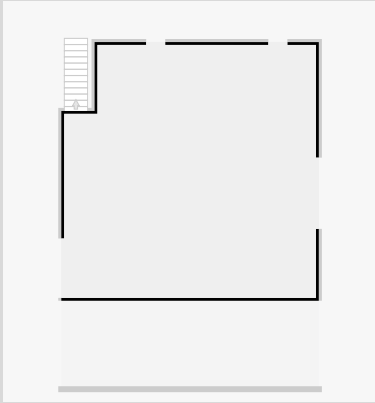

THIS FLOORPLAN IS PROVIDED WITHOUT WARRANTY OF ANY KIND. SENSOPIA DISCLAIMS ANY WARRANTY INCLUDING, WITHOUT LIMITATION, SATISFACTORY QUALITY OR ACCURACY OF DIMENSIONS.



51 Earl Street

Other

Width:	3.60 m
Length:	10.60 m
Area	38.16 m ²
Perimeter	28.40 m

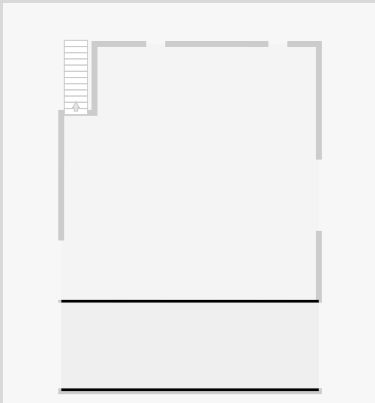

THIS FLOORPLAN IS PROVIDED WITHOUT WARRANTY OF ANY KIND. SENSOPIA DISCLAIMS ANY WARRANTY INCLUDING, WITHOUT LIMITATION, SATISFACTORY QUALITY OR ACCURACY OF DIMENSIONS.

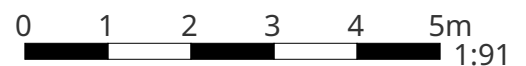

51 Earl Street

1st Floor

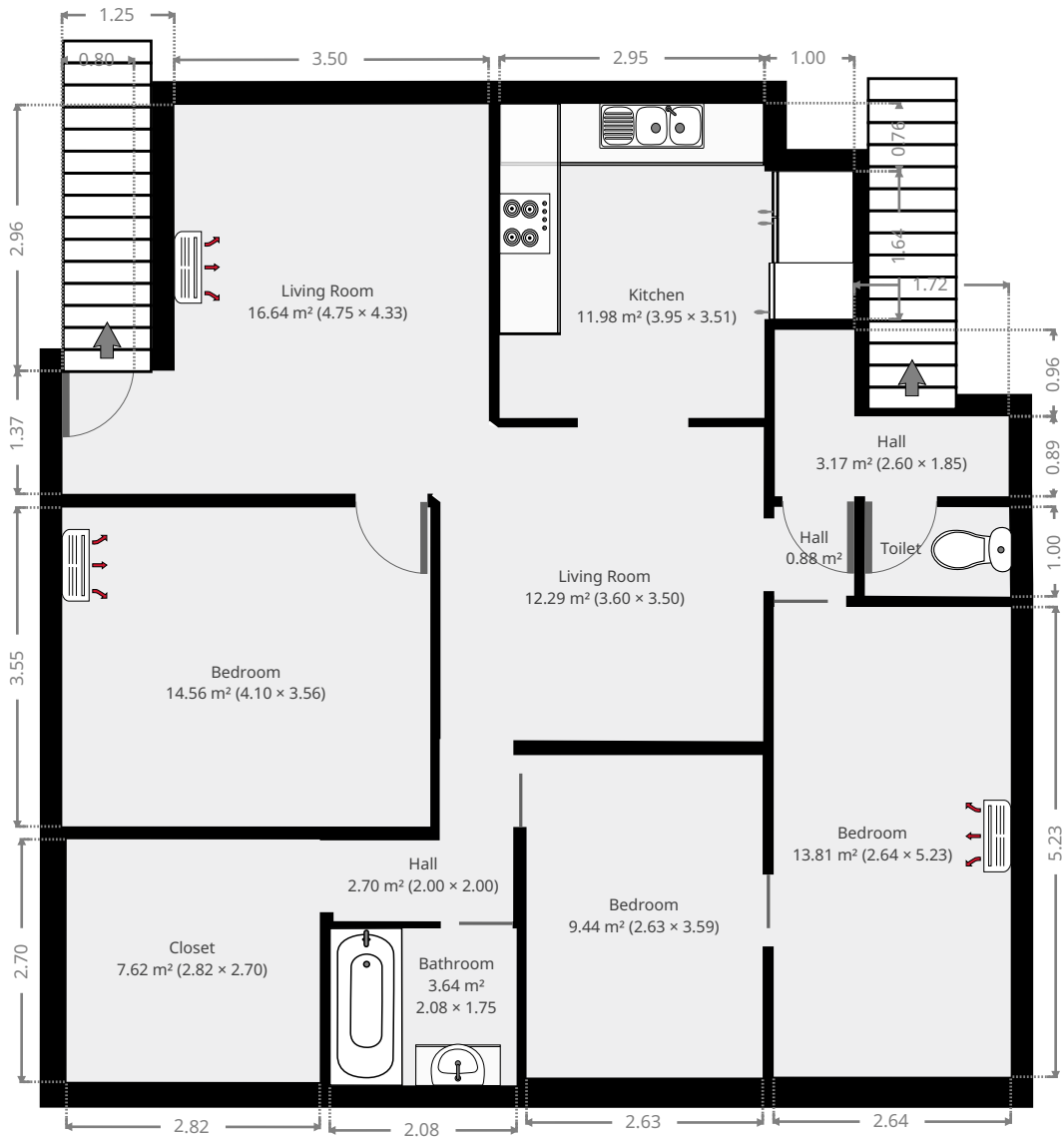

THIS FLOORPLAN IS PROVIDED WITHOUT WARRANTY OF ANY KIND. SENSOPIA DISCLAIMS ANY WARRANTY INCLUDING, WITHOUT LIMITATION, SATISFACTORY QUALITY OR ACCURACY OF DIMENSIONS.



51 Earl Street

Living Room

Width: 4.33 m
Length: 4.75 m
Area: 16.64 m²
Perimeter: 17.76 m

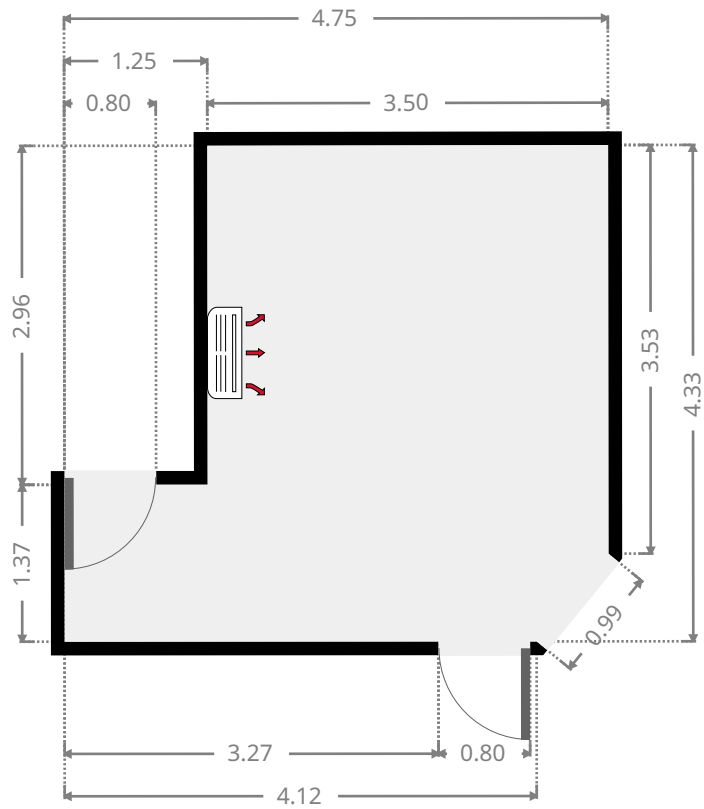
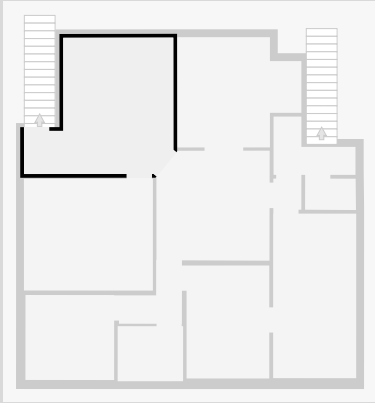

Bedroom

Width: 3.56 m
Length: 4.10 m
Area: 14.56 m²
Perimeter: 15.30 m

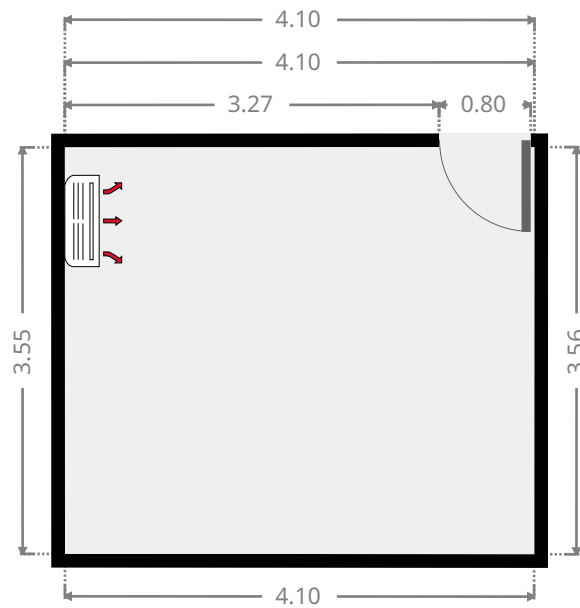
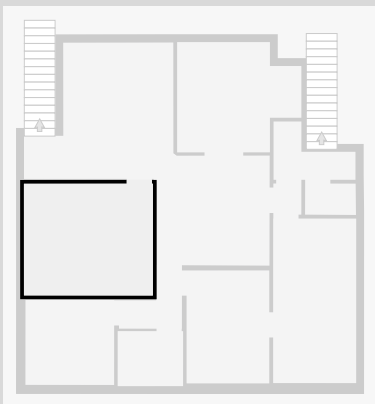

THIS FLOORPLAN IS PROVIDED WITHOUT WARRANTY OF ANY KIND. SENSOPIA DISCLAIMS ANY WARRANTY INCLUDING, WITHOUT LIMITATION, SATISFACTORY QUALITY OR ACCURACY OF DIMENSIONS.

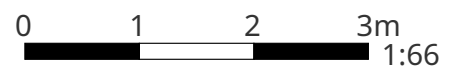

51 Earl Street

Closet

Width: 2.70 m
 Length: 2.82 m
 Area: 7.62 m²
 Perimeter: 11.04 m

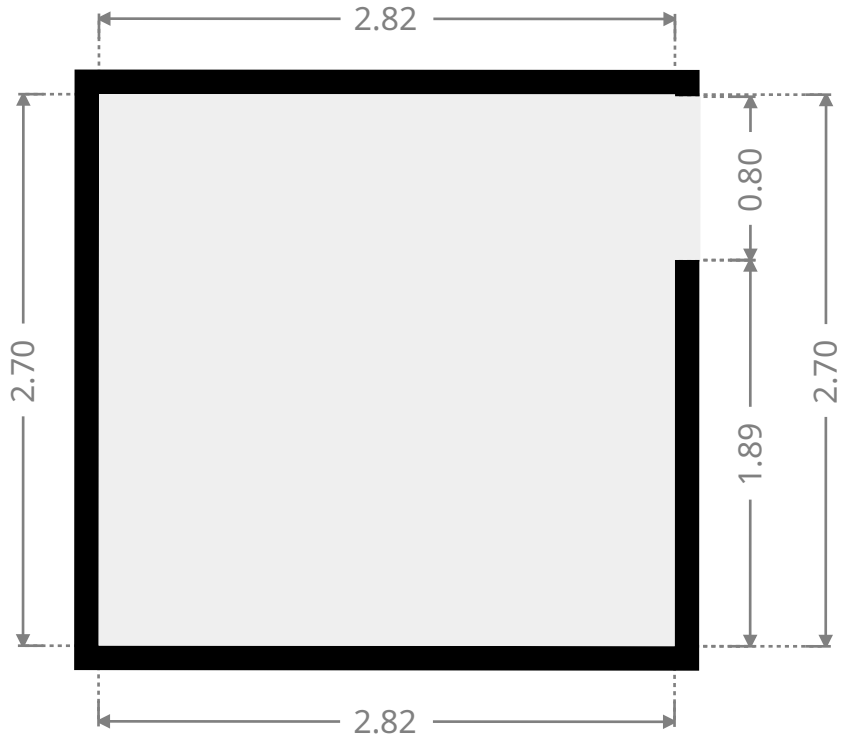
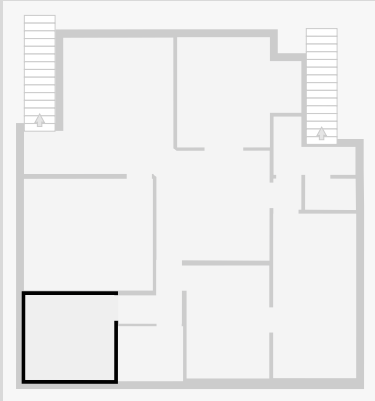

Hall

Width: 2.00 m
 Length: 2.00 m
 Area: 2.70 m²
 Perimeter: 8.00 m

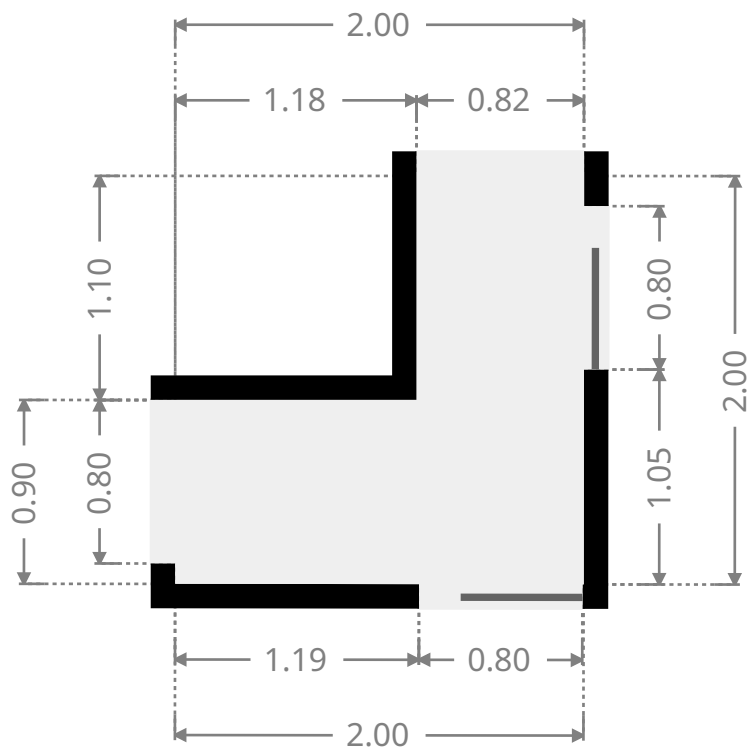
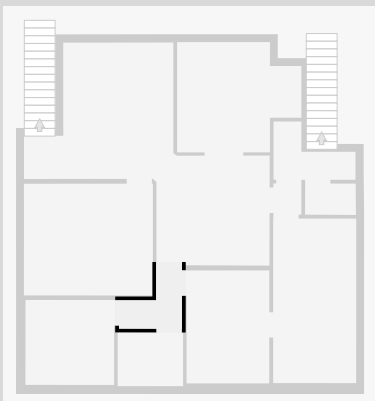

THIS FLOORPLAN IS PROVIDED WITHOUT WARRANTY OF ANY KIND. SENSOPIA DISCLAIMS ANY WARRANTY INCLUDING, WITHOUT LIMITATION, SATISFACTORY QUALITY OR ACCURACY OF DIMENSIONS.

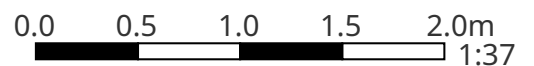

51 Earl Street

Bathroom

Width: 1.75 m
Length: 2.08 m
Area: 3.64 m²
Perimeter: 7.66 m

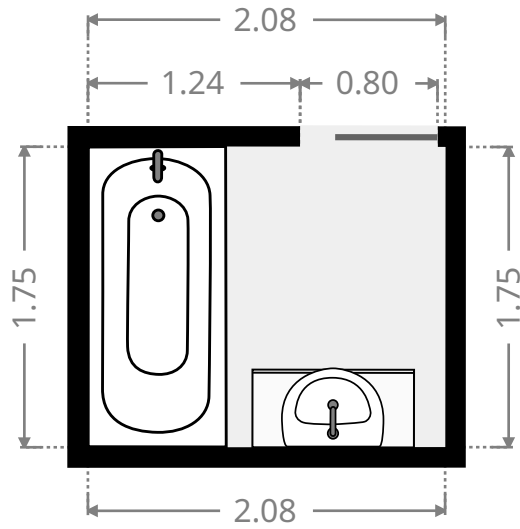
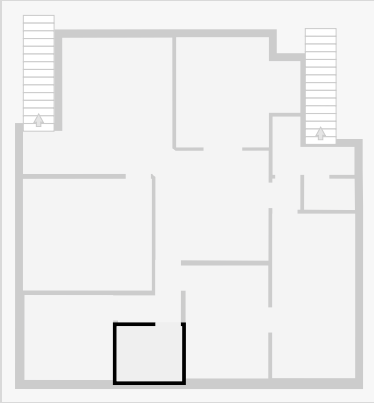

Bedroom

Width: 2.63 m
Length: 3.59 m
Area: 9.44 m²
Perimeter: 12.44 m

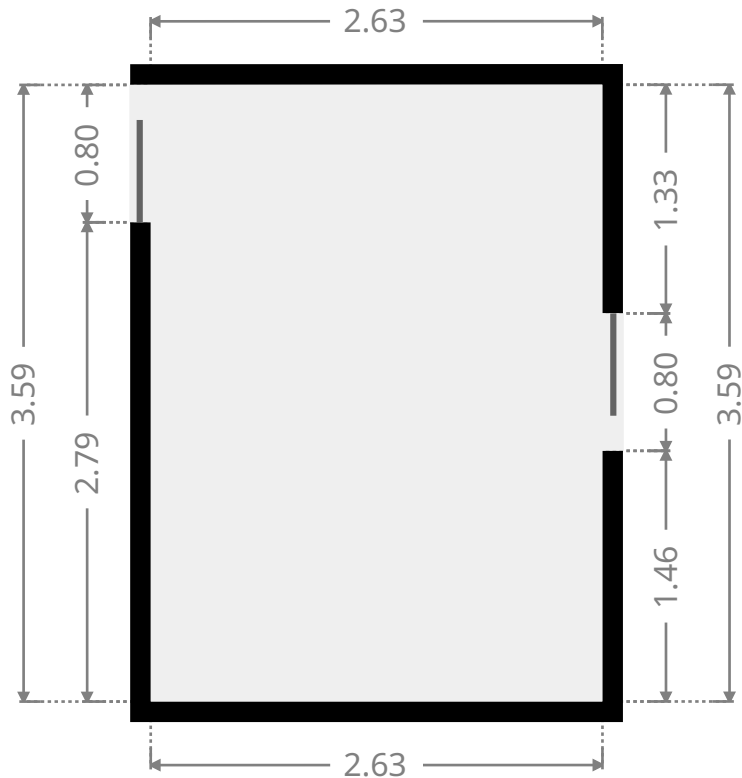
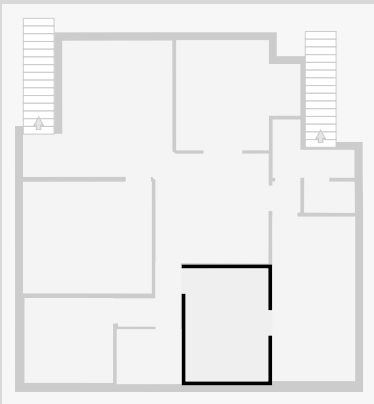

THIS FLOORPLAN IS PROVIDED WITHOUT WARRANTY OF ANY KIND. SENSOPIA DISCLAIMS ANY WARRANTY INCLUDING, WITHOUT LIMITATION, SATISFACTORY QUALITY OR ACCURACY OF DIMENSIONS.

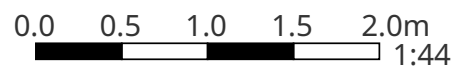

51 Earl Street

Living Room

Width: 3.50 m
 Length: 3.60 m
 Area: 12.29 m²
 Perimeter: 13.75 m

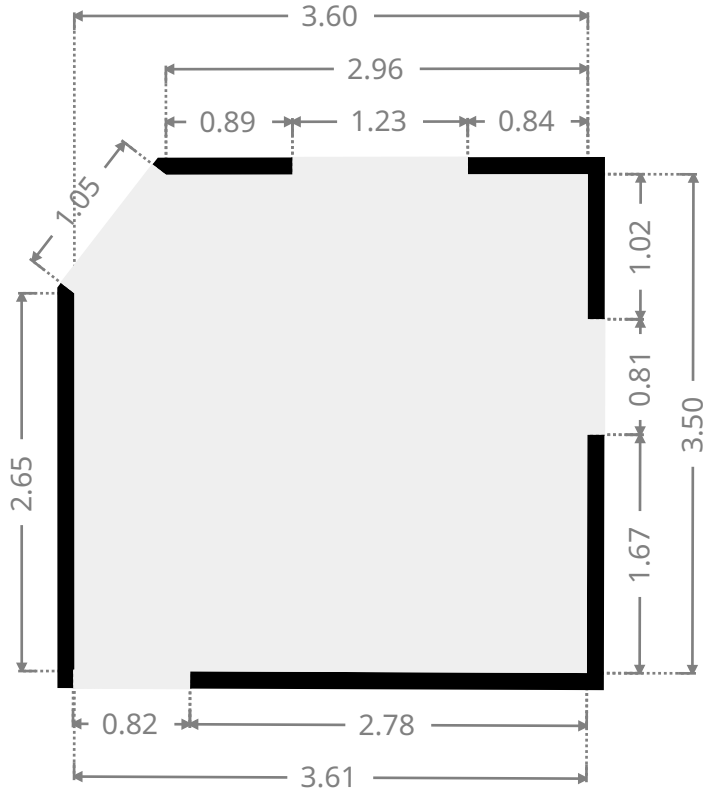
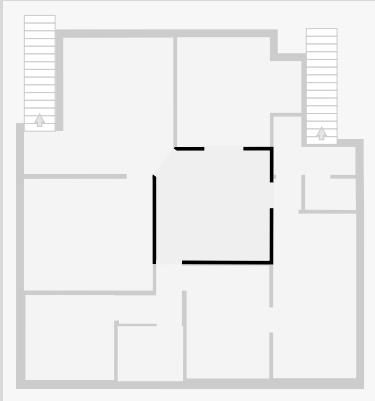

Kitchen

Width: 3.51 m
 Length: 3.95 m
 Area: 11.98 m²
 Perimeter: 14.91 m

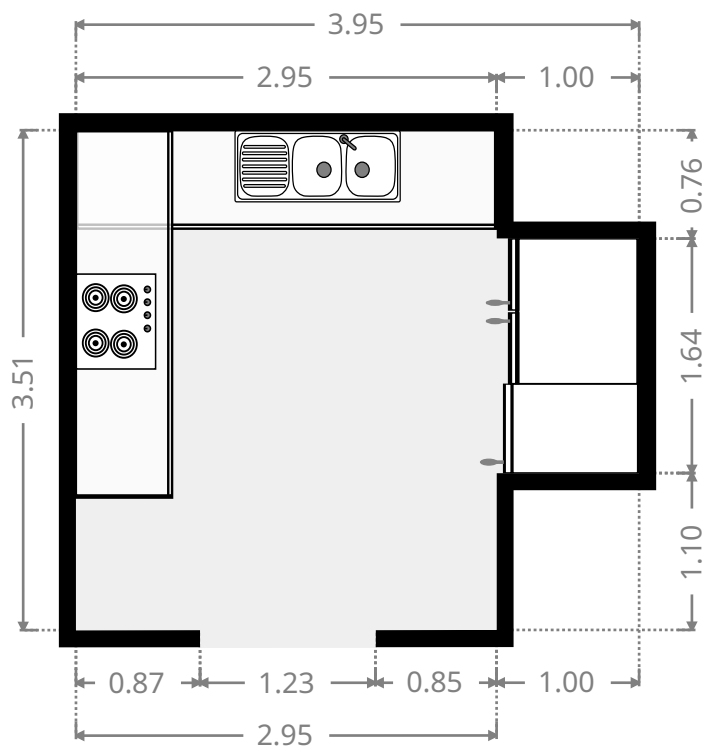
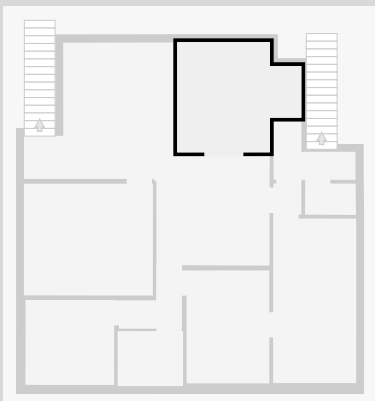

THIS FLOORPLAN IS PROVIDED WITHOUT WARRANTY OF ANY KIND. SENSOPIA DISCLAIMS ANY WARRANTY INCLUDING, WITHOUT LIMITATION, SATISFACTORY QUALITY OR ACCURACY OF DIMENSIONS.

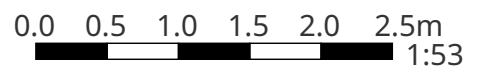

51 Earl Street

Hall

Width: 0.89 m
Length: 0.99 m
Area: 0.88 m²
Perimeter: 3.76 m

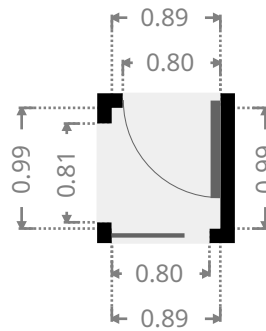
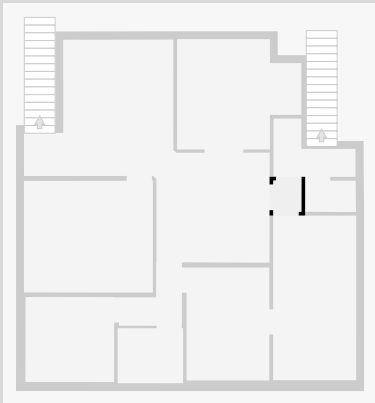

Bedroom

Width: 2.64 m
Length: 5.23 m
Area: 13.81 m²
Perimeter: 15.74 m

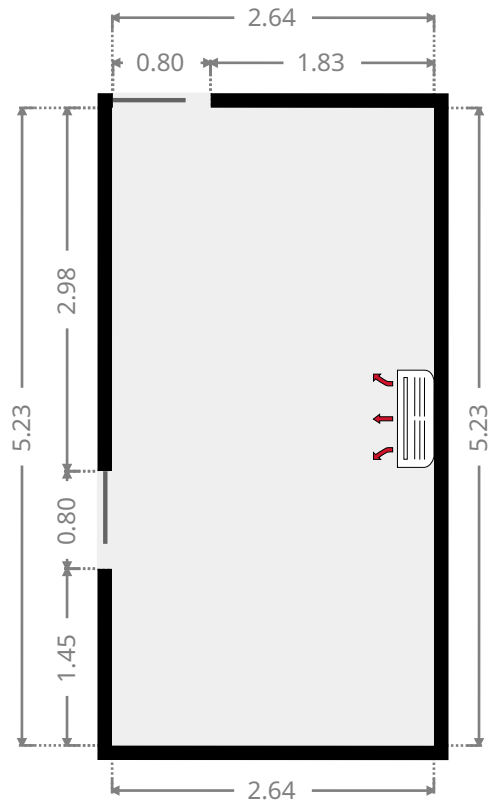
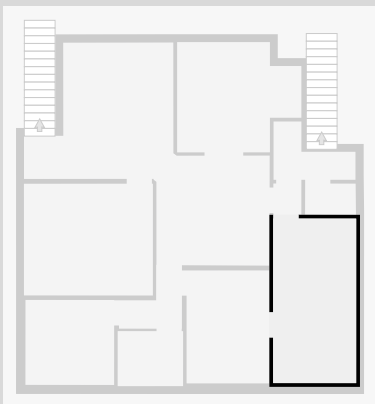

THIS FLOORPLAN IS PROVIDED WITHOUT WARRANTY OF ANY KIND. SENSOPIA DISCLAIMS ANY WARRANTY INCLUDING, WITHOUT LIMITATION, SATISFACTORY QUALITY OR ACCURACY OF DIMENSIONS.

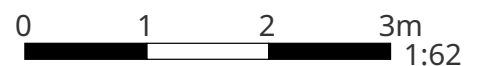

51 Earl Street

Hall

Width: 1.85 m
 Length: 2.60 m
 Area: 3.17 m²
 Perimeter: 8.91 m

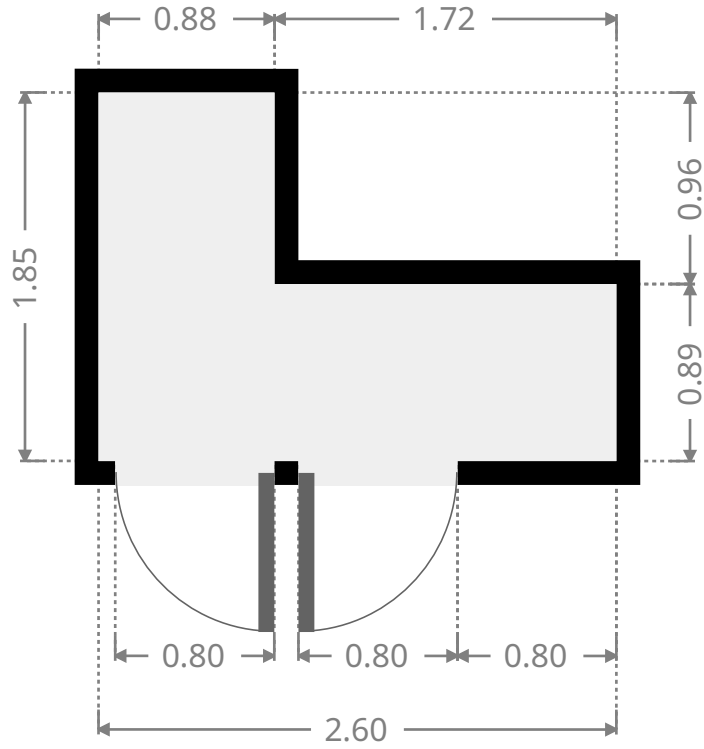
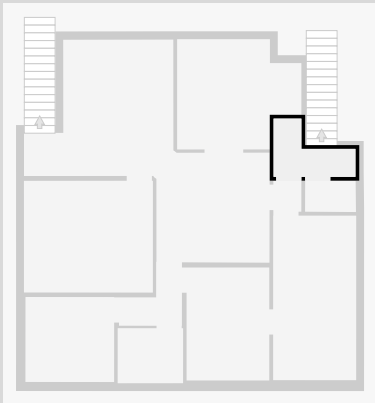

Toilet / Half Bath

Width: 1.00 m
 Length: 1.62 m
 Area: 1.60 m²
 Perimeter: 5.21 m

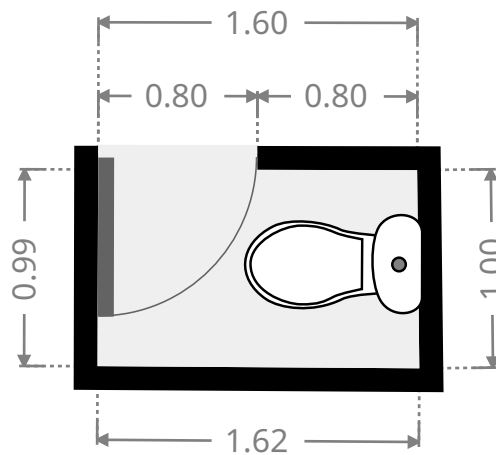
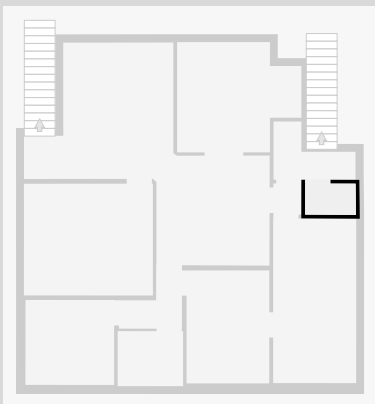

THIS FLOORPLAN IS PROVIDED WITHOUT WARRANTY OF ANY KIND. SENSOPIA DISCLAIMS ANY WARRANTY INCLUDING, WITHOUT LIMITATION, SATISFACTORY QUALITY OR ACCURACY OF DIMENSIONS.

