

Ground Floor

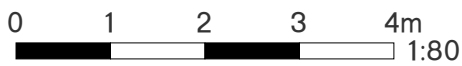
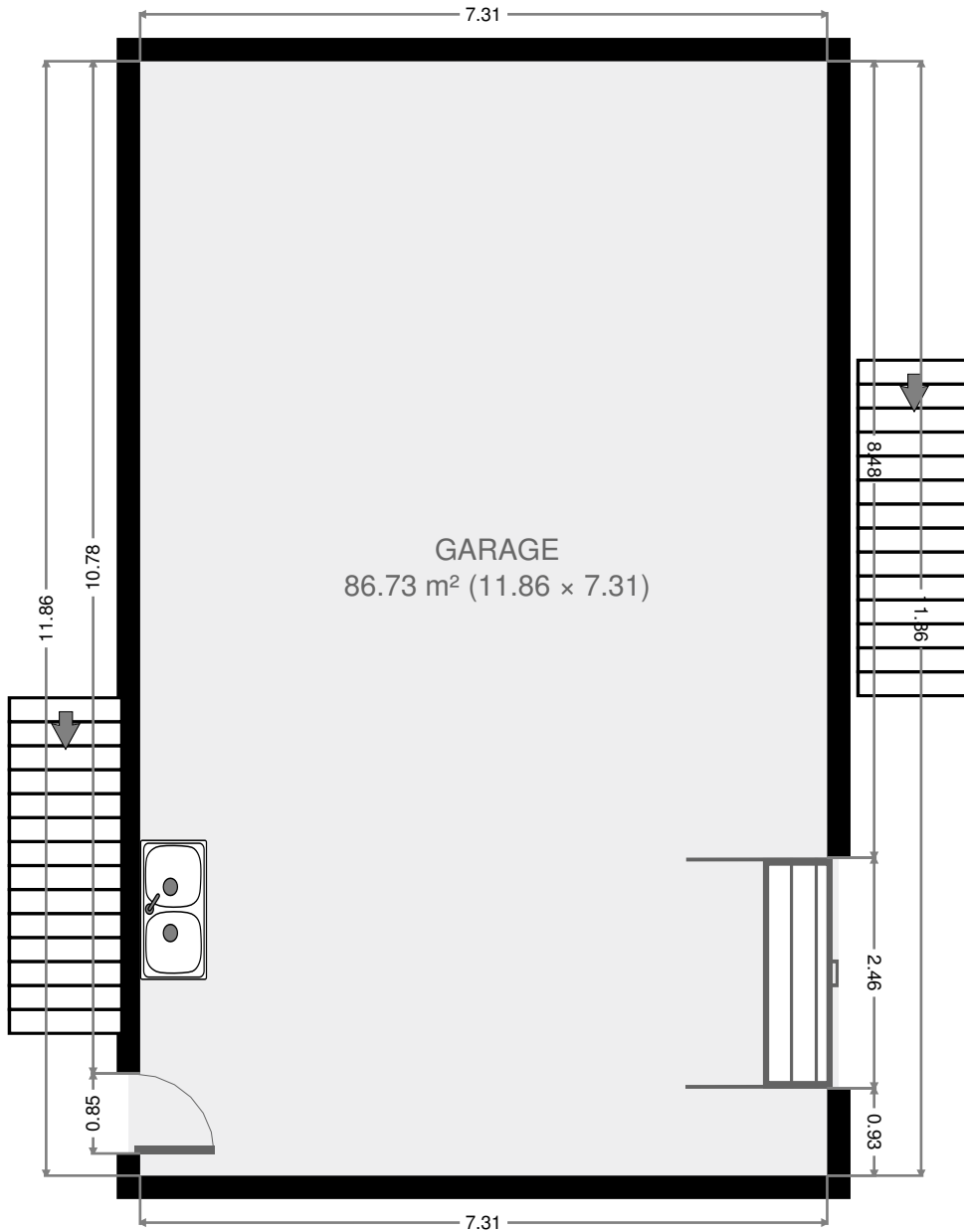

THIS FLOORPLAN IS PROVIDED WITHOUT WARRANTY OF ANY KIND. SENSOPIA DISCLAIMS ANY WARRANTY INCLUDING, WITHOUT LIMITATION, SATISFACTORY QUALITY OR ACCURACY OF DIMENSIONS.

150 Hyde Street

Garage

Width: 7.31 m
Length: 11.86 m
Area: 86.73 m²
Perimeter: 38.35 m

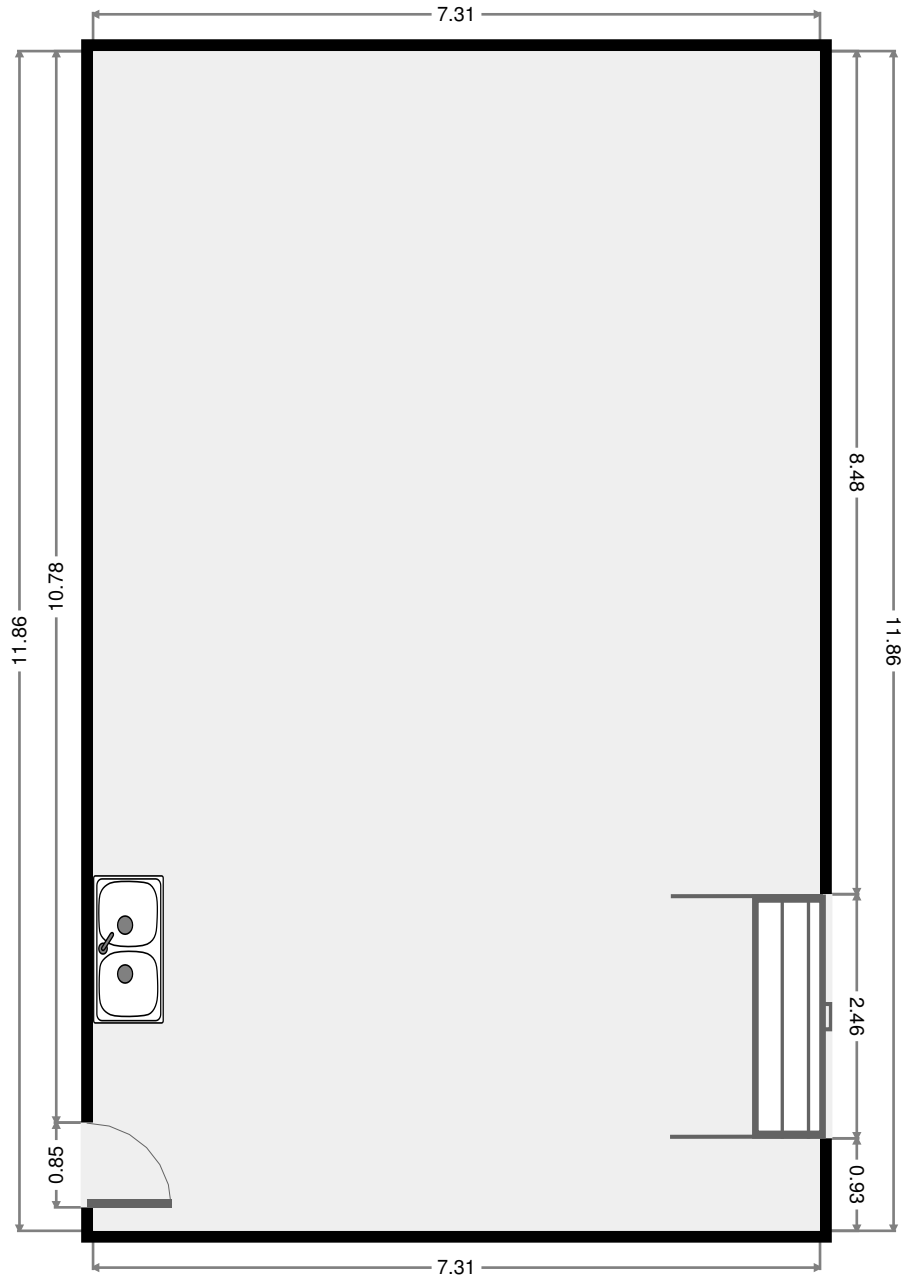
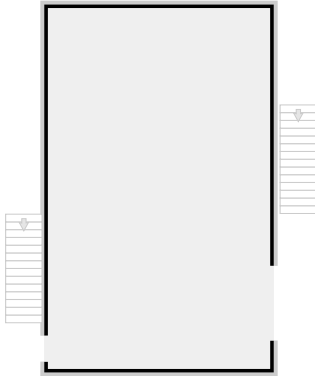

THIS FLOORPLAN IS PROVIDED WITHOUT WARRANTY OF ANY KIND. SENSOPIA DISCLAIMS ANY WARRANTY INCLUDING, WITHOUT LIMITATION, SATISFACTORY QUALITY OR ACCURACY OF DIMENSIONS.

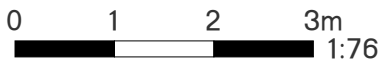

150 Hyde Street

2017-01-10

1st Floor

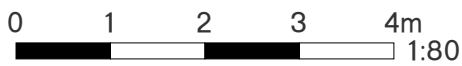
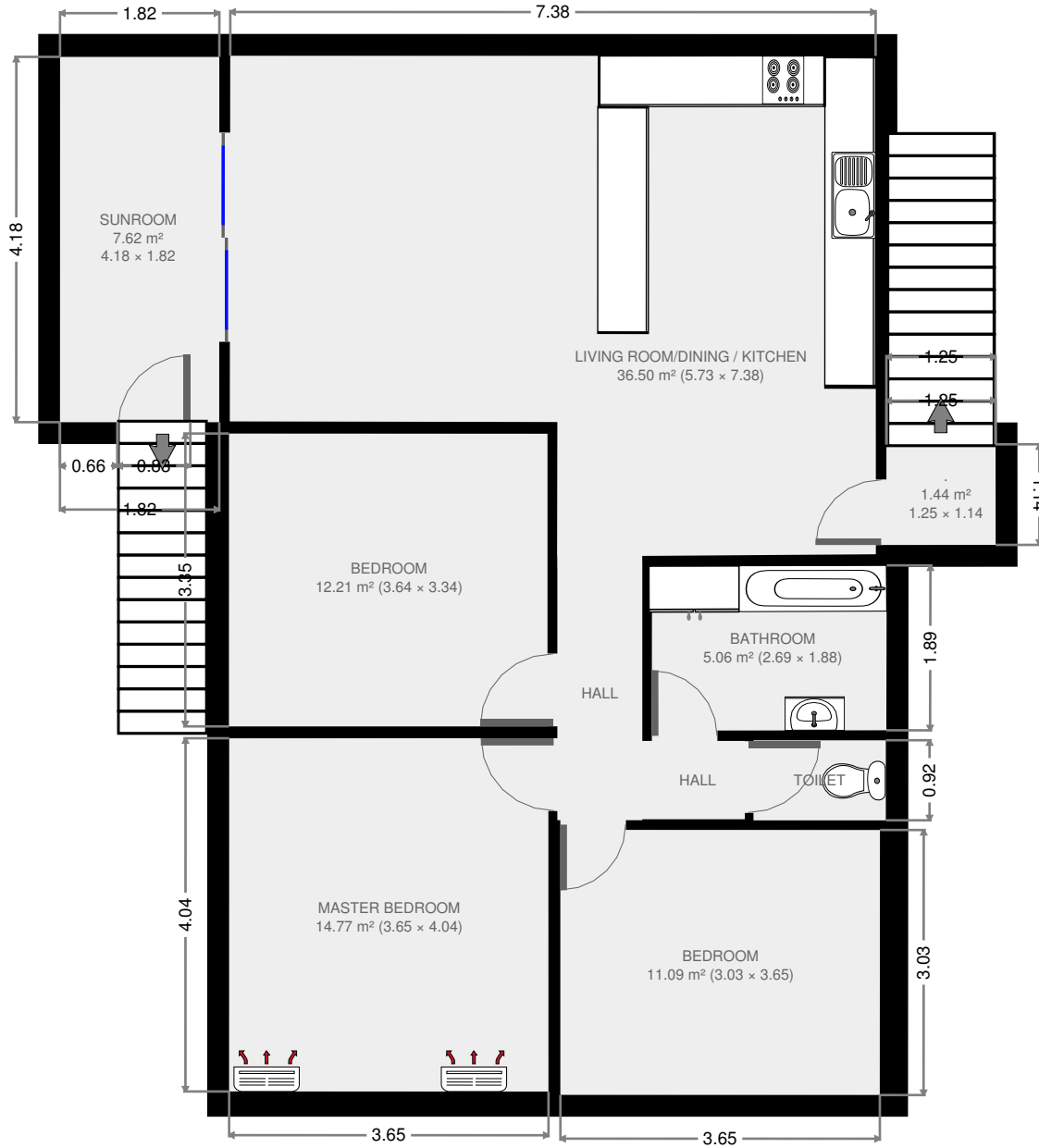

150 Hyde Street

THIS FLOORPLAN IS PROVIDED WITHOUT WARRANTY OF ANY KIND. SENSOPIA DISCLAIMS ANY WARRANTY INCLUDING, WITHOUT LIMITATION, SATISFACTORY QUALITY OR ACCURACY OF DIMENSIONS.

Sunroom

Width: 1.82 m
 Length: 4.18 m
 Area: 7.62 m²
 Perimeter: 12.01 m

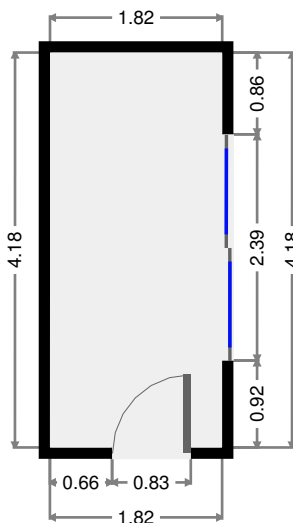
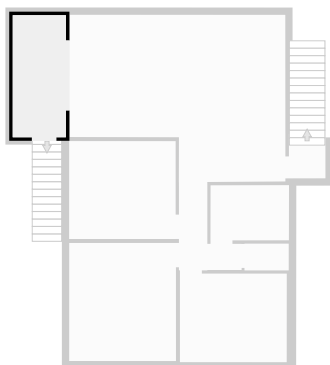

Living Room/Dining / Kitchen

Width: 5.73 m
 Length: 7.38 m
 Area: 36.50 m²
 Perimeter: 26.20 m
 Ceiling Height: 2.17 m

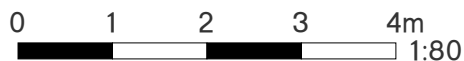
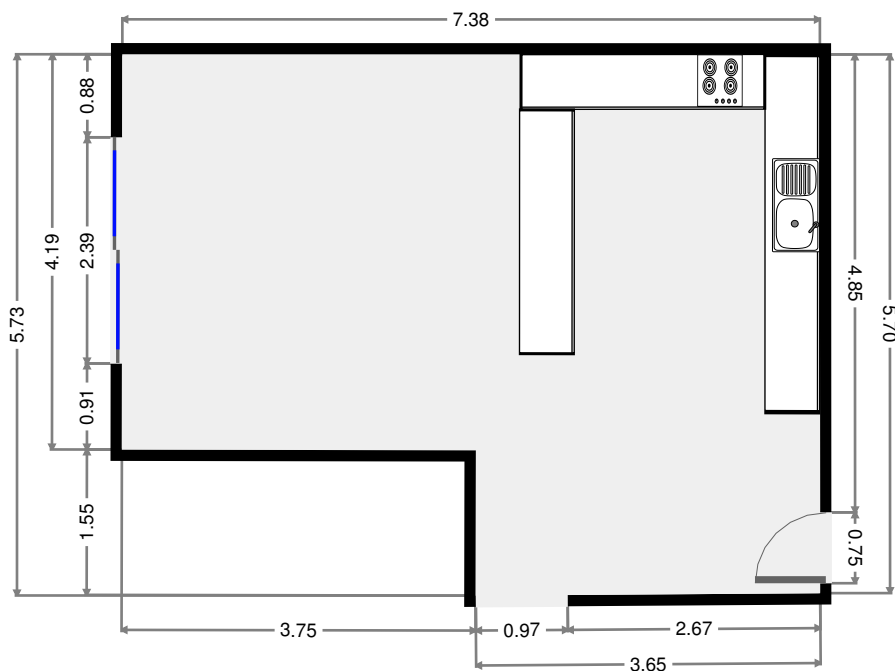
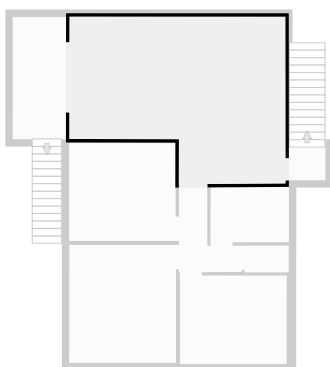

THIS FLOORPLAN IS PROVIDED WITHOUT WARRANTY OF ANY KIND. SENSOPIA DISCLAIMS ANY WARRANTY INCLUDING, WITHOUT LIMITATION, SATISFACTORY QUALITY OR ACCURACY OF DIMENSIONS.

Hall

Width: 0.98 m
 Length: 2.91 m
 Area: 2.82 m²
 Perimeter: 7.76 m

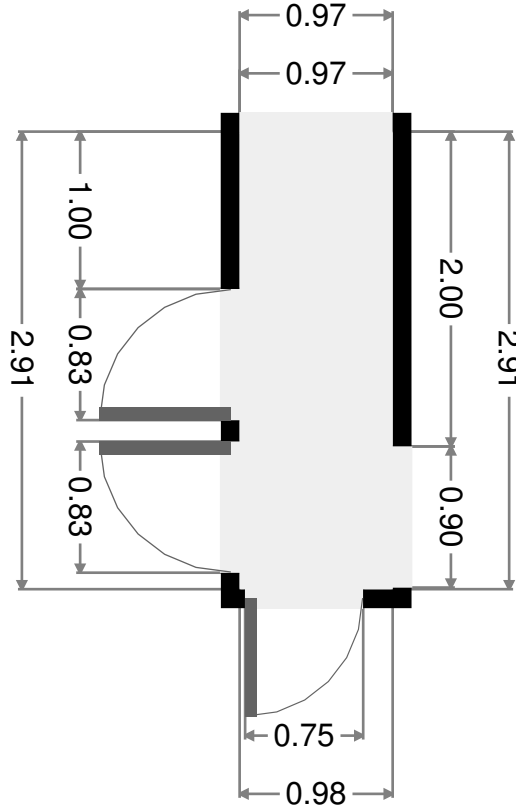
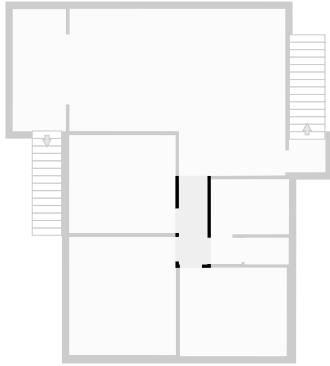

Bedroom

Width: 3.34 m
 Length: 3.64 m
 Area: 12.21 m²
 Perimeter: 13.99 m

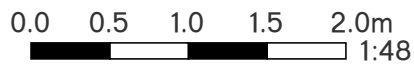
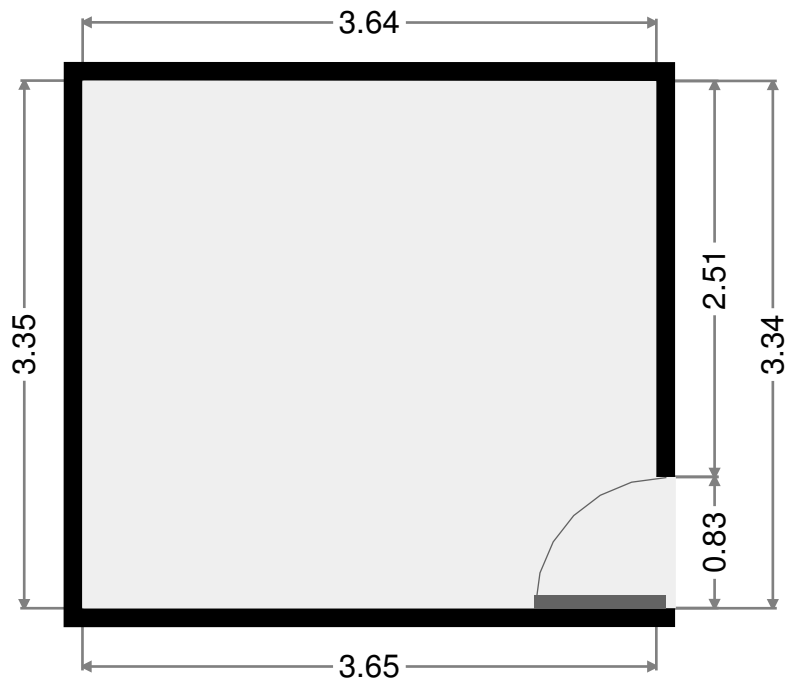
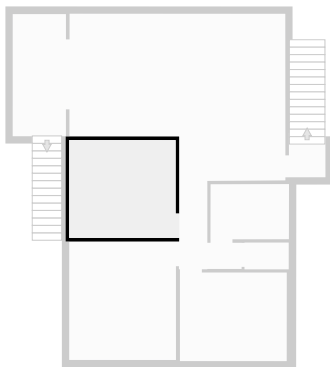

THIS FLOORPLAN IS PROVIDED WITHOUT WARRANTY OF ANY KIND. SENSOPIA DISCLAIMS ANY WARRANTY INCLUDING, WITHOUT LIMITATION, SATISFACTORY QUALITY OR ACCURACY OF DIMENSIONS.

Master Bedroom

Width: 3.65 m
 Length: 4.04 m
 Area: 14.77 m²
 Perimeter: 15.39 m

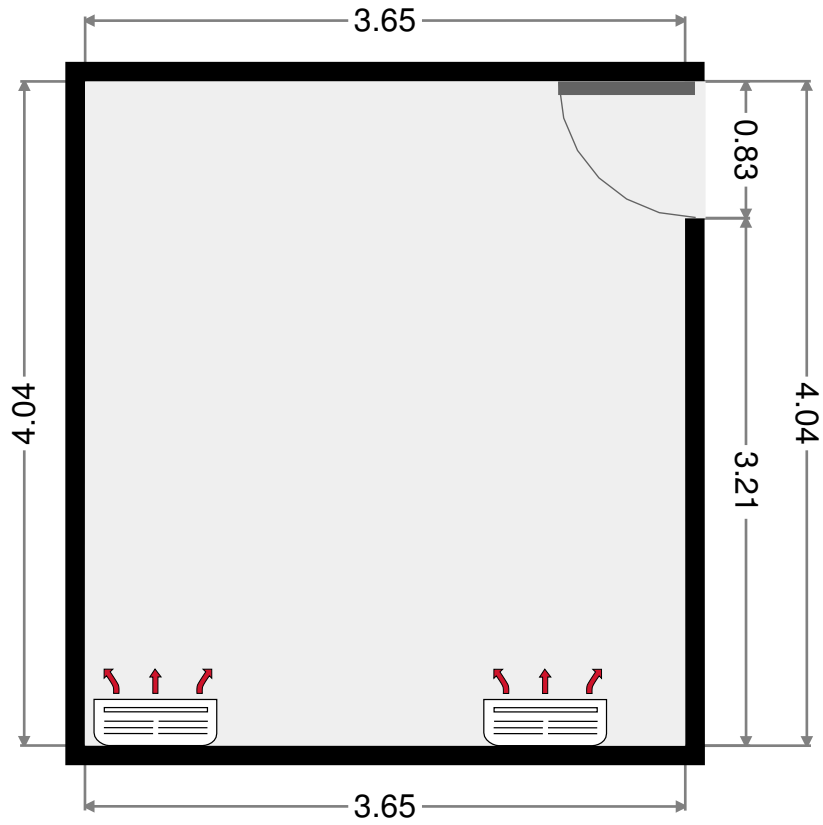
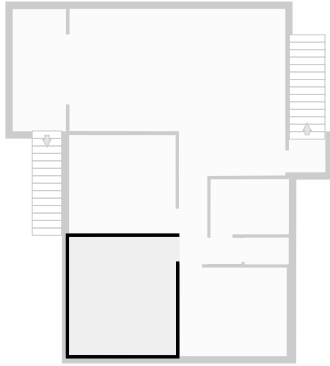

Bedroom

Width: 3.03 m
 Length: 3.65 m
 Area: 11.09 m²
 Perimeter: 13.38 m

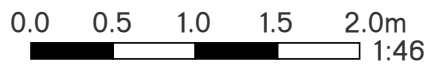
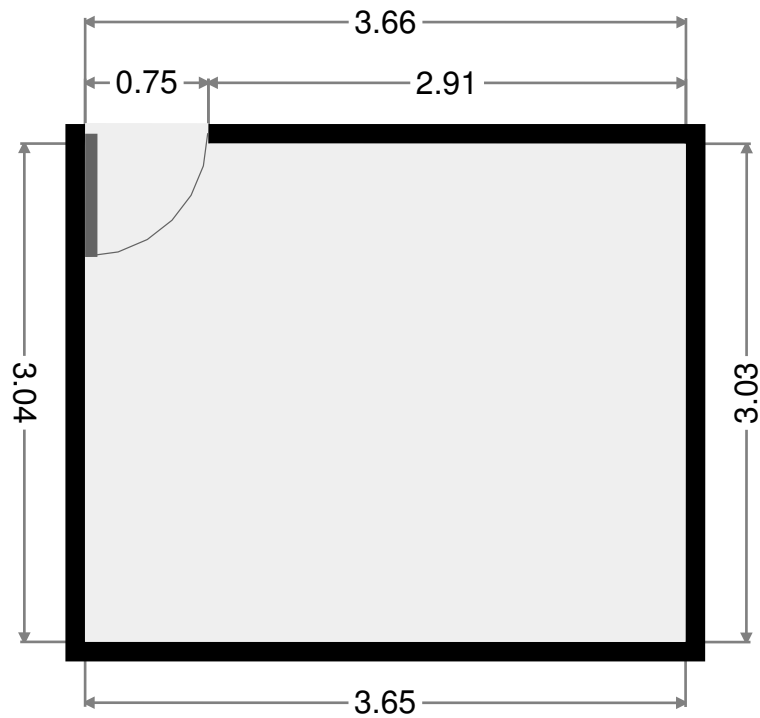
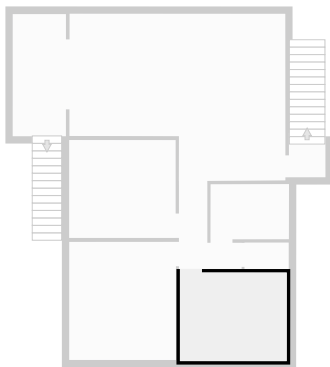

THIS FLOORPLAN IS PROVIDED WITHOUT WARRANTY OF ANY KIND. SENSOPIA DISCLAIMS ANY WARRANTY INCLUDING, WITHOUT LIMITATION, SATISFACTORY QUALITY OR ACCURACY OF DIMENSIONS.

Hall

Width: 0.90 m
 Length: 1.09 m
 Area: 0.97 m²
 Perimeter: 3.95 m

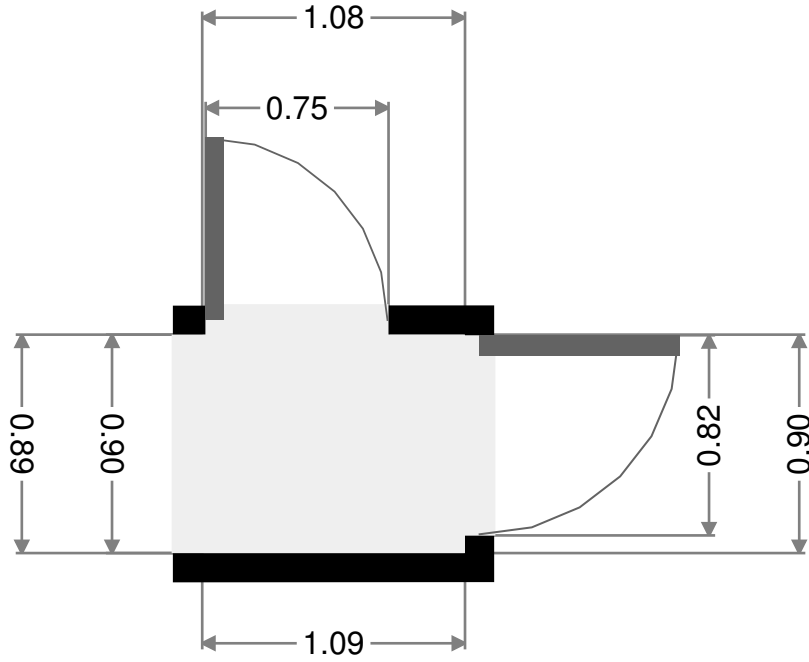
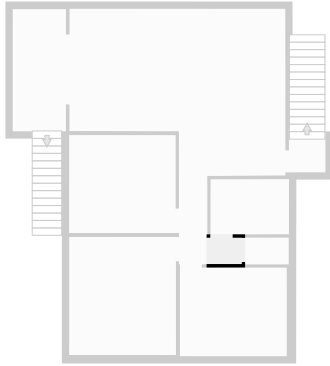

Toilet

Width: 0.92 m
 Length: 1.52 m
 Area: 1.39 m²
 Perimeter: 4.86 m

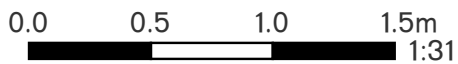
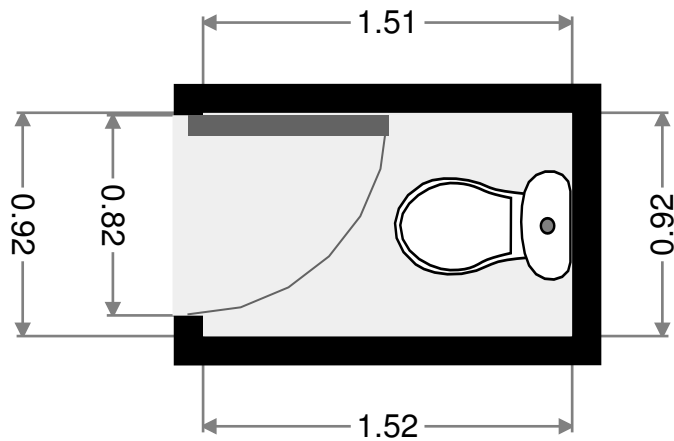
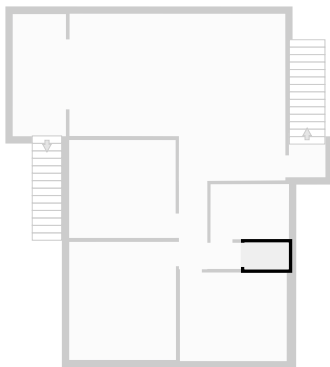

THIS FLOORPLAN IS PROVIDED WITHOUT WARRANTY OF ANY KIND. SENSOPIA DISCLAIMS ANY WARRANTY INCLUDING, WITHOUT LIMITATION, SATISFACTORY QUALITY OR ACCURACY OF DIMENSIONS.

Bathroom

Width: 1.88 m
 Length: 2.69 m
 Area: 5.06 m²
 Perimeter: 9.14 m

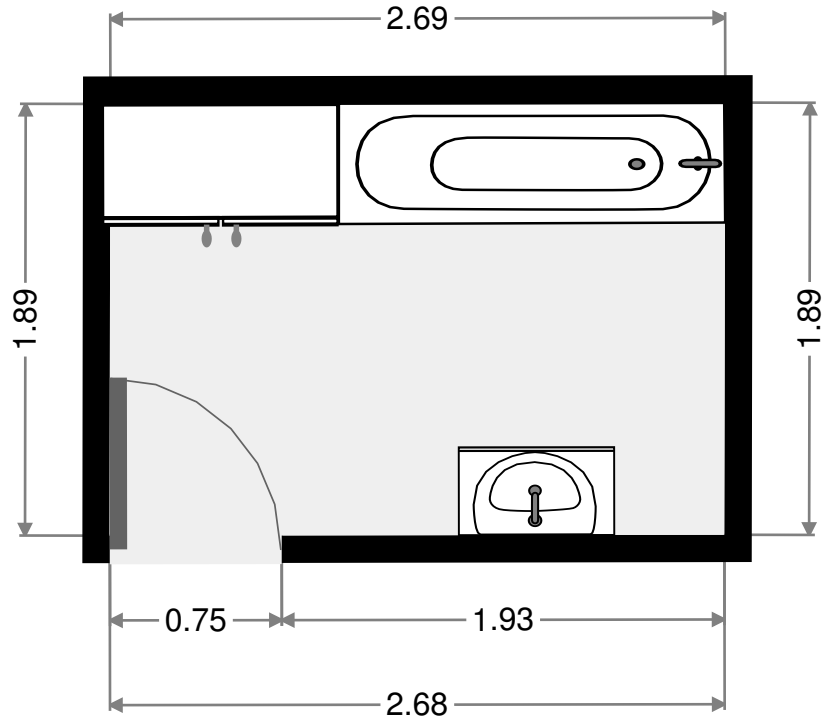
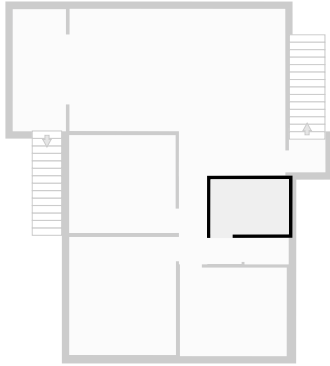

Width: 1.14 m
 Length: 1.25 m
 Area: 1.44 m²
 Perimeter: 4.80 m

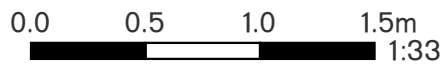
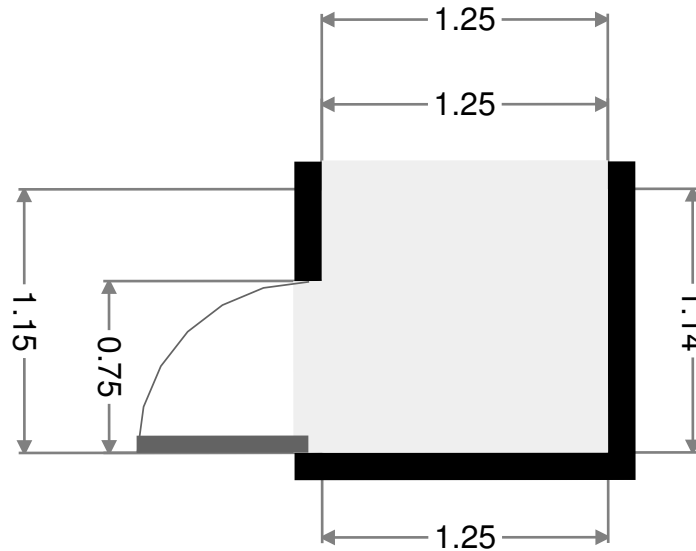
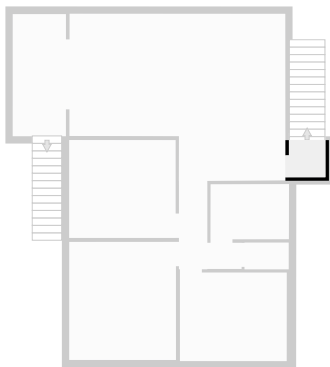

THIS FLOORPLAN IS PROVIDED WITHOUT WARRANTY OF ANY KIND. SENSOPIA DISCLAIMS ANY WARRANTY INCLUDING, WITHOUT LIMITATION, SATISFACTORY QUALITY OR ACCURACY OF DIMENSIONS.