

15 Wittenberg Way

Created on
2021-04-29

Floors
1

▼ Ground Floor

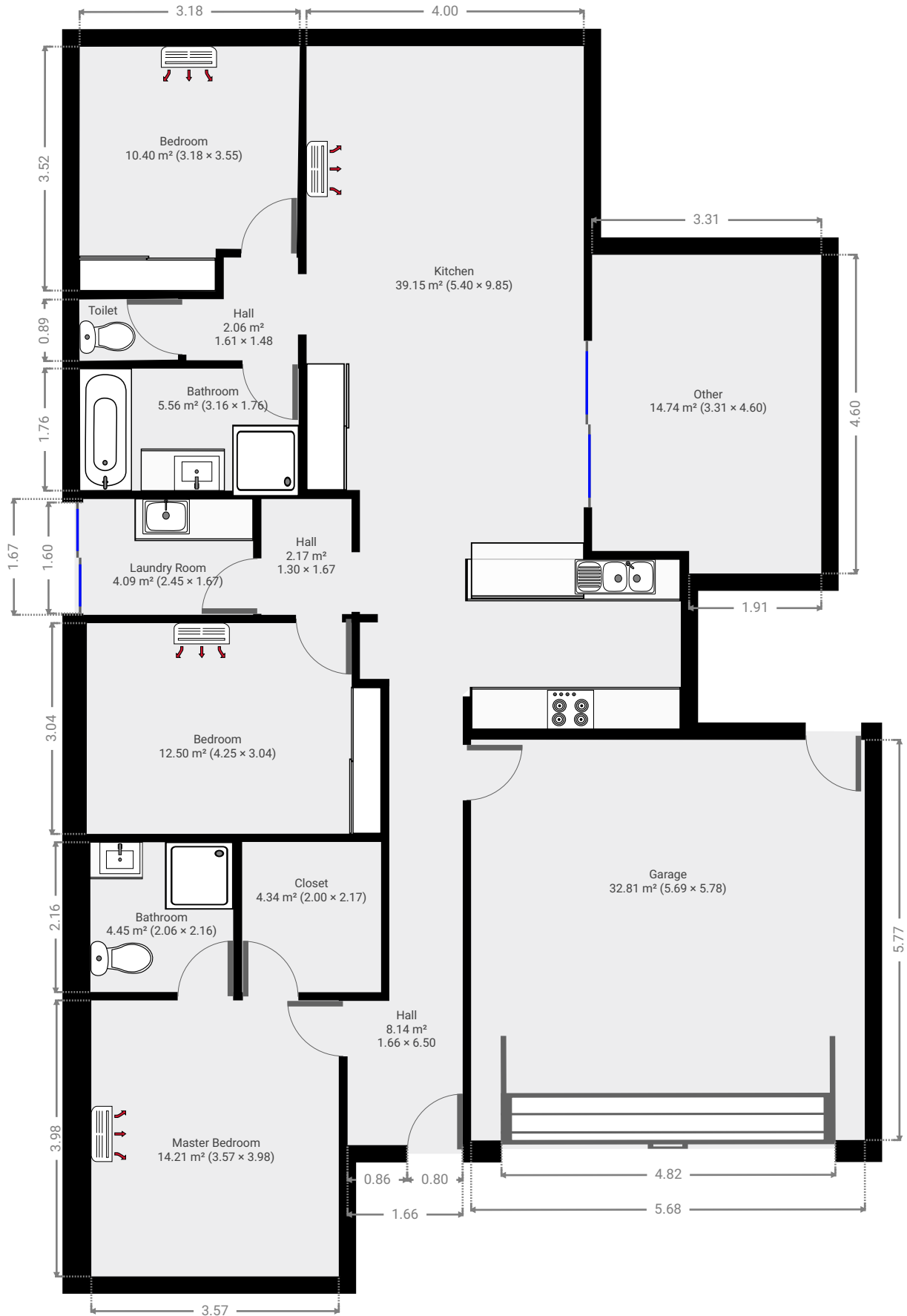

▼ **Hall**
Ground Floor

WIDTH: 1.66 m • LENGTH: 6.50 m
AREA: 8.14 m² • PERIMETER: 16.32 m

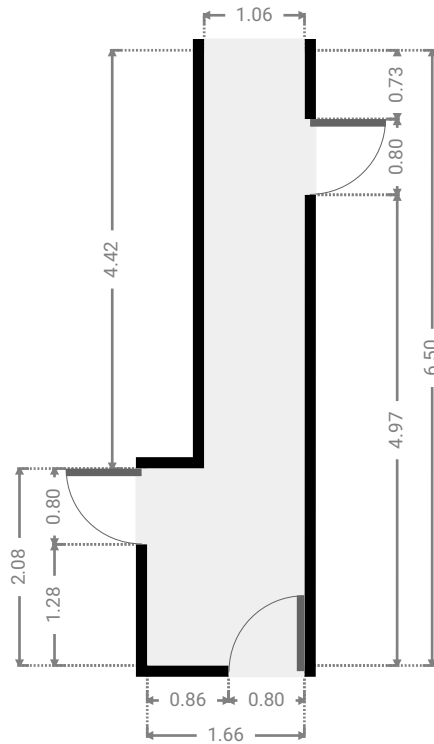
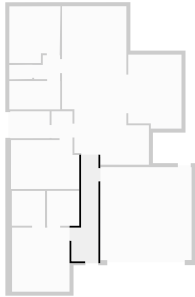

▼ **Master Bedroom**
Ground Floor

WIDTH: 3.57 m • LENGTH: 3.98 m
AREA: 14.21 m² • PERIMETER: 15.10 m

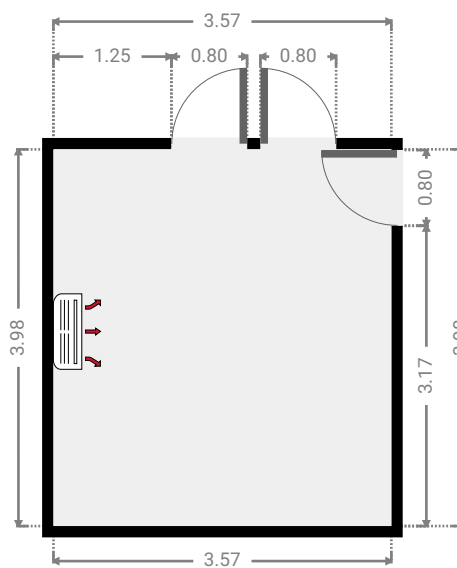

▼ **Bathroom**
Ground Floor

WIDTH: 2.06 m • LENGTH: 2.16 m
AREA: 4.45 m² • PERIMETER: 8.44 m

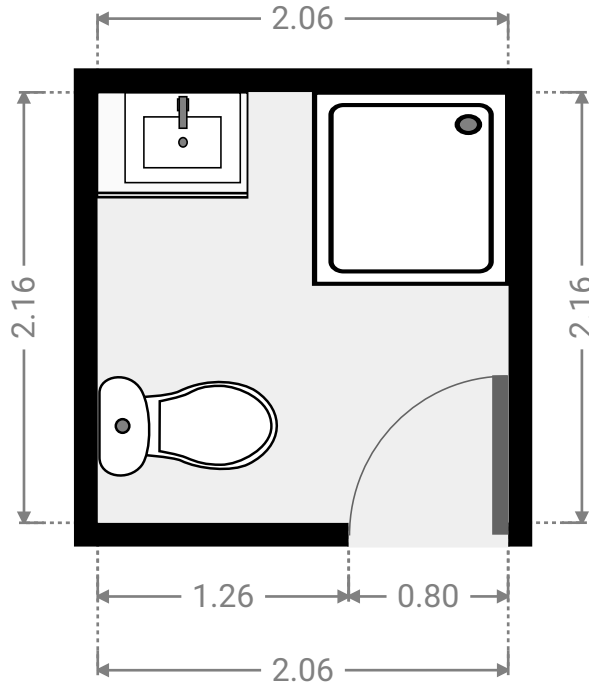
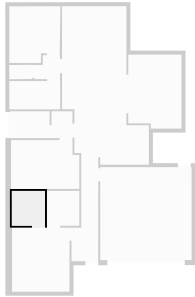

▼ **Closet**
Ground Floor

WIDTH: 2.00 m • LENGTH: 2.17 m
AREA: 4.34 m² • PERIMETER: 8.34 m

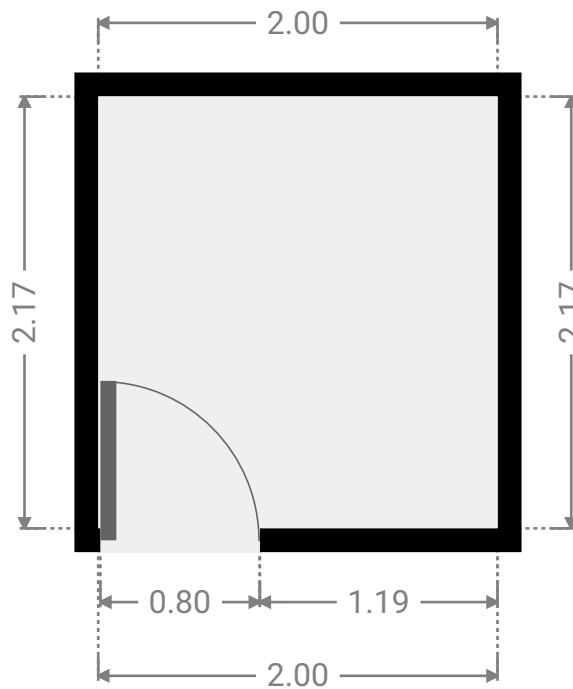
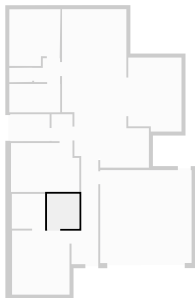

▼ **Garage**
Ground Floor

WIDTH: 5.69 m • LENGTH: 5.78 m
AREA: 32.81 m² • PERIMETER: 22.91 m

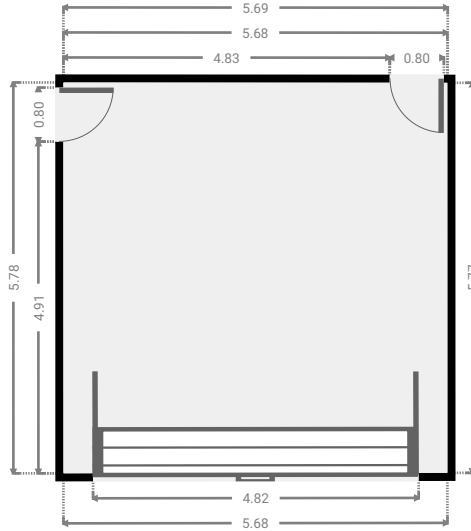
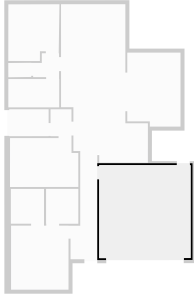

▼ **Kitchen**
Ground Floor

WIDTH: 5.40 m • LENGTH: 9.85 m
AREA: 39.15 m² • PERIMETER: 30.49 m

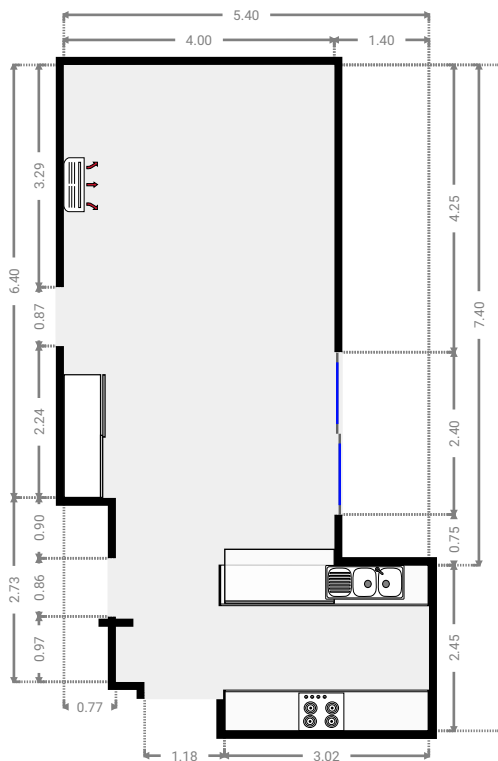
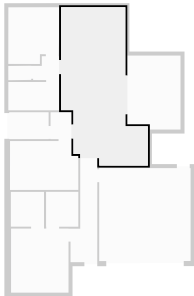

▼ Hall
Ground Floor

WIDTH: 1.30 m • LENGTH: 1.67 m
AREA: 2.17 m² • PERIMETER: 5.94 m

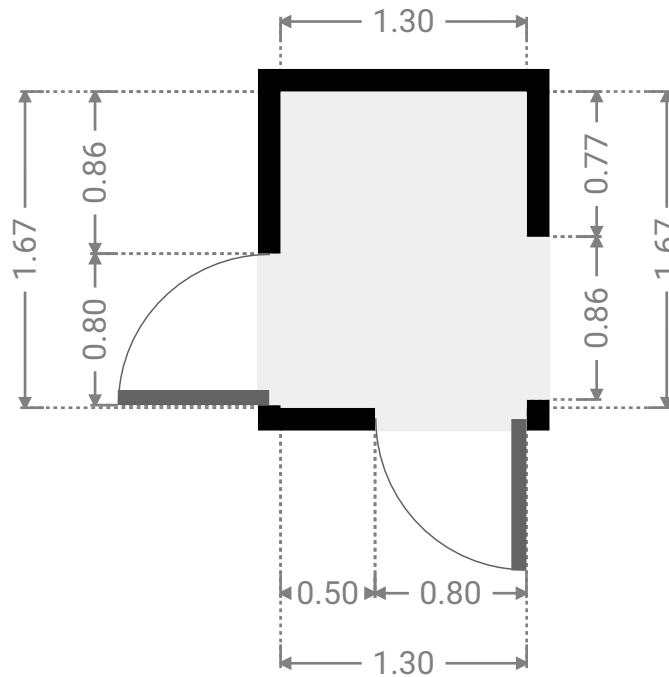
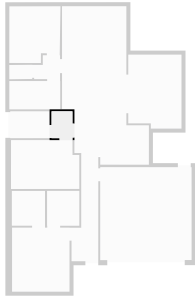

▼ Laundry Room
Ground Floor

WIDTH: 2.45 m • LENGTH: 1.67 m
AREA: 4.09 m² • PERIMETER: 8.24 m

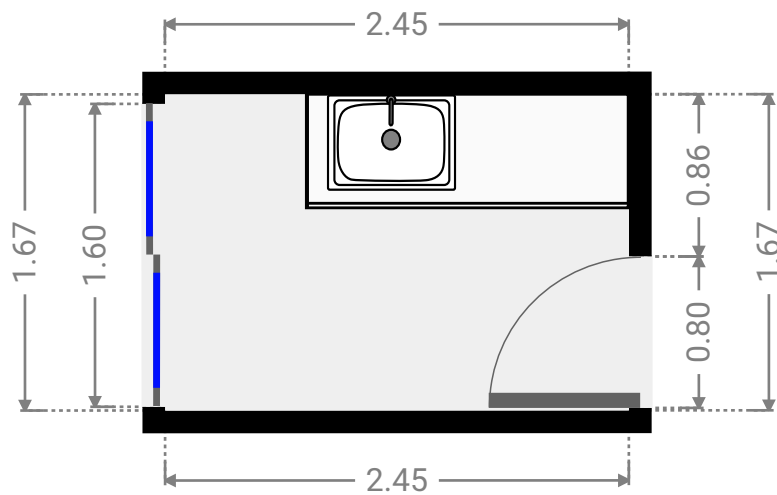
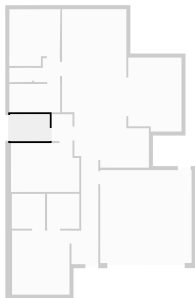

▼ **Bedroom**
Ground Floor

WIDTH: 4.25 m • LENGTH: 3.04 m
AREA: 12.50 m² • PERIMETER: 14.56 m

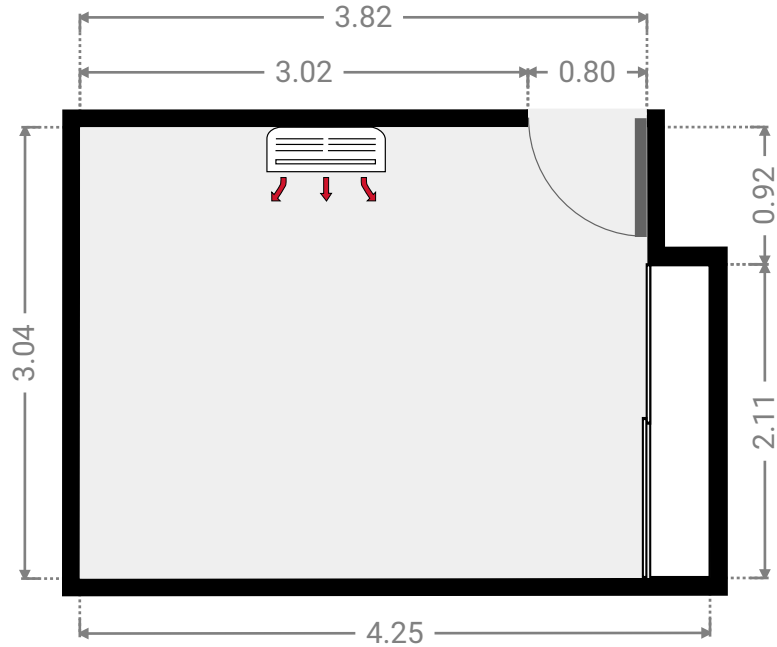
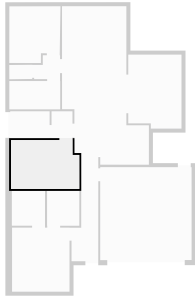

▼ **Hall**
Ground Floor

WIDTH: 1.61 m • LENGTH: 1.48 m
AREA: 2.06 m² • PERIMETER: 6.18 m

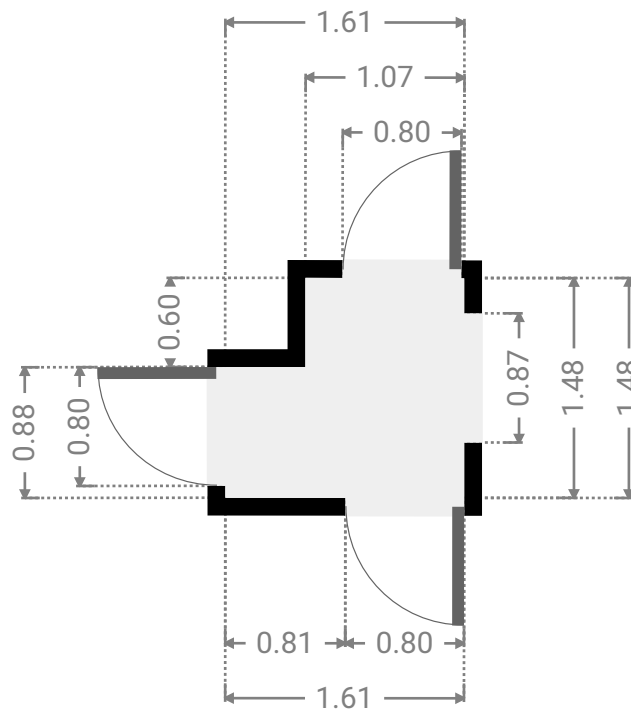
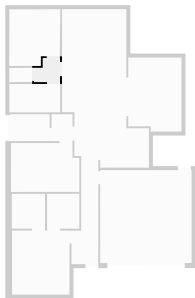

▼ **Bathroom**
Ground Floor

WIDTH: 3.16 m • LENGTH: 1.76 m
AREA: 5.56 m² • PERIMETER: 9.84 m

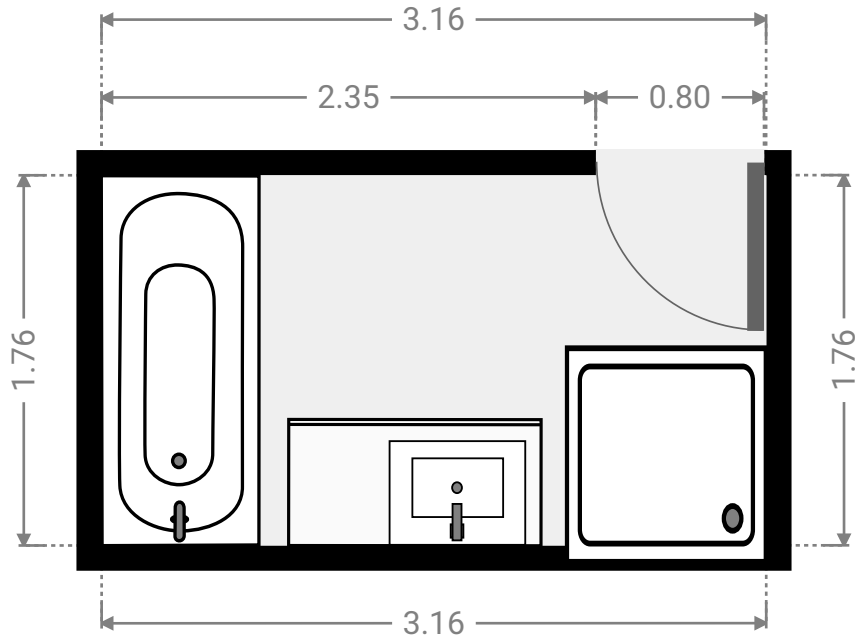
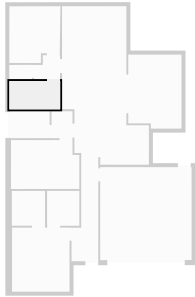

▼ **Toilet**
Ground Floor

WIDTH: 1.43 m • LENGTH: 0.89 m
AREA: 1.26 m² • PERIMETER: 4.61 m

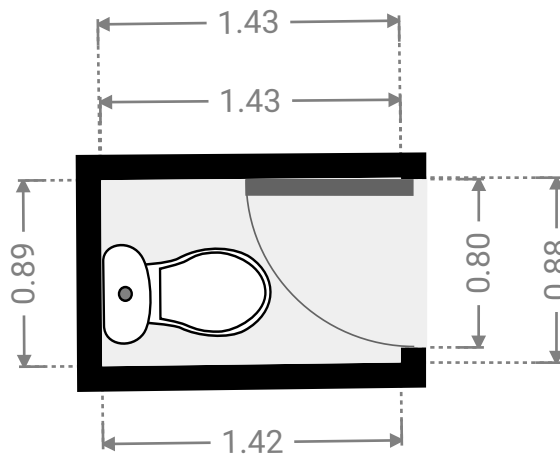
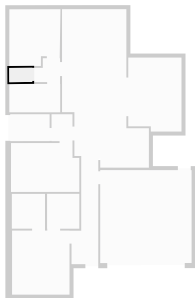

▼ **Bedroom**
Ground Floor

WIDTH: 3.18 m • LENGTH: 3.55 m
AREA: 10.40 m² • PERIMETER: 13.36 m

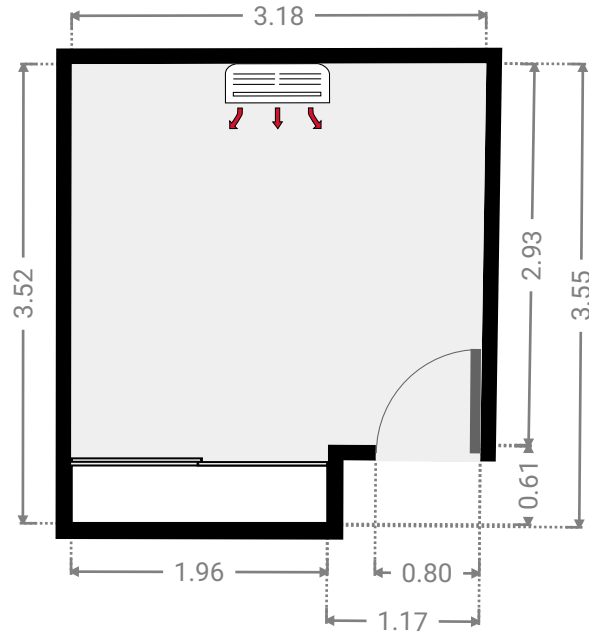
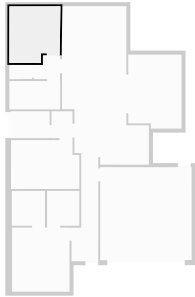

▼ **Other**
Ground Floor

WIDTH: 3.31 m • LENGTH: 4.60 m
AREA: 14.74 m² • PERIMETER: 15.80 m

